

# 11. Highway Design

---

<b>1100.</b>	<b>Introduction.....</b>	<b>1100-1</b>
1100.1.	Establishment of Design Criteria .....	1100-1
1100.2.	Project Design Criteria .....	1100-1
1100.2.1	General.....	1100-1
1100.2.2	Application of Design Criteria.....	1100-1
1100.2.3	New Construction and Reconstruction Project Design Criteria.....	1100-2
1100.2.4	3R Project Design Criteria .....	1100-2
1100.2.5	HSIP Project Design Criteria .....	1100-2
1100.2.6	Preventive Maintenance (PM) Project Design Considerations .....	1100-2
1100.3.	Design Exceptions and Design Waivers .....	1100-2
1100.3.1	General.....	1100-2
1100.3.2	Design Exceptions .....	1100-3
1100.3.3	Design Waivers .....	1100-4
1100.4.	Specific Project Criteria .....	1100-4
1100.4.1	Design Designation.....	1100-4
1100.4.2	Project Design Criteria.....	1100-5
<b>1110.</b>	<b>Reserved</b>	
<b>1120.</b>	<b>Elements of Design .....</b>	<b>1120-1</b>
1120.1.	General .....	1120-2
1120.2.	Interstate.....	1120-2
1120.2.1	General.....	1120-2
1120.2.2	Design Speed.....	1120-2
1120.2.3	Roadway Width .....	1120-2
1120.2.4	Access Control.....	1120-2
1120.3.	Bridges .....	1120-2
1120.3.1	General.....	1120-2
1120.3.2	Design Loads.....	1120-3
1120.3.3	Seismic Design .....	1120-3
1120.3.4	Vertical Clearance .....	1120-3
1120.3.5	Bridge Rail .....	1120-3
1120.3.6	Bridge Decks .....	1120-3
1120.3.7	Bridge Deck Protection.....	1120-3
1120.3.8	Elastomeric Pads.....	1120-3
1120.3.9	Shear Transfer on Skewed Bridges .....	1120-3
1120.4.	Retaining Wall Design .....	1120-7
1120.4.1	General.....	1120-7
1120.4.2	Retaining Wall Classification.....	1120-7
1120.4.3	Federal Requirements, Proprietary Items.....	1120-7
1120.4.4	Wall Selection.....	1120-8
1120.4.5	Wall Design.....	1120-8
1120.4.6	Alternative Wall Designs (Proprietary) .....	1120-8
1120.4.7	Contract Plans.....	1120-9
1120.5.	Drainage .....	1120-9
1120.5.1	Cross Drainage Culverts.....	1120-9
1120.5.2	Storm Sewers.....	1120-9

1120.5.3	<i>Filter Courses or Subsurface Drainage Matting</i> .....	1120-11
1120.5.4	<i>Hydraulic Site Surveys</i> .....	1120-11
1120.5.5	<i>Hydrologic and Hydraulic Standards</i> .....	1120-12
1120.5.6	<i>Hydrologic and Hydraulic Reports</i> .....	1120-12
1120.5.7	<i>Summary Hydraulic Report</i> .....	1120-15
1120.5.8	<i>Hydrologic and Hydraulic Summary</i> .....	1120-15
1120.6.	Turnouts .....	1120-18
1120.6.1	<i>Types</i> .....	1120-18
1120.6.2	<i>References</i> .....	1120-18
1120.6.3	<i>Accessibility</i> .....	1120-18
1120.7.	Erosion & Sediment Control Plans (ESCPs).....	1120-23
1120.7.1	<i>Background</i> .....	1120-23
1120.7.2	<i>ESCP Policy</i> .....	1120-23
1120.7.3	<i>ESCP Development</i> .....	1120-23
1120.7.4	<i>Payment for Erosion, Sediment, and Pollution Control</i> .....	1120-25

**1130. Cross Sections ..... 1130-1**

1130.1.	Roadway Surfaces .....	1130-1
1130.1.1	<i>Vertical Clearance</i> .....	1130-1
1130.1.2	<i>Cross-Slopes</i> .....	1130-1
1130.1.3	<i>Lane and Shoulder Widths</i> .....	1130-1
1130.2.	Roadside Geometry .....	1130-1
1130.2.1	<i>General</i> .....	1130-1
1130.2.2	<i>Low-Speed Roadways</i> .....	1130-1
1130.2.3	<i>Clear Roadside Concept</i> .....	1130-2
1130.2.4	<i>Clear Zones on Horizontal Curves</i> .....	1130-3
1130.2.5	<i>Clear Zones on Slopes Steeper Than 4:1</i> .....	1130-3
1130.3.	Sideslopes, Roadway Sections, and Drainage Channels .....	1130-4
1130.3.1	<i>Transverse Sideslopes</i> .....	1130-4
1130.3.2	<i>Roadway Sections</i> .....	1130-4
1130.3.3	<i>Ditches and Drainage Channels</i> .....	1130-4
1130.4.	Mailboxes .....	1130-4
1130.5.	Traffic Barriers.....	1130-16
1130.5.1	<i>Introduction</i> .....	1130-16
1130.5.2	<i>Guardrails</i> .....	1130-16
1130.5.3	<i>Median Barriers</i> .....	1130-18
1130.5.4	<i>Bridge Rails</i> .....	1130-19
1130.5.5	<i>Crash Cushions</i> .....	1130-19
1130.6.	<i>Guardrail End Terminal Replacement</i> .....	1130-19
1130.6.	Cost-Effective Analysis.....	1130-31
1130.6.1	<i>General</i> .....	1130-31
1130.6.2	<i>Procedures</i> .....	1130-31
1130.7.	Pedestrian Crossings.....	1130-34
1130.7.1	<i>Separation Structures for Pedestrian Crossings</i> .....	1130-34

**1140. Preservation Projects..... 1140-1**

1140.1.	Introduction .....	1140-1
1140.2.	Project identification .....	1140-1
1140.3.	Project Scope.....	1140-1
1140.3.1.	<i>Preventive Maintenance Projects</i> .....	1140-2
1140.3.2.	<i>1R Projects</i> .....	1140-2
1140.3.3.	<i>2R Projects</i> .....	1140-2

1140.4.	Project Development and Design.....	1140-3
1140.4.1.	<i>Pavement Design</i> .....	1140-3
1140.4.2.	<i>Bridge Work</i> .....	1140-4
1140.4.3.	<i>ADA Improvements</i> .....	1140-4
1140.4.4.	<i>Design Study Report (DSR)</i> .....	1140-5
1140.5.	References.....	1140-5
<b>1150.</b>	<b>Urban Roads.....</b>	<b>1150-1</b>
1150.1.	Urban Streets Roadway Width Guidelines.....	1150-1
1150.2.	Urban Arterials.....	1150-1
1150.2.1	<i>General Design Considerations</i> .....	1150-1
1150.2.2	<i>Medians</i> .....	1150-1
<b>1160.</b>	<b>Resurfacing, Restoration, &amp; Rehabilitation Projects.....</b>	<b>1160-1</b>
1160.1.	Guidelines.....	1160-1
1160.1.1	<i>General</i> .....	1160-1
1160.1.2	<i>Background</i> .....	1160-1
1160.1.3	<i>Definition</i> .....	1160-1
1160.1.4	<i>Determining the Type of Project</i> .....	1160-1
1160.2.	Factors.....	1160-1
1160.3.	3R Geometric Design Standards.....	1160-3
1160.3.1	<i>General (Design Exceptions)</i> .....	1160-3
1160.3.2	<i>Lane and Shoulder Widths</i> .....	1160-3
1160.3.3	<i>Horizontal Curves</i> .....	1160-14
1160.3.4	<i>Vertical Curvature and Stopping Sight Distance</i> .....	1160-14
1160.3.5	<i>Bridges</i> .....	1160-15
1160.3.6	<i>Sideslopes and Clear Zones</i> .....	1160-16
1160.3.7	<i>Pavement Edge Drop</i> .....	1160-16
1160.3.8	<i>Intersections</i> .....	1160-16
1160.3.9	<i>Driveways</i> .....	1160-16
1160.3.10	<i>Passing Sight Distance</i> .....	1160-20
1160.3.11	<i>Grades</i> .....	1160-20
1160.3.12	<i>Safety Mitigation</i> .....	1160-20
1160.4.	Studies.....	1160-20
1160.4.1	<i>Design Study Report</i> .....	1160-20
1160.5.	Gravel to Pavement.....	1160-20
1160.5.1	<i>General</i> .....	1160-20
1160.5.2	<i>Design Year</i> .....	1160-20
1160.5.3	<i>Design Speed</i> .....	1160-20
1160.5.4	<i>Lane and Shoulder Widths</i> .....	1160-21
1160.5.5	<i>Grades</i> .....	1160-22
1160.5.6	<i>Horizontal Curves</i> .....	1160-22
1160.5.7	<i>Vertical Curvatures and Stopping Sight Distance</i> .....	1160-22
1160.5.8	<i>Bridges</i> .....	1160-22
1160.5.9	<i>Clear Zones</i> .....	1160-22
1160.5.10	<i>Bicycles</i> .....	1160-22
1160.5.11	<i>ADA</i> .....	1160-22
1160.5.12	<i>Design Study Report</i> .....	1160-22
<b>1170.</b>	<b>Special Design Elements.....</b>	<b>1170-1</b>
1170.1.	Roadway Illumination.....	1170-1
1170.2.	Bus Stops.....	1170-1

1170.3.	Bus and HOV (High Occupancy Vehicle) Lane .....	1170-1
1170.4.	Boardwalks .....	1170-1
1170.5.	Boat Ramps .....	1170-2
1170.5.1.	General.....	1170-2
1170.5.2.	Grades .....	1170-2
1170.5.3.	Alignment .....	1170-2
1170.5.4.	Surface.....	1170-2
1170.5.5.	Other Considerations .....	1170-2
1170.6.	Airway-Highway Clearances .....	1170-2
1170.7.	Highway Signs, Luminaires Traffic Signals, Poles, and Posts.....	1170-3
1170.7.1.	General.....	1170-3
1170.7.2.	Sign Supports.....	1170-3
1170.7.3.	Breakaway Supports.....	1170-3
1170.7.4.	Large Roadside Signs.....	1170-3
1170.7.5.	Small Roadside Signs .....	1170-3
1170.7.6.	Multiple Post Supports for Sign Supports .....	1170-4
1170.7.7.	Signal Poles.....	1170-4
1170.8.	Fencing.....	1170-4
1170.8.1.	Introduction.....	1170-4
1170.8.2.	Functions.....	1170-4
1170.8.3.	Types.....	1170-4
1170.8.4.	Design Considerations .....	1170-5
1170.8.5.	Other Considerations .....	1170-6
1170.8.6.	References .....	1170-6

**1180. Pavement Design..... 1180-1**

1180.1.	Introduction .....	1180-1
1180.2.	Pavement Overview .....	1180-1
1180.2.1	Pavement Structure .....	1180-1
1180.2.2	Highway Pavements .....	1180-1
1180.2.3	Non-Highway Pavements .....	1180-1
1180.3.	Wearing Course.....	1180-1
1180.3.1	Hot Mix Asphalt (HMA) .....	1180-1
1180.3.2	Asphalt Surface Treatment (AST).....	1180-2
1180.3.3	Portland Cement Concrete (PCC) .....	1180-2
1180.3.4	Gravel Surfacing .....	1180-2
1180.4.	Binder Course.....	1180-2
1180.4.1	Hot Mixed Asphalt (HMA) .....	1180-2
1180.4.2	Recycled Asphalt Pavement.....	1180-2
1180.5.	Base Course.....	1180-2
1180.5.1	Stabilized Bases.....	1180-3
1180.5.2	Non-Stabilized Bases.....	1180-3
1180.6.	Subbase/Select Material/Borrow .....	1180-3
1180.7.	Gravel Roads .....	1180-4
1180.7.1	General.....	1180-4
1180.7.2	Gravel Surface Structure.....	1180-4
1180.8.	Glossary.....	1180-4

**1190. Driveway Standards ..... 1190-1**

1190.1.	General .....	1190-1
1190.2.	Definitions.....	1190-1
1190.3.	Functional Classification.....	1190-2



1190.4. General Principles ..... 1190-2  
1190.5. Control Dimensions..... 1190-6

## Figures, Tables, Examples, and Exhibits

Figure 1100-1	Design Designation Form.....	1100-6
Figure 1100-2(a)	Project Design Criteria For New Construction and Reconstruction Projects.....	1100-7
Figure 1100-2(b)	Project Design Criteria For 3(R) Projects .....	1100-9
Figure 1100-3a	Highway Design Criteria Summary .....	1100-11
Figure 1100-3b	Highway Design Criteria Summary .....	1100-12
Figure 1120-1	Horizontal Curve, Grade, and Sight Distance Criteria Summary.....	1120-3
Figure 1120-2	Design Speeds on Low-Speed Paved Streets and Turning Roadways.....	1120-4
Figure 1120-3	Design Speeds on Low-Speed Gravel Streets and Turning Roadways.....	1120-5
Figure 1120-4	Recommended Minimum Truck Emergency Turnout.....	1120-18
Figure 1120-5	Slow Vehicle Turnout for Rural Two-Lane Roadways.....	1120-19
Figure 1120-6	Recommended Minimum Scenic Viewpoint.....	1120-20
Figure 1120-7	Recommended Minimum Separated Turnout With 90-Degree Entrances.....	1120-21
Figure 1130-1	Recommended Cross Slopes .....	1130-13
Figure 1130-2	Horizontal Curve Clear Zone Widening Option for Accident Mitigation.....	1130-14
Figure 1130-3	Rock Excavation .....	1130-15
Figure 1130-4a	Barrier Advancement Length for G-4S and G-4W Beam Guardrail with Approved End Treatment.....	1130-22
Figure 1130-4b	Rigid Barrier Advancement Length .....	1130-23
Figure 1130-5	Traffic Barrier Advancement Length on Outside of Horizontal Curve Tangent $\leq$ LR.....	1130-24
Figure 1130-6	Traffic Barrier Advancement Length on Outside of Horizontal Curve Tangent $>$ LR .....	1130-25
Figure 1130-7	Traffic Barrier Advancement Length on Inside of Horizontal Curve ..	1130-26
Figure 1130-8a	Barrier Advancement Length at Bridge Approaches (Parallel Wingwalls).....	1130-27
Figure 1130-8b	Barrier Advancement Length at Bridge Approaches (Perpendicular Wingwalls).....	1130-28
Figure 1130-9	Process for Determining Roadside Treatments on New and Reconstruction Projects .....	1130-33
Figure 1140-1	Safe Speeds on Low-Speed Paved Streets and Turning Roadways .....	1140-2
Figure 1140-2	Safe Speeds on Low-Speed Gravel Streets and Turning Roadways .....	1140-3
Figure 1160-1	Rural Roadside Hazard Rating of 1.....	1160-7
Figure 1160-2	Rural Roadside Hazard Rating of 2.....	1160-8
Figure 1160-3	Rural Roadside Hazard Rating of 3.....	1160-9
Figure 1160-4	Rural Roadside Hazard Rating of 4.....	1160-10
Figure 1160-5	Rural Roadside Hazard Rating of 5.....	1160-11
Figure 1160-6	Rural Roadside Hazard Rating of 6.....	1160-12
Figure 1160-7	Rural Roadside Hazard Rating of 7.....	1160-13
Figure 1160-8	Minimum Intersection Sight Distance.....	1160-17

Figure 1170-1a	Boardwalk .....	1170-7
Figure 1170-1b	Boardwalk .....	1170-8
Figure 1170-2	Sign Post Design Specifications.....	1170-9
Figure 1170-3	Wind Isotach for 10-Year Interval .....	1170-10
Figure 1170-4	Wind Isotach for 25-Year Interval .....	1170-11
Figure 1170-5	Wind Isotach for 50-Year Interval .....	1170-12
Figure 1170-6	Sign Post Selection 50 mph Design Wind Velocity.....	1170-13
Figure 1170-7	Sign Post Selection 60 mph Design Wind Velocity.....	1170-14
Figure 1170-8	Sign Post Selection 70 mph Design Wind Velocity.....	1170-15
Figure 1170-9	Sign Post Selection 80 mph Design Wind Velocity.....	1170-16
Figure 1170-10	Sign Post Selection 90 mph Design Wind Velocity.....	1170-17
Figure 1170-11	Sign Post Selection 100 mph Design Wind Velocity.....	1170-18
Figure 1170-12	Large Roadside Sign Supports .....	1170-19
Figure 1190-1	Driveway Sight Distance.....	1190-11
Figure 1190-2	Driveway Definitions .....	1190-12
Figure 1190-3	Driveway Corner Definitions .....	1190-13
Figure 1190-4	Driveway Profiles.....	1190-14
Figure 1190-5	Driveway Profiles With Super .....	1190-15
Figure 1190-6a	Curb Cut Profile .....	1190-16
Figure 1190-6b	Curb Cut Profile .....	1190-17
Figure 1190-7a	Curb Cut Profile .....	1190-18
Figure 1190-7b	Curb Cut Profile .....	1190-19
Table 1100-1	Adopted Design Standards .....	1100-10
Table 1120-1	Design Flood Frequency .....	1120-9
Table 1130-1	Vertical Clearance .....	1130-5
Table 1130-2	Clear Zone Distance .....	1130-6
Table 1130-3	Rural Local Roadway, Lane and Shoulder Widths .....	1130-7
Table 1130-4	Rural Local Roadway, Lane and Shoulder Widths .....	1130-8
Table 1130-5	Rural Collector Roadway, Lane and Shoulder Widths .....	1130-9
Table 1130-6	Rural Collector Roadway, Lane and Shoulder Widths .....	1130-10
Table 1130-7	Rural Arterial Roadway, Lane and Shoulder Widths.....	1130-11
Table 1130-8	Rural Arterial Roadway, Lane and Shoulder Widths.....	1130-12
Table 1130-9	Recommended Shy Line Offsets.....	1130-20
Table 1130-10	Flare Rates for Barrier Design.....	1130-20
Table 1130-11	Recommended Runout Lengths for Barrier Advancement Length Determinations.....	1130-21
Table 1130-12	Guardrail End Treatment Replacement.....	1130-29
Table 1150-1	Auxiliary Lane Length Guidelines .....	1150-2
Table 1150-2	Recommended Median Widths .....	1150-2
Table 1160-1	3R Procedure Outline (Case 1).....	1160-5
Table 1160-2	3R Procedure Outline (Case 2).....	1160-6
Table 1160-3	Accident Rate Factor.....	1160-18
Table 1160-4	Relative Hazard.....	1160-18
Table 1160-5	Constants for Lr.....	1160-19
Table 1160-6	Two-Lane, Two-Way Traffic, Lane and Shoulder Widths .....	1160-21
Table 1190-1	Average Trip Generation Factors .....	1190-5

Table 1190-2	Driveway Return Radii.....	1190-9
Table 1190-3	Distance Between Driveways.....	1190-9
Table 1190-4	Corner Clearance.....	1190-10
Example 1160-1	Lane-Shoulders and X-Section.....	1160-23
Example 1160-2	Lane-Shoulders and X-Section.....	1160-26
Example 1160-3	Horizontal Curve .....	1160-27
Example 1160-4	Cost-Effective Analysis.....	1160-28
Example 1160-5	Vertical Curve .....	1160-29
Exhibit A	Application and Permit to Construct and Maintain Driveways on Public Right-of-Way .....	1190-21

This page intentionally left blank.

## 1100. Introduction

---

- 1100.1. Establishment of Design Criteria
- 1100.2. Project Design Criteria
- 1100.3. Design Exceptions and Design Waivers
- 1100.4. Specific Project Criteria

### 1100.1. Establishment of Design Criteria

Alaska statutes require the Department to establish design standards, and the Federal Highway Administration encourages the development of design standards by states in the interest of uniformity. AS 19.10.160(a) states:

*The Department shall prepare and adopt uniform standard plans and specifications for the establishment, construction, and maintenance of highways in the state. The Department may amend the plans and specifications as it considers advisable. The standards must conform as closely as practicable to those adopted by the American Association of State Highway and Transportation Officials.*

The Federal Highway Administration lists standards, specifications, policies, guides, and references that are approved for use on federal-aid projects in the *Code of Federal Regulations, Title 23 Highways, Part 625 – Design Standards for Highways*.

The *Alaska Highway Preconstruction Manual* (HPCM) establishes or references standards for design of highways by the Department. This manual interprets, amends, and supplements AASHTO standards.

Standards, specifications, policies, guides, and references are routinely revised or replaced with newer versions. The Department does not necessarily and immediately adopt these newer versions. Table 1100-1 lists the version dates formally adopted.

### 1100.2. Project Design Criteria

#### 1100.2.1 General

Use design criteria contained or referenced in this manual. Criteria in this manual takes precedence if there is a conflict between criteria provided in this

manual and criteria in referenced publications. When selecting design criteria, use expertise and judgment to achieve designs that fit into the natural and human environments while considering preservation and enhancement of scenic, aesthetic, historic, community, and environmental resources; while also improving or maintaining safety, efficiency, mobility, operations, and infrastructure conditions. Consider economics, but do not use it as the sole determination for design criteria selection.

Design criteria vary according to the type of project, e.g. new construction, reconstruction, 3R, or PM. The type of project is identified in the planning and scoping of the project. Generally, the type of project is reflected in the project title, scope, description, Project Information Document, and Design Designation. Any questions or inconsistencies regarding the type of project should be resolved with planning and project control as this can affect the applicable design criteria.

In some situations, it may be necessary to use values less than the minimums, or greater than the maximums, provided due to constraints beyond the engineer's control. In such cases, follow the procedures set forth in Section 1100.3. – Design Exceptions and Design Waivers.

Figure 1100-3, Project Criteria Summary, provides design references for New Construction / Reconstruction and 3R projects. The initial design reference may direct the designer to succeeding references.

Use U.S. customary units of measure for all designs.

#### 1100.2.2 Application of Design Criteria

Designers need to recognize that every project is unique and that flexibility in the design standards exists. This flexibility is permitted to allow independent designs tailored to a particular project. Minimum values are given by the lower value in a given range of values. Larger values within a given range can be used when the social, economic, and environmental impacts are not critical.

The Department follows a context sensitive solutions approach in designing projects. This approach encourages designers to take advantage of the flexibility in design standards to produce designs that

fit their natural and human environments while functioning efficiently and operating safely.

The following publications are available for a further, more detailed, discussion of design flexibility:

- Forward to the AASHTO “A Policy on Geometric Design of Highways and Streets”
- FHWA’s “Flexibility in Highway Design”
- AASHTO’s “A Guide for Achieving Flexibility in Highway Design.”
- Performance-based practical design

[https://www.fhwa.dot.gov/design/pbpd/documents/pbpd\\_fs01.pdf](https://www.fhwa.dot.gov/design/pbpd/documents/pbpd_fs01.pdf)

### **1100.2.3 New Construction and Reconstruction Project Design Criteria**

Design new construction and reconstruction projects in accordance with the criteria provided in Figure 1100-3 of this manual. For any criteria not provided in Figure 1100-3, refer to the Green Book version noted in Table 1100-1.

### **1100.2.4 3R Project Design Criteria**

The design criteria for 3R projects is provided in Table 1100-3 of this manual. Waivers or design exceptions of 3R design criteria are required only when the results or determinations of the 3R design procedures provided in section 1160 of this manual require a feature improvement and the proposed project does not include that improvement.

### **1100.2.5 HSIP Project Design Criteria**

The design criteria for Highway Safety Improvement Program (HSIP) projects are different from other projects. Because HSIP projects are intended to be cost-effective solutions to specific safety problems, project scope is limited to that which was HSIP-approved by the Chief Engineer. In general, it is not necessary to improve features that do not meet current standards unless the improvements contribute to solving the safety problem targeted by the project. (However, it is necessary to make improvements that are *legally* required, such as those covered by the Americans with Disabilities Act, on all facilities that are physically altered by an HSIP project).

In some cases, it may be appropriate to expand the scope of an HSIP project beyond that approved by the chief engineer. Submit proposed scope change to the regional traffic and safety engineer (RTSE) for consideration. If the additional work qualifies under the HSIP process, the RTSE submits the recommended changes to the state traffic & safety engineer for scope modification and HSIP funding change approvals. If the additional work does not qualify under the HSIP process, the RTSE submits the recommended scope change to the state traffic engineer for scope modification approval prior to seeking funding for the work from other sources.

### **1100.2.6 Preventive Maintenance (PM) Project Design Considerations**

Design considerations for PM projects are found in Section 1140.

## **1100.3. Design Exceptions and Design Waivers**

### **1100.3.1 General**

A design exception or waiver may be granted for an individual project element or a segment of the project where design criteria does not satisfy applicable design standards. 23 CFR 625.3(f) provides that design exceptions may be given on a project-specific basis to designs which do not conform to minimum design criteria. The Americans with Disabilities Act legally imposes design requirements that cannot be waived.

Justification for an exception or waiver may include:

- High cost of construction
- Negative environmental impacts
- Difficulty or cost of obtaining right-of-way
- Sensitivity to context or community values
- Performance-based practical design analysis

The careful application of flexibility in design standards and policies, appropriate use of design exceptions and waivers, and coordination with transportation enhancement activities can result in projects that provide safe and efficient transportation facilities and are sensitive and responsive to scenic and historical resources.

Two types of roadway design criteria are provided in Figure 1100-2: controlling design criteria and non-controlling design criteria. Use Section 1100.3.2 -

Design Exceptions - for controlling design criteria and Section 1100.3.3 Design Waivers for non-controlling design criteria.

Design exceptions and waivers are not required for Preventive Maintenance (PM) projects, except for vertical clearance.

### **1100.3.2 Design Exceptions**

Design exceptions apply only to controlling design criteria. FHWA identifies controlling design criteria as those having substantial importance to the operational and safety performance of a highway such that special attention should be paid to them in design decisions.

The 10 controlling design criteria for high-speed NHS roadways with a design speed greater than or equal to 50 mph are:

1. Design speed
2. Lane width
3. Shoulder width
4. Horizontal curve radius
5. Superelevation
6. Maximum grade
7. Stopping sight distance (SSD)
8. Cross slope
9. Vertical clearance
10. Design loading structural capacity

The two controlling design criteria for low-speed NHS roadways with a design speed less than 50 mph are:

1. Design speed
2. Design loading structural capacity

Design exceptions to these controlling criteria can, for the most part, be easily identified and defined.

However, design speed is a design control rather than a specific design element. It is used to determine the range of design values for many of the individual design elements such as stopping sight distance and horizontal curvature. Exceptions for design speeds are rare and can often be handled by exceptions for specific design elements rather than the design control (design speed).

### **Justification, Evaluation, and Approval of Design Exceptions**

When design standards for controlling design criteria are not met, a design exception is required. If no minimum or maximum design standards are provided for the specific controlling design criteria, an exception is not required.

Design exceptions need to document all of the following:

- Specific design criteria not met
- Existing roadway characteristics
- Alternatives considered
- Comparison of the safety and operational performance of the roadway
- Right-of-way
- Environmental impacts
- Cost
- Comparison of usability of all modes of transportation
- Proposed mitigation measures
- Compatibility with adjacent sections of roadway

When a design exception involves design speed, additional documentation is required:

- Length of section with reduced design speed compared to the overall length of the project
- Measures used in transitions to adjacent section with higher or lower design or operating speeds

When a design exception involves design loading structural capacity, verify that the safe load-carrying capacity (load rating) meets state legal loads and routine overweight permit loads.

Submit the design exception request, including the proposed preliminary design, cost estimates, justification, and evaluation to the regional preconstruction engineer. The regional preconstruction engineer will either approve the design exception request in writing or reject it. Furnish an informational copy of all approved design exceptions to FHWA. FHWA must concur with design exception approvals on high profile projects.



Discuss all design exceptions in the Design Study Report (DSR) and include approvals in the DSR appendix.

For further information regarding design exceptions, see FHWA publication *Mitigation Strategies for Design Exceptions, July 2007* (FHWA-SA-07-011):

[http://safety.fhwa.dot.gov/geometric/pubs/mitigationstrategies/fhwa\\_sa\\_07011.pdf](http://safety.fhwa.dot.gov/geometric/pubs/mitigationstrategies/fhwa_sa_07011.pdf)

### 1100.3.3 Design Waivers

A design waiver is a documented decision to design a highway element or a segment(s) of a highway project to design criteria that do not meet standards as established for that highway or project. The design criteria, for this definition, are all design criteria not considered controlling design criteria as previously defined in Section 1100.3.2.

Submit the design waiver request, including the proposed preliminary design, cost estimates, justification, and evaluation to the regional preconstruction engineer. The regional preconstruction engineer will either approve the design waiver request in writing or reject it.

Design waivers are not required for PM projects, except for vertical clearance.

Discuss all design waivers in the DSR and include approvals in the DSR appendix.

### 1100.4. Specific Project Criteria

The engineering manager is provided source program documents that describe the proposed design project which are used to develop the Design Designation.

#### 1100.4.1 Design Designation

The Design Designation requires written approval by the regional preconstruction engineer. The Design Designation contains the data which is the basis for establishing the design criteria. The Design Designation contains the following:

- State route number
- Route name
- Project limits
- State project number
- Federal project number
- General project description
- Project type
- Design functional classification

- Project design life
- Traffic projections
- Traffic mix
- Design vehicle(s) description
- Design vehicle loading
- Equivalent single-axle loads (ESALs)
- Level of service (urban)
- Terrain Type

An example Design Designation form is shown in Figure 1100-1.

#### Functional Classification

The design designation establishes the appropriate functional classification for design.

Chapter 1 of the Green Book provides definitions and descriptions of functional systems for rural and urban areas. The portion of Chapter 1, titled Functional Classification as a Design Type, provides guidance for establishing appropriate functional classification for design.

#### Design Life

The engineering manager establishes the project design life.

AS 19.10.160 requires use of the minimum design life listed in the following table for new construction and reconstruction projects (preventive maintenance and 3R projects are excluded) within federally recognized metropolitan planning areas:

Contract Amount <sup>1</sup>	Min. Design Life <sup>2</sup>
0 - \$5 Million	10 Years
> \$5 Million	20 Years

<sup>1</sup>The Contract Amount is the estimated construction contract amount at Environmental Document approval.

<sup>2</sup>The beginning of the design life period is the calendar year following the estimated calendar year of construction final acceptance.

For reconstruction and new construction highway projects outside recognized metropolitan planning areas, use the above table as guidance.

The design life for all projects, including 3R projects, should at least equal the expected service life of the improvements.

For PM projects, the design life equals the pavement design life as specified in Section 1140.

#### **1100.4.2 Project Design Criteria**

Project design criteria are developed from the Design Designation and the project development process. The Project design criteria are integral to the Design

Study Report and the regional preconstruction engineer must approve them. An example Project Design Criteria form is shown Figure 1100-2.

# DESIGN DESIGNATION

State Route Number: \_\_\_\_\_ Route Name: \_\_\_\_\_

Project Limits: \_\_\_\_\_

State Project Number: \_\_\_\_\_ Federal Aid Number: \_\_\_\_\_

Project Description: \_\_\_\_\_

Design Functional Classification:  Freeway     Collector, type \_\_\_\_\_     Rural Local Rd.  
 Rural Arterial     Local Recreational Rd.     Urban Local St.  
 Urban Arterial     Local Resource Recovery Rd.     Local Service Rd.  
 Other \_\_\_\_\_

Project Type:     New Construction - Reconstruction     3R  
 Preventive Maintenance (PM)     HSIP

Project Design Life (years):    5     10     20     25     30     Other \_\_\_\_\_

Traffic Projections:

	Current Year	Construction Year	Mid - Life Year	Design Year
	<input style="width: 100px; height: 20px;" type="text"/>	<input style="width: 100px; height: 20px;" type="text"/>	<input style="width: 100px; height: 20px;" type="text"/>	<input style="width: 100px; height: 20px;" type="text"/>
2-Way AADT*	<input style="width: 100px; height: 20px;" type="text"/>	<input style="width: 100px; height: 20px;" type="text"/>	<input style="width: 100px; height: 20px;" type="text"/>	<input style="width: 100px; height: 20px;" type="text"/>
2-Way DHV	<input style="width: 100px; height: 20px;" type="text"/>	<input style="width: 100px; height: 20px;" type="text"/>	<input style="width: 100px; height: 20px;" type="text"/>	<input style="width: 100px; height: 20px;" type="text"/>
Peak Hour Factor	<input style="width: 100px; height: 20px;" type="text"/>	<input style="width: 100px; height: 20px;" type="text"/>	<input style="width: 100px; height: 20px;" type="text"/>	<input style="width: 100px; height: 20px;" type="text"/>
Directional Distribution	<input style="width: 100px; height: 20px;" type="text"/>	<input style="width: 100px; height: 20px;" type="text"/>	<input style="width: 100px; height: 20px;" type="text"/>	<input style="width: 100px; height: 20px;" type="text"/>
Percent Recreational Vehicles	<input style="width: 100px; height: 20px;" type="text"/>	<input style="width: 100px; height: 20px;" type="text"/>	<input style="width: 100px; height: 20px;" type="text"/>	<input style="width: 100px; height: 20px;" type="text"/>
Percent Commercial Trucks	<input style="width: 100px; height: 20px;" type="text"/>	<input style="width: 100px; height: 20px;" type="text"/>	<input style="width: 100px; height: 20px;" type="text"/>	<input style="width: 100px; height: 20px;" type="text"/>
Compound Growth Rate	<input style="width: 100px; height: 20px;" type="text"/>	<input style="width: 100px; height: 20px;" type="text"/>	<input style="width: 100px; height: 20px;" type="text"/>	<input style="width: 100px; height: 20px;" type="text"/>
ESALs	<input style="width: 100px; height: 20px;" type="text"/>	<input style="width: 100px; height: 20px;" type="text"/>	<input style="width: 100px; height: 20px;" type="text"/>	<input style="width: 100px; height: 20px;" type="text"/>
Pedestrians (Number/Day)	<input style="width: 100px; height: 20px;" type="text"/>	<input style="width: 100px; height: 20px;" type="text"/>	<input style="width: 100px; height: 20px;" type="text"/>	<input style="width: 100px; height: 20px;" type="text"/>
Bicyclists (Number/Day)	<input style="width: 100px; height: 20px;" type="text"/>	<input style="width: 100px; height: 20px;" type="text"/>	<input style="width: 100px; height: 20px;" type="text"/>	<input style="width: 100px; height: 20px;" type="text"/>

\* Use AFPDM Traffic Data Request Form, Figure 6.1 for pavement design. Form 6.1 is available on-line at:  
[http://www.dot.state.ak.us/stwddes/dcsprecon/assets/pdf/other/traffic\\_data\\_req\\_form.pdf](http://www.dot.state.ak.us/stwddes/dcsprecon/assets/pdf/other/traffic_data_req_form.pdf)

Design Vehicle: \_\_\_\_\_

Level of Service (Urban Only): \_\_\_\_\_

Design Speed : \_\_\_\_\_

Terrain :     Level     Rolling     Mountainous

Attach intersection diagrams to this document, when appropriate

APPROVED \_\_\_\_\_ DATE \_\_\_\_\_  
Preconstruction Engineer

**Figure 1100-1  
Design Designation Form**

## DESIGN CRITERIA CHECKLIST

Project Name [redacted] Page [redacted] of [redacted]  
 State Project No. [redacted] Fed. Project No. [redacted]  
 Functional Classification: [redacted] Terrain: [redacted]  
 Present Year (&ADT): [redacted] Design Year (&ADT): [redacted]  
 DHV (%): [redacted] Directional Split (%): [redacted] Percent Trucks: [redacted]  
 Pavement Design Year: [redacted] Pavement Design ESAL: [redacted]  
 Design Turning Vehicle: [redacted] Design Accommodated Vehicle: [redacted]  
 Project Type: Choose an item.

FEDERAL 10 CONTROLLING DESIGN CRITERIA		SOURCE	STANDARD	AS DESIGNED	EXCEPTION <sup>1</sup>
1. Design Speed <sup>1</sup>			[redacted] mph	[redacted] mph	Choose an item.
2a. Travel Lane Width			[redacted] ft	[redacted] ft	Choose an item.
2b. Auxiliary Lane Width			[redacted] ft	[redacted] ft	Choose an item.
3a. Outside Shoulder Width			[redacted] ft	[redacted] ft	Choose an item.
3b. Inside Shoulder Width			[redacted] ft	[redacted] ft	Choose an item.
3c. Auxiliary Lane Shoulder Width			[redacted] ft	[redacted] ft	Choose an item.
4. Horizontal Curvature Radius			[redacted] ft	[redacted] ft	Choose an item.
5. Superelevation Rate*, e(max)			[redacted] %	[redacted] %	Choose an item.
6. Stopping Sight Distance (SSD)*			[redacted] ft	[redacted] ft	Choose an item.
7. Grade	Min.		[redacted] %	[redacted] %	Choose an item.
	Max.		[redacted] %	[redacted] %	Choose an item.
8. Cross Slope			[redacted] %	[redacted] %	Choose an item.
9. Vertical Clearance*			[redacted] ft	[redacted] ft	Choose an item.
10. Design Loading Structural Capacity <sup>1</sup>			[redacted]	[redacted]	Choose an item.

\* Attach calculations.

1. On low speed roadways (<50 mph) on the NHS only Design Speed and Design Loading Structural Capacity require a Design Exception; all other criteria become a Design Waiver. For projects off the NHS, all criteria become a Design Waiver.

**Figure 1100-2(a)**  
**Project Design Criteria**  
**For New Construction and Reconstruction Projects**

OTHER DESIGN CRITERIA	SOURCE	STANDARD	AS DESIGNED	WAIVER
Superelevation Transition*, $\Delta$		<input type="text"/> %	<input type="text"/> %	Choose an item.
Bridge Clear-Roadway Width		<input type="text"/> ft	<input type="text"/> ft	Choose an item.
Vertical Curvature, Min.	K(crest)	<input type="text"/>	<input type="text"/>	Choose an item.
	K(sag)	<input type="text"/>	<input type="text"/>	Choose an item.
Lateral Offset to Obstruction		<input type="text"/> ft	<input type="text"/> ft	Choose an item.
Surfacing Material		<input type="text"/>	<input type="text"/>	Choose an item.
Clear Zone Slope		<input type="text"/>	<input type="text"/>	Choose an item.
Clear Zone Width		<input type="text"/> ft	<input type="text"/> ft	Choose an item.
Bicycle Lane Width		<input type="text"/> ft	<input type="text"/> ft	Choose an item.
Sidewalk Width		<input type="text"/> ft	<input type="text"/> ft	Choose an item.
Intersection Sight Distance, Left Turn*		<input type="text"/> ft	<input type="text"/> ft	Choose an item.
Right Turn*		<input type="text"/> ft	<input type="text"/> ft	Choose an item.
Crossing*		<input type="text"/> ft	<input type="text"/> ft	Choose an item.
Passing Sight Distance		<input type="text"/> ft	<input type="text"/> ft	Choose an item.
Degree of Access Control		<input type="text"/>	<input type="text"/>	Choose an item.
Median Treatment		<input type="text"/>	<input type="text"/>	Choose an item.
Median Width		<input type="text"/> ft	<input type="text"/> ft	Choose an item.
Illumination		<input type="text"/>	<input type="text"/>	Choose an item.
Curb Type		<input type="text"/>	<input type="text"/>	Choose an item.

\* *Attach calculations.*

Notes:

Proposed by: \_\_\_\_\_ Date: \_\_\_\_\_  
 Designer Signature (Consultant or Staff)

Recommended by: \_\_\_\_\_ Date: \_\_\_\_\_  
 Engineering Manager Signature

Accepted by: \_\_\_\_\_ Date: \_\_\_\_\_  
 Regional Preconstruction Engineer Signature

**Figure 1100-2(a)**  
**Project Design Criteria**  
**For New Construction and Reconstruction Projects**

**PROJECT DESIGN CRITERIA - 3R PROJECTS**

Project Name:			
Project Number:			
Functional Classification:			
Design Year:		Present ADT:	
Design Year ADT:		Mid Design Period ADT:	
DHV:		Directional Split:	
Percent Trucks:		Equivalent Single Axle Loading:	
Pavement Design Year:		Design Vehicle:	
Terrain:		Number of Roadways:	
Design Speed:	<input type="checkbox"/> As-Built <input type="checkbox"/> Posted		
85th Percentile Speed:	<input type="checkbox"/> Speed Study <input type="checkbox"/> Project Drive-thru <input type="checkbox"/> Derived from existing geometrics		
Existing Lane Width			
Existing Shoulder Width			
Existing Lane + Shoulder Width			
Lane + Shldr Width for New Const.			
Exist. Superelevation Rate:			
Min. Radius for New Const.	(Evaluate Curves tighter than this)		
Min K-Value for Vert. Curves (new)	Sag:		Crest:
Stopping Sight Distance:			
Passing Sight Distance:			
Exist. Bridge No(s):			
Exist. Bridge Width(s):			
Surface Treatment:	T/W:		Shoulders:
Degree of Access Control:			
Median Treatment:			
Existing Illumination:			
Proposed Illumination:			
Existing Bicycle Accomodation:			
Proposed Bicycle Accomodation:			
Existing Pedestrian Provisions:			
Proposed Pedestrian Provision:			
Misc. Criteria:			

The shaded area represents features requiring 3R evaluation per Section 1160.

Proposed - Designer/Consultant: \_\_\_\_\_  
 Accepted - Engineering Manager: \_\_\_\_\_  
 Approved - Preconstruction Engineer: \_\_\_\_\_

Date: \_\_\_\_\_  
 Date: \_\_\_\_\_  
 Date: \_\_\_\_\_

**Figure 1100-2(b)  
 Project Design Criteria  
 For 3(R) Projects**

**Table 1100-1  
Adopted Design Standards**

<b>Acronym</b>	<b>Design Publication</b>	<b>Date</b>
<b>ABSM</b>	<i>Alaska Bridges and Structures Manual</i>	See Note 1
<b>ADA<sup>2</sup></b>	U.S. Department of Transportation ADA Standards for Transportation Facilities, and U.S. Department of Justice ADA Standards for Accessible Design	2006 2010
<b>AHDM</b>	Alaska Highway Drainage Manual	2006
<b>ASD</b>	Alaska Standard Plans Manual	See Note 3
<b>ATM</b>	Alaska Traffic Manual	See Note 4
<b>GB</b>	AASHTO A Policy on Geometric Design of Highways and Streets (Green Book)	2011
<b>GDBF</b>	AASHTO Guide for the Development of Bicycle Facilities	2012
<b>GDVLVLR</b>	AASHTO Guidelines for Design of Very Low-Volume Local Roads	2001
<b>HCM</b>	Highway Capacity Manual	2010
<b>RDG</b>	AASHTO Roadside Design Guide	2011
<b>RPRL</b>	IES Recommended Practice for Roadway Lighting (RP-8-14)	2014
<b>SSSS</b>	AASHTO Standard Specifications for Structural Supports for Highway Signs, Luminaires and Traffic Signals	See Note 5.

Note 1: Use latest edition with interims effective at time of design approval

Note 2: In most cases, the 2006 US DOT ADA Standards for Transportation Facilities applies.  
See ADA design policy below for when the 2010 US DOJ ADA Standards apply

Note 3: Use the latest edition at the time of advertising

Note 4: Use the latest edition at the time of design approval

Note 5: AASHTO, 2013, with September 2013 Errata and 2015 Interim Revisions.

ADA Design Policy:

Transportation facilities and their appurtenances constructed in public rights-of-way are required to accommodate those with disabilities. These disabilities include, but are not limited to: limited mobility, impaired vision, and impaired hearing.

Design all new public transportation facilities, including bus stops and stations, and rail stations, to meet the *Americans with Disabilities Act (ADA) Standards for Transportation Facilities* adopted by the U.S. Department of Transportation (DOT) (2006). Other types of facilities covered by the ADA are subject to the *2010 ADA Standards for Accessible Design* adopted by the U.S. Department of Justice (DOJ). 49 CFR 37, Appendix D, Subpart B, Section 37.21 states, “Both sets of rules apply; one does not override the other.

The DOT rules apply only to the entity’s transportation facilities, vehicles, or services; the DOJ rules may cover the entity’s activities more broadly. For example, if a public entity operates a transit system and a zoo, DOT’s coverage would stop at the transit system’s edge, while DOJ’s rule would cover the zoo. DOT and DOJ have coordinated their rules, and the rules have been drafted to be consistent with one another. Should, in the context of some future situation, there be an apparent inconsistency between the two rules, the DOT rules would control within the sphere of transportation services, facilities and vehicles.”

The following figure contains the initial design references for project type and design particular. The initial design reference may direct the designer to succeeding references.

Design Particular	New Construction and Reconstruction			3R
	Urban	Rural	Very Low Volume Local Roads	All
1. Design Speed*	GB	GB	N/A	HPCM Sect. 1160
2. Lane Width	GB	GB	N/A	HPCM Sect. 1160
3. Shoulder Width	GB	GB	N/A	HPCM Sect. 1160
4. Horizontal Curve Radius	GB	GB	N/A	HPCM Sect. 1160
5. Superelevation Rate	GB	GB	N/A	HPCM Sect. 1160
6. Stopping Sight Distance (SSD)	GB	GB	N/A	HPCM Sect. 1160
7. Maximum Grade	GB	GB	N/A	HPCM Sect. 1160
8. Cross Slope	GB	GB	N/A	HPCM Sect. 1160
9. Vertical Clearance	GB	GB	N/A	HPCM Sect. 1160
10. Design Loading Struct. Capacity*	GB	GB	N/A	HPCM Sect. 1160

*Note: All 10 apply to high-speed facilities. Those with an \* apply to low-speed facilities.*

**Figure 1100-3a  
Highway Design Criteria Summary  
For Roads on the NHS**



Design Particular	New Construction and Reconstruction			3R
	Urban	Rural	Very Low Volume Local Roads	All
Alleys	GB	Not Applicable	Not Applicable	HPCM Sect. 1160
Bicycle Facilities	HPCM Ch. 12	HPCM Ch. 12	HPCM Ch. 12	HPCM Sect. 1160
Bridge Width	GB	GB	GDVLVLR	HPCM Sect. 1160
Bus Turnouts	GB	GB	GB	HPCM Sect. 1160
Capacity	HPCM Ch. 10	HPCM Ch. 10	HPCM Ch. 10	HPCM Sect. 1160
Clear Zone	GB <sup>2</sup>	HPCM Sect. 1130	GDVLVLR	HPCM Sect. 1160
Climbing Lanes	GB	GB	GB	HPCM Sect. 1160
Cross Slope	HPCM Sect. 1130	HPCM Sect. 1130	GDVLVLR	HPCM Sect. 1130
Cul De Sacs	GB	GB	GB	HPCM Sect. 1160
Curbs	ASD	ASD	ASD	HPCM Sect. 1160
Design Loading Structural Capacity	ALBDS	ALBDS	ALBDS	HPCM Sect. 1160
Design Speed	GB	GB	GDVLVLR	HPCM Sect. 1160
Design Vehicle (Turning) <sup>3</sup>	GB	GB	GB	HPCM Sect. 1160
Drainage	AHDM	AHDM	AHDM	HPCM Sect. 1120.6
Driveways	HPCM Sect. 1190	HPCM Sect. 1190	HPCM Sect. 1190	HPCM Sect. 1160
Erosion Control	AHDM	AHDM	AHDM	AHDM
Escape Ramps	GB	GB	GB	HPCM Sect. 1160
Foreslopes	HPCM Sect. 1130	HPCM Sect. 1130	GDVLVLR	HPCM Sect. 1160
Freeways	GB	GB	N/A	HPCM Sect. 1160
Grade	HPCM Sect. 1120	HPCM Sect. 1120	HPCM Sect. 1120	HPCM Sect. 1160
Horizontal & Vert. Curvature	HPCM Sect. 1120	HPCM Sect. 1120	GDVLVLR	HPCM Sect. 1160
Interchanges	GB	GB	N/A	HPCM Sect. 1160
Intersection Design	GB	GB	GDVLVLR	HPCM Sect. 1160
Lane & Shoulder Width (ADT[2000])	GB	HPCM Sect. 1130	GDVLVLR	HPCM Sect. 1160
Lane & Shoulder Width (ADT[3200])	GB	GB	N/A	HPCM Sect. 1160
Lane & Shoulder Width (Interstate)	HPCM Sect. 1120.3.3	HPCM Sect. 1120.3.3	N/A	HPCM Sect. 1160
Level of Service	GB Table 2-5 <sup>5</sup>	GB Table 2-5 <sup>5</sup>	GB Table 2-5 <sup>5</sup>	HPCM Sect. 1160
Lighting	RPRL	RPRL	RPRL	HPCM Sect. 1160
Medians	HPCM Sect. 1150	HPCM Sect. 1150	HPCM - Sec. 1150	HPCM Sect. 1160
On-Street Parking	GB	GB	GB	HPCM Sect. 1160
Pavement	HPCM Sect. 1180	HPCM Sect. 1180	HPCM Sect. 1180	HPCM Sect. 1160

**Figure 1100-3b  
Highway Design Criteria Summary  
(Page 1 of 2)**

Design Particular	New Construction and Reconstruction			3R
	Urban	Rural	Very Low Volume Local Roads	All
Rail Road Grade Crossing	GB	GB	GB	HPCM Sect. 1160
Sidewalks	GB	GB	GB	HPCM Sect. 1160
Stopping Sight Distance (SSD)	HPCM Sect. 1120	HPCM Sect. 1120	GDVLVLR	HPCM Sect. 1160
Structural Supports for Signs, Luminaries and Traffic Signals	SSSS	SSSS	SSSS	SSSS
Superelevation	HPCM Sect. 1130	HPCM Sect. 1130	GDVLVLR	HPCM Sect. 1160
Super Transitions	HPCM Sect. 1130	HPCM Sect. 1130	GDVLVLR	HPCM Sect. 1160
Traffic Control Devices	ATM	ATM	ATM	HPCM Sect. 1160
Traffic Barriers	HPCM Sect. 1130	HPCM Sect. 1130	GDVLVLR	HPCM Sect. 1160
Turn Lanes	HPCM Sec. 1150	GB	GB	HPCM Sect. 1160
Turnouts	HPCM Sec. 1120.5	HPCM Sec. 1120.5	HPCM Sec. 1120.5	HPCM Sect. 1160
Vertical Clearance	HPCM Sect. 1130	HPCM Sect. 1130	HPCM Sect. 1130	HPCM Sect. 1160
Work Zone Traffic Control	HPCM Ch. 14	HPCM Ch. 14	HPCM Ch. 14	HPCM Ch. 14

- <sup>2</sup> Follow the requirements of HPCM Section 1130 for uncurbed urban sections.
- <sup>3</sup> Reference 17 AAC 25.012 and 17 AAC 25.014 for allowable legal vehicle sizes.
- <sup>5</sup> For urban and suburban arterials, see section 7.3.2 of the Green Book for further discussion on selecting the design level of service.  
For urban and suburban freeways, see section 8.2.3 of the Green Book for further discussion on selecting the design level of service.

**Figure 1100-3b  
Highway Design Criteria Summary  
(Page 2 of 2)**

This page intentionally left blank.

## **1110. (Reserved)**

---

This page intentionally left blank.

## 1120. Elements of Design

---

- 1120.1. General
- 1120.2. Interstate
- 1120.3. Bridges
- 1120.4. Retaining Wall Design
- 1120.5. Drainage
- 1120.6. Turnouts
- 1120.7. Erosion & Sediment Control Plans (ESCPs)

### 1120.1. General

The basic geometric elements of design are described in the *AASHTO A Policy on the Geometric Design of Highways and Streets 2001*. Recommendations and amendments to some of the design elements described by AASHTO may occur in the *Alaska Preconstruction Manual*. Use the design criteria set forth in the *AASHTO A Policy on the Geometric Design of Highways and Streets 2001*, as appropriate to the scope of any given project. The discussions, references and examples in this Section 1120 of the manual are preferential. Departures from Section 1120 preferential references for the design of highways and streets, other than interstate, do not require a design waiver, however, they should be supported by adequate documentation.

### 1120.2. Interstate

#### 1120.2.1 General

Interstate design criteria are essentially the same as for any limited-access, high-speed arterial. Some exceptions apply to Alaskan Rural Interstate roadways by agreement with the FHWA. This section describes these exceptions.

#### 1120.2.2 Design Speed

Interstate rural design speed for level terrain is 70 mph, for rolling terrain is 60 mph, and for mountainous terrain is 50 mph. The minimum design speed for urban interstate is 60 mph.

#### 1120.2.3 Roadway Width

Interstate criteria generally require a minimum four-lane divided facility. In Alaska, unless the DHV exceeds the capacity of a two-lane, two-way facility, a two-lane is acceptable provided the width requirements for arterials provided in the AASHTO publication *A Policy on the Geometric Design of Highways and Streets 2001* are followed and the interstate surface is no less than 36 feet from outside

shoulder to outside shoulder.

#### 1120.2.4 Access Control

Interstate roadways by definition are major arterials and continuous control of legal access is highly desirable. In urban and suburban areas, legal access to interstate roadways should only be via a public roadway; there should be no private access points. In rural areas, public roadways are desirable access points. However, private access points may be required where the route traverses major private land holdings.

### 1120.3. Bridges

#### 1120.3.1 General

Use the latest edition (with interims) of the *AASHTO Bridge Design Specifications* in the design of all bridges. Refer to 1160.1.3 for bridges on 3R projects.

#### 1120.3.2 Design Loads

The design live load for all interstate bridges shall be HS-25. HS-25 shall also be the live load for major hauling routes, for routes accessing major shipping points, and for access routes to identified resource areas.

All designs shall include 26 psf for future surfacing dead load.

#### 1120.3.3 Seismic Design

- a. **General:** All new structures must follow the requirements as stated in 1 above. All bridge retrofit projects (except 3R) must follow the latest *FHWA Seismic Retrofitting Manual for Highway Bridges*.
- b. **Seismic Sensitivity:** The state materials engineer will provide the seismic level of activity for a given site.
- c. **Seismic Resistance Standards:** Simply supported multiple span structures require the ends of the superstructure to be tied together and to the substructure. Do not use skew angles for bridges greater than 30 degrees unless approved by the chief bridge engineer, and do not use steel rocker bearings. Provide all bearings with transverse restraints, and all anchor bolts for bridge bearings with an anchor plate at the embedded end. Provide all abutments with a full-width, continuous-bearing seat, mechanically stabilized wall systems may be used to support abutments only with the prior approval of the state

foundation engineer. For abutment and retaining walls, use dowels in addition to normal shrinkage and temperature steel on the compression face to connect the stemwall to footing. Spread footings for abutments and piers must have reinforcement in the top face to resist seismic forces.

d. **Detailing Standards:** For new bridges, special detailing standards are required for the four components of the bridge system: superstructure, bearings and joints, substructure, and foundation. In addition, pay special attention to the following areas:

- **Special reinforcement for columns:** Per AASHTO, extend reinforcement the required distance into the soffit of the superstructure and into the footing.
- **Vertical column reinforcement:** Laps shall be within the centermost section of columns.
- **Footing steel layout (abutments and piers):** We require a minimum reinforcement of #8 bars at 12 inches each way, top and bottom.

#### **1120.3.4 Vertical Clearance**

Reference Table 1130-1 for vertical clearances.

#### **1120.3.5 Bridge Rail**

The standard bridge rail will be the “Oregon Two-Tube” rail with curb, with PL-2 rating. The concrete barrier or some other crash-tested rail shape may be desirable in some circumstances. Do not use railings other than the Oregon Two-Tube unless approved by the chief bridge engineer. Bridge rail must comply with NCHRP 350 test level 2 or 3.

#### **1120.3.6 Bridge Decks**

Make the minimum deck thickness 6 inches, including prestressed units. All reinforcing steel in the deck (for precast girders this would include the stirrups) shall be epoxy-coated. Minimum concrete cover on reinforcing steel in cast-in-place decks shall be 2.5 inches, with a minimum cover on prestressed units of 2.5 inches.

#### **1120.3.7 Bridge Deck Protection**

Use a full-width deck membrane on all bridge decks, overlaid with a minimum of 2 inches of asphalt.

#### **1120.3.8 Elastomeric Pads**

Elastomeric compound used in the construction of the pads shall contain only virgin natural polyisoprene (natural rubber) as the raw polymer. Do not use

Neoprene.

#### **1120.3.9 Shear Transfer on Skewed Bridges**

In a skewed bridge, the loads tend to distribute to the supports in a direction normal to the support. This causes a greater portion of the load to be concentrated at the obtuse corners of the span and less at the acute corners. On concrete girders, additional shear reinforcing is required; on steel girders, additional transverse stiffeners may be required, depending on diaphragm type and location.

## HORIZONTAL CURVE, GRADE AND SIGHT DISTANCE CRITERIA SUMMARY

Design Speed (mph)	SIGHT DISTANCE (2)		HORIZONTAL CURVES					MAXIMUM GRADES % (1)							
	MINIMUM STOPPING (feet)	MINIMUM PASSING (feet)	DESIRABLE		MINIMUM* RADIUS (feet) (4)	MAXIMUM DEGREE OF CURVE (4)	MINIMUM** LENGTH (feet) (4)	ARTERIAL		FUNCTION and TERRAIN					
			RADIUS (feet) (4)	DEGREE OF CURVE (4)				L	R	L	M	L	R	M	
20	115	710	155	36.75	115	49.25	(3)			7	10	12	8	11	16
25	155	900	235	24.25	185	30.75	(3)			7	10	11	7	11	15
30	200	1090	350	16.25	275	20.75	450			7	9	10	7	10	14
35	250	1280	550	10.25	380	15.00	525			7	9	10	7	10	13
40	305	1470	750	7.50	510	11.00	600	5	6	8	7	8	10	7	10
45	360	1625	1250	4.50	660	8.50	675	5	6	7	7	8	10	7	9
50	425	1835	1725	3.25	835	6.75	750	4	5	7	6	7	9	6	8
55	495	1985	2500	2.25	1065	5.25	825	4	5	6	6	7	9	6	7
60	570	2135	3500	1.50	1340	4.25	900	3	4	6	5	6	8	5	6
65	645	2285	5000	1.00	1660	3.25	975	3	4	5					

\* Maximum  $e \leq 6\%$

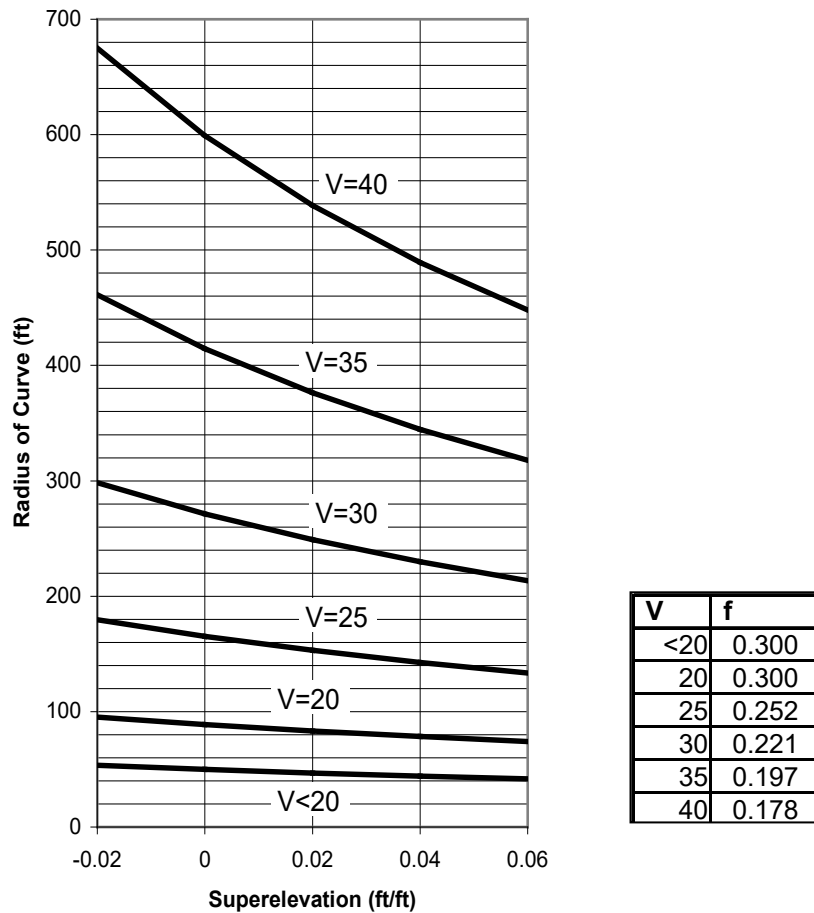
\*\* The minimum length for horizontal curves on main highways,  $L_c$  min should be about 15 times the design speed in mph. On high speed controlled-access facilities that use flat curvature, a desirable minimum length of curve for aesthetic reasons would be about double the minimum length described above, or  $L_c$  des = 30V

- (1) Short grades (500 ft long or less) and one-way downgrades may be one percent steeper. L = Level, R = Rolling, M = Mountainous. Urban arterial grades except for freeways and expressways may be increased to the maximums indicated for Collectors. Grades may be 2% steeper than shown for low-volume rural highways. The minimum grade for streets with curb and gutter is 0.3%.
- (2) Sight distances are based on a drivers height of eye of 3.5 ft, height of object for stopping of 2 ft and height of object for passing 3.5 ft.
- (3) Design speeds of 20 and 25 mph are usually restricted to local roads and separate turning roadways where other design criteria apply.
- (4) Radii and degree of curvature are rounded for design and field layout convenience and do not necessarily equate. Only one system (radius or degree of curvature) should be used on a given roadway. This does not preclude use of degree of curvature for through roadways and radii for turning roadways in the same project.
- (5) The radius and degree of curve values in this table are for higher speed roadways. Low speed streets may use values presented in Figure 1120-2. Gravel roads should use radius values shown in Figure 1120-3.

**Figure 1120-1  
Horizontal Curve, Grade, and Sight Distance Criteria Summary**



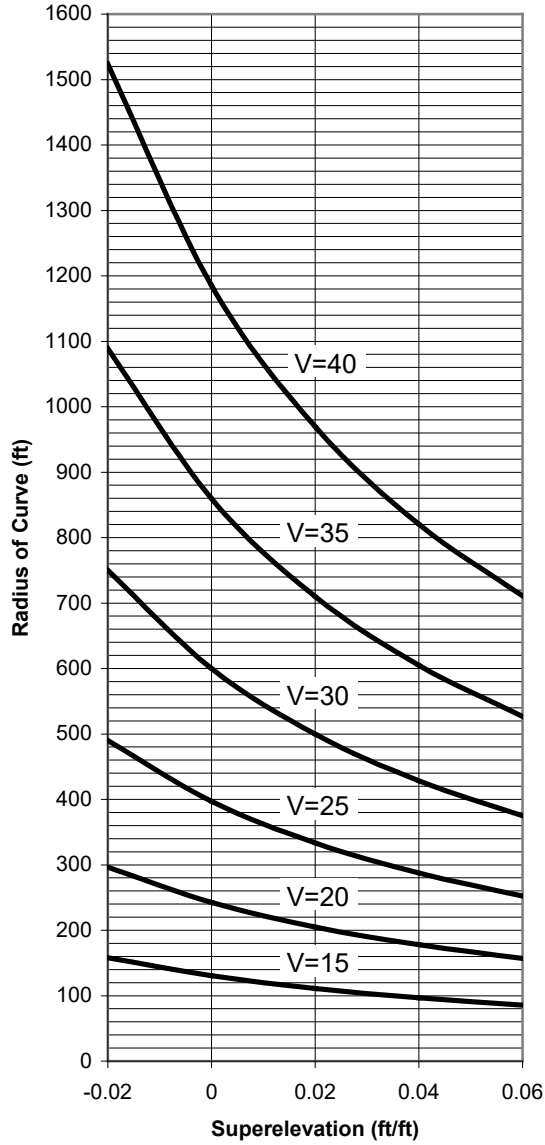
## Safe Speeds on Low Speed Paved Streets and Turning Roadways



Motorists navigating low-speed streets and turning roadways expect to encounter higher side-thrust ( $f$ ) values, hence, the higher “ $f$ ” values used in the standard formulas. These values may be used in critical locations for urban collector and local streets with design speeds less than 40 mph. See Figure 1120-1 for radii on higher speed roadways with standard superelevation rates.

**Figure 1120-2**  
**Design Speeds on Low-Speed Paved Streets and Turning Roadways**

**Safe Speeds on Low Speed  
Gravel Streets and Turning Roadways**



V	f
15	0.115
20	0.110
25	0.105
30	0.100
35	0.095
40	0.090

**Figure 1120-3  
Design Speeds on Low-Speed Gravel Streets and Turning Roadways**

## **1120.4. Retaining Wall Design**

### **1120.4.1 General**

After you receive ATP to PS&E, conduct a foundation investigation in accordance with Section 450.10. of this manual.

The geotechnical engineer conducting the foundation investigation must complete a written foundation report. The report should describe soil conditions, make foundation engineering design recommendations, and recommend workable wall systems. Submit the report to the project manager upon completion.

After completion of the foundation report, design and plan preparation can begin. All contract documents for retaining walls must contain a Department-approved generic wall system with fully detailed plans. In addition to the generic plan, alternative wall systems may be allowed.

### **1120.4.2 Retaining Wall Classification**

Earth retaining structures are divided into four classifications.

#### **State-Designed Structures**

State-designed structures are designed completely by the Department or a consultant without use of proprietary systems.

#### **Pre-Approved Proprietary Structures**

These are patented systems. Pre-approved status means that these retaining walls may be listed in the special provisions as an alternative retaining wall system based on the recommendation of the statewide Materials Section.

#### **Proprietary Structures Pending Approval**

A vendor has submitted these retaining wall system designs for approval. They may be added to the pre-approved list if they meet the statewide Materials Section requirements.

#### **Experimental Structures**

All new earth-retaining systems must undergo an evaluation before being accepted for routine use. Newly introduced designs or untried combinations of proprietary and nonproprietary designs or products are considered experimental. Construction project personnel, in coordination with the Department's research engineer, shall perform the evaluation of the experimental system.

### **1120.4.3 Federal Requirements, Proprietary Items**

For the use of proprietary walls on federal-aid projects, adhere to the Code of Federal Regulations, Title 23, Section 635.411, Material or Product Selection. It is quoted as follows:

- A. Federal funds shall not participate, directly or indirectly, in payment for any premium or royalty on any patented or proprietary material, specification, or process specifically set forth in the plans and specifications for a project, unless:
- Such patented or proprietary item is purchased or obtained through competitive bidding with equally suitable nonpatented items; or
  - The state highway agency certifies either that such patented or proprietary item is essential for synchronization with existing highway facilities, or that no equally suitable alternate exists; or
  - Such patented or proprietary item is used for research or for a distinctive type of construction on relatively short sections of road for experimental purposes
- B. When there is available for purchase:
- More than one non-patented, nonproprietary material
  - Semi-finished or finished article; or
  - A product that will fulfill the requirements for an item of work of a project

and these available materials or products are:

- Of satisfactory quality
- Equally acceptable on the basis of engineering analysis

and the anticipated prices for the related item(s) of work are estimated to be approximately the same, the PS&E for the project shall either contain or include by reference the specifications for each such material or product that is considered acceptable for incorporation in the work. If the state highway agency wishes to substitute some other acceptable material or product for the material or product designated by the successful bidder or bid as the lowest alternate, and such

substitution results in an increase in costs, there will not be federal-aid participation in any cost increases.

- C. A state highway agency may require a specific material or product, when there are other acceptable materials and products, when the division administrator determines the specific choice is in the public's interest. When the division administrator's approval is not obtained, the item will be nonparticipating unless bidding procedures establish the unit price of each acceptable alternative. In this case, federal-aid participation will be based on the lowest price established.

#### **1120.4.4 Wall Selection**

Selection of wall types depends on performance variables. Material availability and cost are important considerations for every site. Mechanically stabilized embankment walls usually require a select backfill material. These materials are not locally available in certain areas of the state. In remote sites, concrete is not normally practical, and the necessary aggregate may not be available locally. Again, with remote sites, transportation cost for construction equipment and materials is a major consideration. Weight and bulk should be minimized where practical.

Ease of construction is always a consideration. Always be aware of the equipment requirements to construct a wall. You must ascertain that the required equipment can be mobilized to the construction site and that it will have sufficient maneuvering room. Generally, mechanical stabilized embankment walls and anchored walls can be constructed with small tools and lifting equipment. For all the wall types, some earth-moving equipment is required, but with the tie-back wall it may be kept to a minimum.

Potential settlement is also a consideration. Rigid walls do not tolerate settlement well. If you predict any significant settlement, the most favorable walls are the mechanically stabilized embankments. With limited construction space, pile-driven cantilever walls or tie-back walls may be ideal. Cast-in-place concrete walls can be founded on piling to resist settlement, but this is usually a costly solution.

Service life is another consideration, and the use of metal products in corrosive environments (marine or acidic soils) requires special attention. Timber products should always be treated with a preservative for ground contact, and the number of field cuts

should be kept to a minimum. Concrete products exposed to salt should have corrosion protection systems for their steel reinforcing bars.

Surcharge loading (loads along the top of the retained embankment) may require walls with additional strength and stiffness. Most structures built on top of retained embankments are sensitive to significant settlement.

Aesthetic values of wall facings are important where visual exposure will be high, certainly in urban settings. Aesthetic judgments are subjective, and if appearance has a bearing on wall selection, it is best to have as large a consensus as possible.

#### **1120.4.5 Wall Design**

In all cases, determine the wall controlling geometry. The wall must fit the facility site. Design the structural aspects of a wall using the current *AASHTO Standard Specifications for Highway Bridges*.

The DOT&PF Bridge Section, or a consultant experienced in retaining wall design, will design all non-proprietary cast-in-place retaining walls over 4 feet in height.

#### **1120.4.6 Alternative Wall Designs (Proprietary)**

Consider alternative or proprietary wall designs where different wall systems appear to be equal in performance and approximately equal in estimated cost. Provide sufficient information in the contract plans so that the alternates can be competitively bid. The geometry for the alternative wall designs shall be identical to that of the required generic design. We recommend that you include alternative retaining wall systems in all contract plans and specifications involving earth-retaining structures. Using alternative designs, various retaining wall systems are presented in the contract bid package, from which the contractor can make a selection.

Proprietary wall systems must have the approval of the statewide Materials Section. Provide sufficient geometric controls on the contract plans so that a vendor may prepare a system structural design.

It is the responsibility of the designer to ensure that the wall can be constructed within the constraints of the site. Contact the statewide Materials Section for the most current list.

#### **1120.4.7 Contract Plans**

The contract plans must include a Department-

prepared generic design.

The contract plans should also provide the following minimum geometric and design information:

- a. Beginning and end of wall stations
- b. Elevation on top of wall at the beginning and end of wall, all profile break points, and roadway profile data at wall line
- c. Original and proposed profiles in front of and behind the retaining wall
- d. Cross sections at the retaining wall location at 50- to 100-foot intervals
- e. Horizontal wall alignment
- f. Details of wall appurtenances such as traffic barrier, coping, handrail, noise barrier, drainage outlets, location, and configuration of signs and lighting, including conduit location
- g. Right-of-way lines and construction permits
- h. Construction sequence requirements if applicable, including traffic control, access, and stage construction sequences
- i. Elevation of highest permissible level for foundation construction (the top of footings should be placed at least 2 feet below the frost line), location, depth, and extent of any unsuitable material to be removed and replaced
- j. Quantities table showing estimated square feet of wall area and quantity of appurtenances and traffic barriers
- k. Extreme high water and normal water levels at stream locations
- l. Subsurface boring logs (the materials foundation report should be provided as supplemental information to the contract bidding documents)
- m. The relative location of new or existing utilities in proximity of the retaining wall
- n. Material transitions at the end of walls

## 1120.5. Drainage

This section sets forth the design criteria for the hydraulic and hydrologic development of drainage systems for highways. When using these policies, follow the hydraulic and hydrologic design methods found in the *Alaska Highway Drainage Manual* and the *AASHTO Highway Drainage Guidelines*.

### 1120.5.1 Cross Drainage Culverts

Design culverts for the appropriate Hw/D Ratio. See Chapter 9 of the *Alaska Highway Drainage Manual* for the Hw/D Ratio for the particular application.

The minimum diameter for round cross-drainage culverts shall be 24 inches (Equivalent pipe-arch culverts shall have a minimum span-to-rise of 29 inches by 18 inches.). However, in icing problem areas, 36-inch diameter, round culvert pipes will be the minimum. We do not recommend equivalent pipe-arch culverts in icing areas.

Evaluate all culverts 48 inches in height or greater for the potential to fail during a design discharge due to hydrostatic and hydrodynamic forces, erosion, saturated soils, or plugging by debris. Any culvert that is found to have a failure potential must be restrained at the ends by half-height concrete headwalls or an equivalent, deadmen, or other form of vertical restraint.

Restrain all mitered pipes with half-height concrete headwalls or an equivalent. Deadmen or other forms of comparable vertical restraint are acceptable if the culvert invert lip is structurally reinforced.

### 1120.5.2 Storm Sewers

Inlets in sag locations require special attention from the designer and special design criteria are required to size and space them properly (See *Alaska Highway Drainage Manual*). A sag is any portion of the roadway where the profile grade changes from a negative grade to a positive grade. The depression formed is capable of ponding water that extends more than halfway into the nearest traveled lane if all the grate inlets become plugged with debris. This ponded area is generally contained by a curb, traffic barrier, retaining wall, or any other obstruction that prevents it from flowing off the traveled roadway.

A sag vertical curve that is located in a fill section would not be considered a sag in the above sense if the runoff can overtop the curb and flow down the fill slope without ponding water over more than half of

the nearest traveled lane. Width of spread criteria for gutter flow can be found in the *Alaska Highway Drainage Manual*.

Avoid placing sags on bridges. It is difficult to fit inlets among the reinforcing steel and the location of downspouts is often limited.

**Table 1120-1  
Design Flood Frequency**

Type of Structure	Design Frequency	
	Exceedance Probability	
Culverts in designated flood hazard areas*	100 years	(1%)
Culverts on primary highways	50 years	(2%)
Culverts on secondary highways with high DHVs or	50 years	(2%)
Culverts on secondary highways of less importance	10 years	(10%)
Channel changes in designated flood hazard areas	100 years	(1%)
Channel changes along primary highways and	50 years	(2%)
Channel changes along less important secondary	25 years	(4%)
Trunk storm sewers lines on primary highways	50 years	(2%)
All other trunk storm sewer lines	25 years	(4%)
Storm sewer feeder lines	10 years	(10%)
Side ditches, storm water inlets, and gutter flow	10 years	(10%)
Bridges in designated flood hazard areas*	100 years	(1%)
Bridges on all highways	50 years	(2%)
Scour at bridges, design	100 years	(1%)
Scour at bridges, check	1.7x100 years or 500 years	(0.2%)

\* Unless local ordinance requires a greater design frequency

*Note:* In addition to the exceedance probability used for design purposes, the Federal Highway Administration under Executive Order #11988 and the State of Alaska under Administrative Order #46 (AO #46) require the evaluation of a structure's ability to pass an event with an exceedance probability of 1 percent (Q100). This evaluation is required on all tidal and freshwater stream encroachments (i.e. 100-year tidal surge and/or 100-year flood). AO #46 further requires the evaluation of flood-related, erosion-prone, and mud slide (i.e. mud flow) hazard areas. In the case of erosion, this includes currents of water exceeding anticipated cyclical levels, an unusually high water level in a natural body of water accompanied by a severe storm, an unanticipated force of nature, a flash flood or an abnormal tidal surge, or some similarly unusual and unforeseeable event that results in flooding. For mud slides, this includes periods of unusually heavy or sustained rain.

Locate and size the inlets using the procedures outlined in the *Alaska Highway Drainage Manual*.

Provide Inlet Grates: Hydraulic-efficient and bicycle-resistant inlet grates on all storm sewer inlets. The *Alaska Highway Drainage Manual* lists acceptable grates.

### **1120.5.3 Filter Courses or Subsurface Drainage Matting**

All required filter cloth, geotextile filters or fabrics, geomembrane systems, geosynthetic materials, or granular material filter courses must be specifically designed for the application and be called for and/or detailed in the project plans.

### **1120.5.4 Hydraulic Site Surveys**

Coordinate site survey efforts with the state hydraulic engineer for all bridge structures (all hydraulic structures greater than 20 feet in length measured parallel to the roadway centerline, including single and multiple culvert installations), and regional hydraulic engineers for culvert installations and other drainage structures such as stormwater facilities. Site surveys for erosion and sediment control shall be as directed by the regional hydraulic engineer. Early coordination is critical. The hydraulic engineer may be required to visit the site prior to or with the survey crew. Site survey efforts from within consultant contract designs shall be under the direction of the consultant's engineer-in-responsible-charge.

Obtain survey data that will represent the typical conditions at the structure site as well as other locations where stage-discharge and related information will be necessary. The type of hydraulic analysis will govern the density of site data required. The following requirements for hydraulic site surveys are meant to supplement normal topographic survey requirements. Surveys for computerized terrain modeling will require additional site information, such as definition of slope break lines and distribution of survey points with regard to triangular networks (TIN). Cross-sections derived from a TIN by interpolation are not sufficiently accurate for hydraulic modeling purposes.

Site survey requirements for the design of bridges, culverts, and other drainage facilities shall include the following items commensurate with the significance

of environmental impact, risk, and importance of the structure:

- A. Provide a summary of the survey that includes a description of the basis of survey, monuments, local coordinate system with sketch, true north direction, and project datum elevation. Project datum must be reconciled with the as-built information of any existing structures within the project. If the project has tidal considerations, project datum shall be MLLW. Reconcile project stationing with any existing as-built stationing.
- B. Ordinary High Water Mark (OHW) shall be surveyed for all stream crossings along both banks within the right-of-way limits of the project. The ordinary high water mark (defined by 11AAC53.900[23]) forms a boundary line along the bank or shore up to which the presence and action of nontidal water are so common and usual, and so long continued in all ordinary years, as to leave a natural line impressed on the bank or shore and indicated by erosion, shelving, changes in soil characteristics, destruction of terrestrial vegetation, or other distinctive characteristics. The OHW line forms a jurisdictional boundary and is determined by a land surveyor registered in Alaska. Similarly, survey the High Tide Line tidal areas. Include time and date tags in water level measurements, and document the edge of water along both banks at the time of survey. If extreme high water marks are evident, locate and survey them at various points along the stream to help define the hydraulic grade line of the high water.
- C. For bridge sites, stream cross sections normal to flow direction that define the floodplain, banks, and channel bottom shall be surveyed at intervals upstream and downstream from the hydraulic structure. Generally, these cross sections will be spaced approximately one channel width. A minimum of four cross sections downstream of the structure and three cross sections upstream of the structure are usually required. Hydraulic modeling considerations require one cross section each at the downstream and upstream edges of the deck. If the bridge is skewed with respect to the flow, these two cross sections should be placed at the downstream and upstream corners respectively. Each cross section should be long enough to encompass the limits of the floodplain

and have surveyed points (x, y, z) at each slope breakpoint. In addition to cross sections, both edges of water and tops of banks shall be surveyed at the midpoint between each cross section or every 50 feet, whichever is less. Additional shots may be required to supplement cross section information at sharp bends in streams. For shallow streams, wading will be required. For deeper rivers, hydrographic (boat) survey will be required. Document pertinent observations with photographs.

- D. If the site involves an existing bridge, locate the structure horizontally and vertically with stations, offsets, and elevations. Bearings for tangents to the bridge shall be provided and compared to as-built information. Reconcile new surveys with as-built information, and elevation and station conversion equations supplied. Survey existing centerline profile on the structure and for a minimum of 200 feet from either end of the bridge. Normally required points to be surveyed on the bridge include Begin Bridge, End Bridge, centerline of pier(s), and the four corners of the structure. If asphalt is present, contact Bridge Design Section for preferred alternative point locations. Shots made on the bridge structure should be specific points that are thoroughly described so they are identifiable and repeatable. Survey existing embankment approaches to the bridge. A sufficient number of survey points under the structure to define embankments and stream banks in those areas are usually required.
- E. For culvert sites, cross sections normal to direction of flow that define the floodplain, banks, and channel bottom shall be surveyed at intervals upstream and downstream from the hydraulic structure. Survey cross sections at the estimated upstream and downstream embankment catch points. As a typical minimum, survey two additional cross sections upstream and downstream at intervals of approximately one stream width or 20 feet, whichever is greater. Survey the thalweg line (the line of deepest channel) at a maximum of a point every 20 feet between each cross section. Survey the inverts and station/offsets for both ends of existing culverts, and record a description of the culvert, including height, width, and condition. Document pertinent observations with a photograph (e.g. inlet, outlet, etc.).

- F. Survey for horizontal and vertical location other private and public structures that may be affected by the project and/or the hydraulic structure's performance. Document these structures with photographs.

#### **1120.5.5 Hydrologic and Hydraulic Standards**

- A. **Hydrology:** The hydrologic methods used to determine flood flow frequencies shall conform to the standards prescribed in the *Alaska Department of Transportation and Public Facilities Alaska Highway Drainage Manual*.
- B. **Hydraulic:** Hydraulic design standards shall conform to the standards prescribed in the Alaska Highway Drainage Manual, DOT&PF Standard Specifications for Highway Construction and the AASHTO Highway Drainage Guidelines.

#### **1120.5.6 Hydrologic and Hydraulic Reports**

For all bridges and all culverts 48 inches in diameter or greater, a Hydrologic and Hydraulic Report is required (The Hydrologic and Hydraulic Summary can be used as the report for culverts).

The state hydraulic engineer is responsible for the hydrologic and hydraulic design aspects of all bridge projects. Regional hydraulic engineers are responsible for all single and multiple culvert projects of spans less than 20 feet, measured parallel to centerline of roadway, and other drainage projects requiring a report. A qualified hydraulic engineer shall stamp consultant-prepared Hydrologic and Hydraulic Reports after review and approval by the appropriate DOT&PF regional or statewide hydraulic engineer. In addition, all changes or addendum should be reviewed prior to the start of construction. Stamped Hydrologic and Hydraulic Reports shall be forwarded to the design project manager for distribution and will become a permanent part of the project record.

Include in the Hydrologic and Hydraulic Report the following information, commensurate with the significance of the environmental impact, risk, or importance of the crossing:

- A. Location map and site plan
- B. Description of the project and any alternates
- C. **Hydraulic history of the site**, which should include, but is not limited to, the following:
1. **Tidal:** Tidal influence



- Mean Lower Low Water Elevation (MLLW)
  - Mean High Water Level Elevation (MHW)
  - Mean Higher High Water Elevation (MHHW)
  - Extreme High water Elevation (EHW)
2. **Nontidal:** Freshwater streams
    - Flood of record elevation
    - High water marks
    - Ordinary High Water Elevation (OHW) or Meander Line Elevation (ML) if documented
  3. Navigation:
    - a. Present
    - b. Future or potential
  4. Confluence:
    - a. Upstream
      - Distance
      - Potential changes
    - b. Downstream
      - Distance
      - Potential backwater
  5. Mining Activity:
    - a. Present
    - b. Future or potential
  6. Debris Problems:
    - a. Trees and underbrush
    - b. Bedload
    - c. Mud flow
    - d. Debris flow
    - e. Lake dumps
  7. Icing Problems:
    - a. Types of Icing Problems
      - Frazil
      - Glaciating
  - Ice debris
  - Glacier-dammed lakes (type of breakout)
  - b. Location
    - At bridge
      - o Thickness
      - o Elevation
      - o Unusual loads on existing piers
      - o Scouring of existing piers
    - Upstream
    - Downstream
  - c. Flow over ice
  - d. Flow under ice
  - e. Type of breakup
8. Geomorphology:
    - a. Straight
    - b. Meandering
    - c. Braided
    - d. Alluvial fan
    - e. Aggradation
    - f. Degradation
    - g. Potential for lateral movement
  9. **Bedload:** Bed material size
  10. **Environmental:** Environmental activities, such as fish passage considerations, that relate to the hydraulics of the stream or installation
- D. **Hydrology:** A discussion of the hydrology of the site should include, but is not limited to, the following:
1. **Drainage Shed:** Contributing drainage area at the site
    - Storage area
    - Stream slope
    - Mean elevation
    - Area of glaciers

2. **Geometry:** Limiting factors
  - Road sag elevation
  - Backwater constraints
  - Private property
  - Access requirements
3. **Frequency:** Perform a flood frequency analysis for all bridges, longitudinal encroachments or culverts 48 inches in diameter and larger (or equivalent for other shapes) as follows:
  - a. Q50: 2 percent probability
  - b. Q100: 1 percent probability
    - Or capacity of structure if less than Q100
    - If the capacity is less than Q100, address the probable damage, environmental impact, and economic costs that will result.
    - Culverts on secondary highways of less importance (See Table 1120-1, Design Flood Frequency) may be designed for a 10-year flood capacity. However, evaluate the culvert for overtopping at the 50- and 100-year flood.
  - c. Probability, or capacity of structure if less than Q200
  - d. Q500: 0.2 percent probability, or capacity of structure if less than Q500
  - e. Overtopping flood
    - Approximate exceedance probability
    - Water surface elevation
    - Location (where determined)
  - f. Other high water events as required
    - When data are sparse, or may lack the desired level of credibility, address the limitations of the analysis, probable error, or risk factor.
4. **Fish Passage:** In addition to item 3 above, evaluate proposed culverts in streams that support anadromous fish (i.e. salmon, grayling, etc.) for fish passage capabilities
  - during an event that has an exceedance probability of 50 percent with a potential of a two-day delay (Q2-2).
5. **Peak Discharge:** The design frequency (Q10, Q50, etc.) versus the peak discharge (Flood of Record) relationship for the site
  - E. **Local input:** Local knowledge of past floods at the site
  - F. **Backwater:** A backwater analysis of the existing structure (or natural channel) versus the proposed structure(s) during a high water event that has an exceedance probability equal to 1 percent (Q100)
  - G. **Scour:** For bridges, the calculated general, pier, and abutment scour associated with the proposed structure(s) and any counter-measures required for the following exceedance probabilities:
    1. Q100: 1 percent probability
    2. Q500: 0.2 percent probability, or the capacity of the structure if less than Q500
    3. Additional: Evaluate the structure for scour for lesser recurrence intervals as required, or as engineering judgment dictates. If you incorporate appropriate abutment scour protection into the design, abutment scour calculations are not required.
  - H. **Hydraulic Design:** A discussion of the hydraulic features of the design and why they are needed
    1. Alternate designs and their features
    2. A discussion of the limitations of the alternates and why they were rejected
  - I. **23 CFR:** The 23 Code of Federal Regulations (23 CFR), part 650.111, "Location Hydraulic Studies," requires the following items be addressed for all construction projects that encroach on the 100-year floodplain:
    1. Use National Flood Insurance Program (NFIP) maps or information developed by the highway agency, if NFIP maps are not available, to determine whether a highway location alternative will include an encroachment.
    2. Include in location studies an evaluation and discussion of the practicability of alternatives to any longitudinal encroachment.

3. Also include in location studies a discussion of the following items, commensurate with the significance of the risk or environmental impact, for all alternatives containing encroachments and for those actions that would support base floodplain development:

The risks associated with the implementation of the action

The impacts on natural and beneficial floodplain values

The support of probable incompatible floodplain development

The measures to minimize floodplain impacts associated with the action

The measures to restore and preserve the natural and beneficial floodplain values affected by the action

4. Include in location studies an evaluation and discussion of the practicability of alternatives to any significant encroachments or any support of incompatible floodplain development.
5. The studies required by part 650.111, 3 and 4 above shall be summarized in the environmental review documents prepared pursuant to 23 CFR, Part 771.
6. Consult local, state, and federal water resource and floodplain management agencies to determine if the proposed highway action is consistent with the existing watershed and floodplain management programs and to obtain current information on development and proposed actions in the affected watersheds.

J. **Conclusion:** A summary of the hydraulic features and how they will accomplish the desired protection

K. **Rip rap:** The size of rip rap required, the method of placement, and depth of key or length of toe

L. **Flood Hazard Area:** If the proposed project falls within a designated flood hazard area, the following is required:

1. **Additional Requirements:** A discussion on the additional requirements imposed on the

design because of the local floodplain regulations

2. **Compliance:** The proposed methods of complying with the regulations
3. **Certification:** Statement of certification as required by local ordinance

M. **Illustrations:** Include clarifying drawings, tables, charts, graphs, or pictures where appropriate.

N. **Documentation:** Include supporting or pertinent documentation in the appendices.

O. **Certification:** A registered professional engineer will stamp all hydraulic reports.

### **1120.5.7 Summary Hydraulic Report**

A Summary Hydraulic Report may be used for projects that have minor hydraulic impact or risks such as smaller bridges, projects with culverts only, or minor longitudinal encroachments. Consultant-prepared reports may use a Summary Hydraulic Report after consultation with the appropriate regional or statewide hydraulic engineer. Requirements for review, stamping, and submittal are the same as those stated in Section 1120.4.6. Projects that have major bridge crossings or are in designated flood hazard areas shall have a full hydraulic report. A Summary Hydraulic Report shall consist of the following as a minimum:

1. Introduction
2. History
3. Hydrology
4. Hydraulic Design
5. 23 CFR
6. Conclusion
7. Rip rap

### **1120.5.8 Hydrologic and Hydraulic Summary**

Include a Hydrologic and Hydraulic Summary on all plan sheets that have hydraulic encroachments as follows:

- A. The site plan sheet for all bridges
- B. The plan sheet for longitudinal encroachments. If the encroachment is depicted on more than one plan sheet, place the summary on the first sheet where the encroachment begins.

C. The plan sheet for culverts as follows:

1. All culverts 48 inches in height or greater
2. Any multiple culvert installation that has a total high water flow of 500 cubic feet per second (cfs) or greater for an exceedance probability of 2 percent (Q50)
3. All culverts smaller than 48 inches in height for which a hydraulic analysis has been performed

Include in the Hydrologic and Hydraulic Summary the following information:

A. **Drainage Area** in square miles

B. **Exceedance Probabilities:** The exceedance probabilities in percentages used to size the installation as required by Table 1120-1, Design Flood Frequency

C. **Design Discharges\*** in cubic feet per second (cfs) for the exceedance probabilities required in above section (Table 1120-1, Section D3)

D. **Design High Water Elevation\*** in feet for the exceedance probabilities required in item I above

E. **Anticipated Additional Backwater:** For highway crossings the additional backwater in feet for a high water event having an exceedance probability of 1 percent (Q100)

F. **Overtopping Flood:** For highway crossings, the discharge in cfs and water surface elevation in feet of the overtopping flood and its exceedance probability. The overtopping elevation is defined as follows:

1. Bridges: low steel (chord) or low-grade elevation
2. Culverts: Low-grade elevation
3. Longitudinal: Top of riprap or top of structure elevation

G. **Datum Elevation:** Datum and equation for Mean Sea Level (MSL) to Mean Lower Low Water (MLLW) if appropriate

H. **Design Streambed Elevation:** The elevation of the stream bed (or average stream bed) in feet, used for design purposes

I. **Scour:** The calculated Contraction (general) Scour depth and Local Scour depths at the piers and

abutments for all bridges for the following exceedance probabilities:

1. 1 percent exceedance probability (Q100)
2. 0.2 percent exceedance probability (Q500)\*
3. Capacity of bridge if less than a Q500
4. Crossings of greater importance shall be analyzed for other exceedance probabilities as required.

*\* Including regulatory flood in designated flood hazard areas (if available).*

Summary Example  
 Hydrologic and Hydraulic Summary

Drainage Area	25 square miles		
Exceedance Probability	2%	1%	*Regulatory Flood
Return Period	50-year (Q <sub>50</sub> )	100-year (Q <sub>100</sub> )	
Design Discharge	1,500 cfs	1,750 cfs	2,500 cfs
Design High Water Elevation	961.0 ft	961.9 ft	964.0 ft
Anticipated Additional Backwater = 0.2 ft			

The capacity of the structure is 2,500 cfs at elevation 964.0 feet, which has an exceedance probability equal to or less than 0.2 percent (Q<sub>500</sub>).

Datum = Mean Lower Low Water (-7.6 feet)

The following scour information shall be provided on bridge plans only:

Scour from streambed elevation 85 feet:

Return Period	100-year (Q <sub>100</sub> )	500-year (Q <sub>500</sub> )
Contraction Scour	1.0 ft	2.0 ft
Abutment Scour	9.0 ft	10.0 ft
Pier Scour	3.0 ft	4.0 ft

\* Shall be provided for the regulatory flood in designated flood hazard areas, if available.

## **1120.6. Turnouts**

### **1120.6.1 Types**

**Truck Emergency Turnout:** This is a widened shoulder area that is used at locations where frequent truck stops are anticipated or experienced. Typically these turnouts are provided at the beginning of passes to install tire chains or at the top of steep grades to check brakes.

**Slow Vehicle Turnout:** A widened shoulder area provided for slow moving vehicles to pull over without stopping to allow a queue to pass. Generally, two-lane highways with substantial recreational vehicle traffic and limited passing opportunities can benefit from these turnouts.

**Scenic Turnout:** This is a widened shoulder area or a separated turnout for the motorist to stop to view a point of interest. Anticipated stays are short and rest facilities generally are not provided.

**Rest Area:** This is a separated turnout to provide breaks for motorists. Convenience and comfort facilities may be provided.

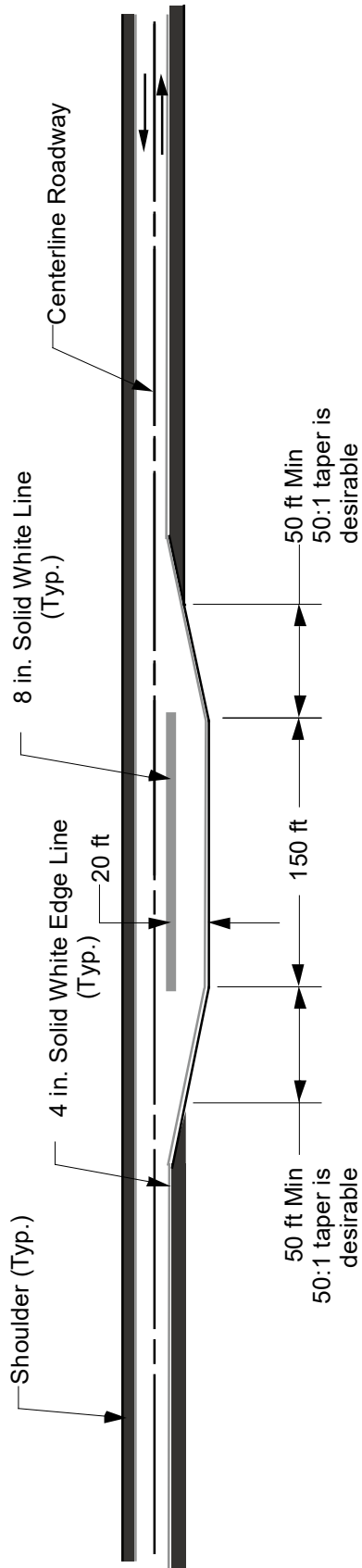
### **1120.6.2 References**

Figures 1120-4 through 1120-7 are examples of minimum recommended scenic turnouts and rest areas. Geometric, geomorphic, and environmental conditions generally dictate a custom design. References available for rest area design are provided below:

- *A Guide for Development of Rest Areas on Major Arterials and Freeways*, AASHTO, 2001, *A Guide for Transportation Landscape and Environmental Design*, AASHTO, 1991
- FHWA-IP81-1, *Safety Rest Areas: Planning, Location and Design*, FHWA, 1981
- FHPM 6-2-5-1 *Landscape and Roadside Development*
- RD-77-07 *Waste Water Treatment Systems for Safety Rest Areas*, FHWA, 1977

### **1120.6.3 Accessibility**

Scenic turnouts and rest areas and any included facilities must be accessible in accord with the Americans with Disabilities Act.

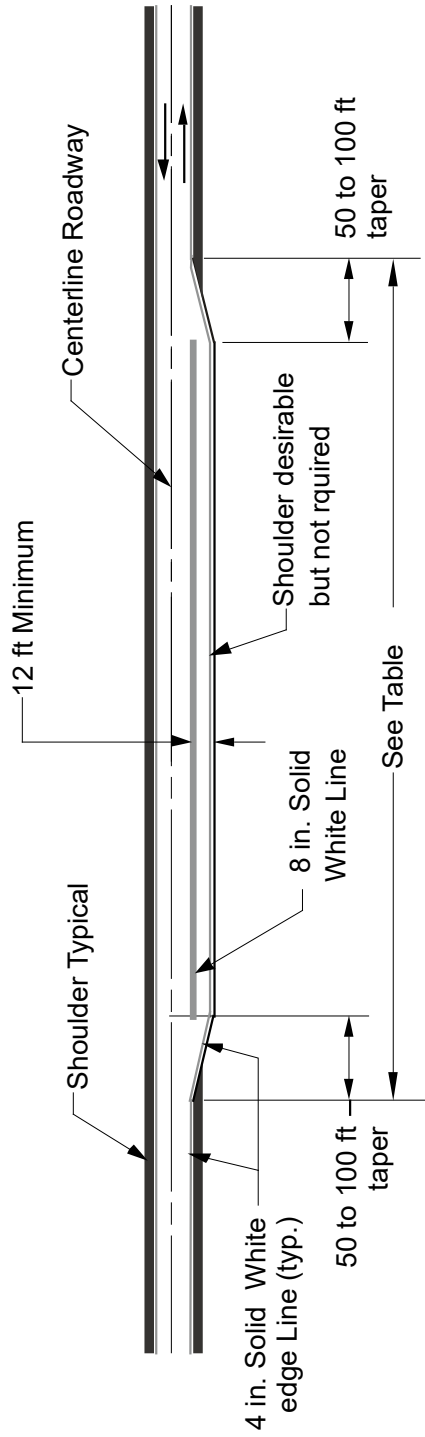


**Figure 1120-4**  
**Recommended Minimum Truck Emergency Turnout**

**NOTES:**

1. Install drainage system where required.
2. Turnout should be graded and surfaced with the same type and depth material as specified for the roadway.

**RECOMMENDED MINIMUM TRUCK EMERGENCY TURNOUT**



APPROACH SPEED (mph) OF SLOW VEHICLE	MINIMUM LENGTH (ft) *
25	200
30	200
40	300
45	350
50	450
55	550
60	600

\* Maximum Length should be 600 ft to avoid use as passing lane.

**SIGNS**

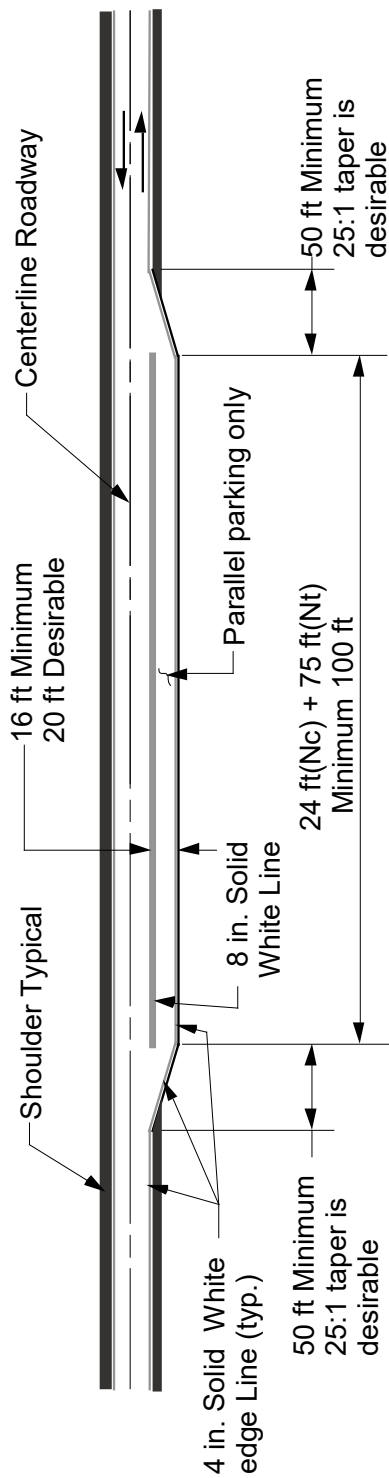
See Alaska Sign Design Manual for applicable signs.

See the Alaska Traffic Manual for sign placement.

**Figure 1120-5**  
**Slow Vehicle Turnout for Rural Two-Lane Roadways**

**SLOW VEHICLE TURNOUT FOR RURAL TWO LANE ROADWAYS**





### RECOMMENDED MINIMUM SCENIC VIEW POINT

#### **PARKING**

Car parking space = 24 ft x 8 ft  
 Truck parking space = 75 ft x 8 ft  
 $N_c$  = Car parking spaces required  
 $N_t$  = Truck parking spaces required  
 ADT = Average daily traffic with access to scenic view point  
 $D_c$  = percent of traffic composed of cars  
 $D_t$  = percent of traffic composed of trucks or large RV's  
 $P$  = Total percent on mainline traffic stopping at rest area adjusted by the ratio DSL/50  
 DSL = Design section length or distance between turnouts in miles.  
 Interstate  $P = 0.12(DSL)/50$  Primary (recreational)  $P = 0.08(DSL)/50$  Primary (rural)  $P = 0.055(DSL)/50$

$N_c = 0.09(ADT)(P)(D_c)$   
 $N_t = 0.09(ADT)(P)(D_t)$

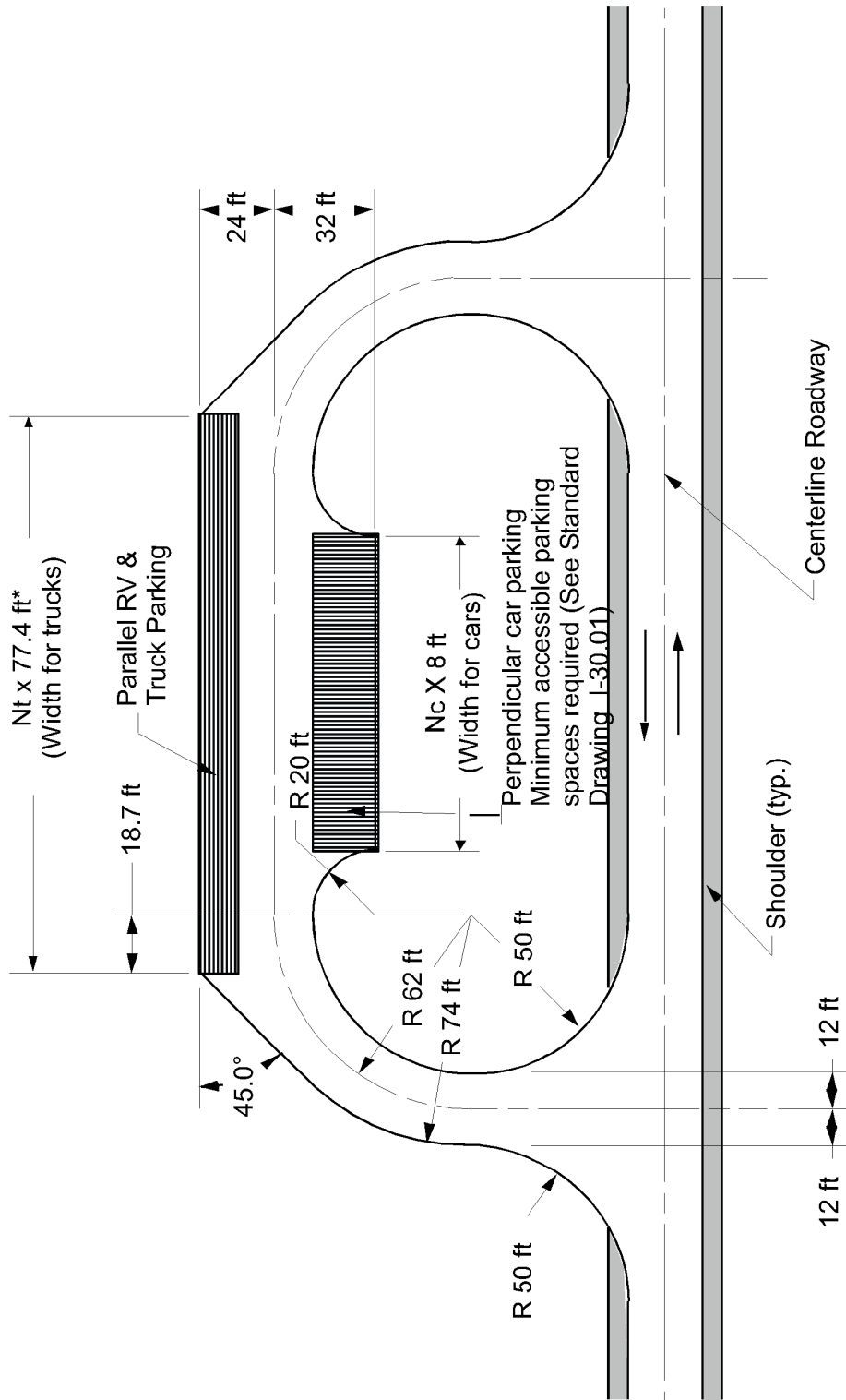
Source: Minnesota DOT Road Design Manual (rest areas)

#### **SIGNING**

Specifications: MUTCD/Alaska Supplement and the Alaska Sign Design Specifications

Ref: AASHTO Guide for Transportation Landscape and Environmental Design 1991  
 AASHTO 1990 Policy on Geometric Design of Highways and Streets  
 Transportation and Land Development by Institute of Transportation Engineers

Figure 1120-6  
 Recommended Minimum Scenic Viewpoint



\*Minimum turnout width is the larger of Width for trucks, or Width for cars + 77.4 ft  
(77.4 ft is the required layout geometry)

**RECOMMENDED MINIMUM SEPARATED TURNOUT WITH 90 DEGREE ENTRANCES**

**Figure 1120-7**  
**Recommended Minimum Separated Turnout With 90-Degree Entrances**

## 1120.7. Erosion & Sediment Control Plans (ESCPs)

### 1120.7.1 Background

Water pollution in the U.S. is regulated under the Federal Water Pollution control Act of 1972, now referred to as the Clean Water Act (CWA). In 1987, the CWA was amended to include non-point sources of pollution, such as runoff from land. Eroded sediment from construction sites that discharges into waters of the U.S. is considered pollution.

Section 402 of the CWA provides the legal basis for the Alaska Pollutant Discharge Elimination System (APDES) permit program. The Department conducts construction activities under APDES permits, primarily, the DEC Construction General Permit (CGP). The CGP requires a site specific erosion control plan for construction activities.

DEC assumed the issuance, inspection, and enforcement of all storm water permits from the EPA on November 1, 2009.

In 2010, the Department entered into a Consent Decree with the U.S. Department of Justice and the EPA. The Consent Decree requires

- Training,
- Certification,
- Additional documentation and record retention,
- Construction requirements above and beyond the CGP,

The Consent Decree has stipulated penalties for non-compliance.

The Consent Decree is found here:

<http://www.dot.state.ak.us/stwddes/desenviron/resources/stormwater.shtml>

23 CFR 650 Subpart B states that:

*“ . . . all highways funded in whole, or in part under title 23, United States Code, shall be located, designed, constructed and operated according to standards that will minimize erosion and sediment damage to the highway and adjacent properties and abate pollution of surface and ground water*

*resources.”*

Construction contractors must develop a Storm Water Pollution Prevention Plan (SWPPP) for all projects with land disturbance and must receive sufficient information and guidance in the contract documents to prepare a well-conceived, cost effective SWPPP. The purpose of an Erosion and Sediment Control Plan (ESCP) is to provide this information.

### 1120.7.2 ESCP Policy

Develop an ESCP for all projects with disturbed ground that meet either of the following conditions:

- Owned by the Department, or
- Designed (or design administered by) and constructed (or construction administered) by the Department

**Utility Relocations.** There are three types of utility relocation:

1. **Concurrent Relocation** - When the utility construction work happens at the same time as the highway construction. This is the most common type.
2. **Partial Advance Relocation** – When the utility construction work starts prior to the highway construction project. This type is uncommon.
3. **Complete Advance Relocation** – When all of the utility construction work is complete prior to award of the highway construction project. This type is rare.

All utility relocation projects require an ESCP. Types 1 and 2 generally have the ESCP developed in conjunction with the highway project’s ESCP. For type 3, a specific stand-alone ESCP must be developed for the utility relocation project.

### 1120.7.3 ESCP Development

Develop the ESCP early and in collaboration with Construction. A well prepared and complete ESCP assists in compliance with the Consent Decree.

An ESCP can consist of the following components:

- Plan sheets
- Standard specifications
- Special provisions

- Narrative (as an Appendix to the specifications or notes on the ESCP sheets)
- SWPPP template pre-filled to extent possible

Show permanent Erosion and Sediment Control (ESC) features, including final stabilization, on the roadway plan and detail drawings. These drawings are sealed and signed in accordance with 12 AAC 36.185.

Show temporary ESC features and construction phasing in the ESCP drawings, if known, and reference permanent ESC features identified elsewhere in the plans and specifications. ESCP drawings are intended to be modified by the construction contractor in preparation of his SWPPP. Do not seal ESCP drawings.

Develop the ESCP with the DOT&PF SWPPP Template format and content in mind. Designers should prepare a draft electronic copy of the project-specific SWPPP by populating the DOT&PF SWPPP Template with data, as appropriate, from the project design. The following information is recommended:

- Section 3
  - Project location, including latitude and longitude
  - Descriptions of precipitation, soils, topography, drainage patterns, approximate growing season, vegetation, and historic use of the site.
  - Size of 2 year, 24 hour storm event
- Section 4
  - Function of the project
  - Project area, disturbed area, impervious area, and runoff coefficients (before and after).
- Section 7
  - Listing of all water bodies and storm drainage systems that will receive storm runoff from the site.
  - Provide ADF&G anadromous waters catalog number for receiving waters
  - Listing of impaired water bodies with their TMDLs and relevant recommendations from the Implementation Section of the TMDL
  - Listing of impaired water bodies without TMDLs
  - Documentation of an anti-degradation

consultation that DOT&PF conducted, if the receiving water is in a state park or refuge

- Section 8: Documentation regarding endangered species
- Section 9: Describe any applicable federal, state, tribal, or local requirements
- Section 10:
  - Areas to be protected from disturbance
  - Topsoil preservation methods
  - Natural buffer areas
  - Velocity dissipation at culvert outlets
  - Run-on diversions
  - Identification of steep slopes
  - Perimeter control
  - Stabilized construction exits
  - Final stabilization
- Appendix A – Site Maps and Drawings
- Appendix D – Supporting Documentation
  - TMDLs
  - Endangered species
  - DEC non-domestic wastewater plan review
  - Environmental commitments
  - Environmental permits, including permit conditions

Provide a copy of the initial electronic DOT&PF SWPPP Template to Construction who will provide it to the construction contractor to assist in developing their SWPPP.

Use Chapter 16 of the *Alaska Highway Drainage Manual (AHD)* for:

- Fundamentals of erosion control
- Guidance and technical principals for controlling erosion
- Preparation and requirements of an ESCP

ESCP preparers are allowed to use other recognized resources for selection and application of temporary and permanent Best Management Practices (BMPs), such as:

- Alaska DOT&PF SWPPP Guide \*
- Alaska Storm Water Guide
- EPA National Menu of Stormwater BMPs
- Other state DOT or municipal stormwater/BMP manuals

Do not use Appendix B of Chapter 16 in the *AHDM* for seed mixes. Use the following revegetation resources instead:

- Alaska Department of Natural Resources (DNR) “*A Revegetation Manual for Alaska*” – 2008 updated version
- DNR’s Alaska Coastal Revegetation and Erosion Control Guide, if located in a coastal area.
- DNR’s Interior Alaska Revegetation & Erosion Control Guide, if located in the interior of the state.

The AHDM is found here:

[www.dot.state.ak.us/stwddes/desbridge/pop\\_hwydrnm\\_an.shtml](http://www.dot.state.ak.us/stwddes/desbridge/pop_hwydrnm_an.shtml)

The DNR manuals are located here:

<http://plants.alaska.gov/>

#### **1120.7.4 Payment for Erosion, Sediment, and Pollution Control**

Erosion and sediment control (ESPC) work, including SWPPP preparation and administration, typically ranges from 3-7% of the total construction cost.

Include the following pay items (refer Section 641 of the *Alaska DOT&PF Standard Specifications for Highway Construction* [SSHC]) on all projects with ESC work:

- 641(1) - Erosion, Sediment, and Pollution Control Administration.
- 641(2) or (3) - Temporary Erosion, Sediment, and Pollution Control (contingent sum or lump sum payment – use one or the other, not both).
- 641(6) - Withholding

Every project should contain the combination of 641(1), (2), and (6) or 641(1), (3), (4), and (6) pay items. Pay items 641(5) and (7) should be added at the discretion of the designer.

The project’s temporary and permanent ESC items can be paid for under

- Pay item 641(2)
- Standard SSHC pay items outside of Section 641
- Items established by special provision.

## 1130. Cross Sections

---

- 1130.1. Roadway Surfaces
- 1130.2. Roadside Geometry
- 1130.3. Sideslopes, Roadway Sections, and Drainage Channels
- 1130.4. Mailboxes
- 1130.5. Traffic Barriers
- 1130.6. Cost-Effective Analysis
- 1130.7. Pedestrian Crossings

### 1130.1. Roadway Surfaces

#### 1130.1.1 Vertical Clearance

Vertical clearances over roadways, bikeways, and pedestrian facilities should conform to Table 1130-1.

#### 1130.1.2 Cross-Slopes (See Figure 1130-1)

1. Two-lane and wider two-way undivided roadways on tangents should be crowned on the centerline dividing traffic flow. Traveled ways should slope downward from the crown to the outside edges in a plane surface at a slope not flatter than 0.02 ft/ft for paved surfaces and not flatter than 0.03 ft/ft for unpaved gravel surfaces.
2. One-way traveled ways on tangent divided roadways with two lanes may slope downward from the median or left edge of the traveled way in a single plane at a slope no flatter than 0.02 ft/ft or may be crowned as in two-lane, two-way undivided roadways. We suggest that you use a crowned section if you anticipate future widening. Crown one-way traveled ways on tangent divided roadways with three lanes or more with slopes not flatter than 0.015 ft/ft or slopes no greater than 0.02 ft/ft.
3. On all superelevated sections where the rate of cross-slope exceeds the normal shoulder rate, the superelevated rate may be carried across the entire shoulder area, or the upper shoulder may be rolled over, but the algebraic difference in slopes shall not exceed 8 percent.

#### 1130.1.3 Lane and Shoulder Widths

##### New Construction and Reconstruction

National Highway System roadway widths shall conform to the recommendations of AASHTO.

On rural roadways, off the National Highway System, with design ADT less than 2,000, you should use the

lane and shoulder widths shown in Tables 1130-2 through 1130-7. If design ADTs exceed 2,000, lane widths should be used as recommended by AASHTO.

For all urban roadways, follow AASHTO's recommendations for width of lane and shoulder, and the widths should be compatible with the level of service specified for the project.

#### Rehabilitation (3R)

For rural roadways, use the lane and shoulder widths as determined by the performance requirements of Section 1160.

Urban roadways must have lane and shoulder widths as determined for new construction.

#### Interstate

Section 1120.2. provides the minimum roadway top width for interstate.

### 1130.2. Roadside Geometry

#### 1130.2.1 General

The term "clear zone" describes a roadside border area, starting at the edge of the traveled way, available for safe use by errant vehicles. The width of the clear zone is a function of vehicle speed, ADT, and sideslope. The speed used to determine the width of the clear zone should be the design speed. The general design procedure using the clear zone concept consists of:

1. Delineating the clear zone
2. Identifying obstacles in the clear zone
3. Determining alternative treatments for obstacles within the clear zone. Except where modified by sections 1130.2, 1130.3, and 1130.4, discussion, graphs, figures, and examples from the 2002 *AASHTO Roadside Design Guide* should be the basis of roadside design. Section 1130.6 presents a cost-effective method of selecting treatment alternatives.

This chapter applies to new construction. Section 1160 applies to 3R projects.

#### 1130.2.2 Low-Speed Roadways

Where curbs exist, establish the minimum horizontal clearance as recommended by the AASHTO *A Policy*

on the *Geometric Design of Highways and Streets 2001*, for urban roadways.

### 1130.2.3 Clear Roadside Concept

#### Statement of the Clear Zone Concept

It is desirable to provide a roadside clear of hazardous objects or conditions for a distance consistent with the speed, traffic volume, and geometric conditions of the site. Provide clear zone or cost-effective alternative obstacle treatment for all new construction and reconstruction highway designs.

#### Clear Zone Width

Table 1130-2 defines clear zone width adjacent to the traveled edge of a highway. The clear zone is measured from the edge of the traveled way, and clear zone width includes the shoulder width.

Where there are through-auxiliary lanes (passing, truck climbing, and truck descending lanes) the clear zones widths are measured from the edge of the auxiliary lane travel way. In the absence of traffic studies on similar auxiliary lanes, assume when performing cost-effective analysis that the auxiliary lanes carry 50 percent of the one-way traffic at the same speed as on adjacent segments of the road.

Chapter 3 of the *AASHTO 2002 Roadside Design Guide* provides guidance and methods for determining clear zones where combinations of foreslopes and backslopes are within the roadside.

#### Special Situations Requiring Greater Width

The basic conditions assumed in the definition of the clear zone are 1) a tangent roadway section; and 2) level or near-level roadside slopes. For varying geometric conditions including slopes, curvature, and grade, errant vehicles may require lesser or greater clear recovery zones. You may also evaluate the horizontal width of the clear zone for non-tangent, non-level roadway sections using the procedures in Section 1130.6., Cost-Effective Analysis. This procedure allows adjustments to the clear zone based on varying geometric alignments and a roadside equated to a near-level clear zone.

- **Example 1130-1**

Referring to Table 1130-2, for a given sideslope, you may determine the appropriate clear zone width for a given speed. For example, a 6:1 fill sideslope for 50 mph and 5,000 ADT requires an 18-foot clear zone, while a 6:1 side slope for 60

mph and 500 ADT requires a clear zone of 16 feet.

- **Example 1130-2**

There are occasions when roadway sections may have compound slopes within the clear zone, for example, low fills with natural ground in the clear zone and ditch bottoms within the clear zone. In this case, average the slopes beginning at the edge of the traveled way. A slope steeper than 3:1 is not traversable without hazard and must be addressed as an obstacle (see 1130.3.2.). Slopes steeper than 4:1 cannot be used in averaging calculations. See Examples C through G at the end of Chapter 3 of the *AASHTO 2002 Roadside Design Guide* for example calculations.

Comply with DOT&PF Policy and Procedure 5.05.030, Beautification of the Highway Right-of-Way (P&P 5.05.030), when placing landscaping in a project right-of-way. P&P 5.05.030 is available online at: [http://www.dot.state.ak.us/admsvc/pnp/assets/chapt\\_5/05\\_05\\_030.pdf](http://www.dot.state.ak.us/admsvc/pnp/assets/chapt_5/05_05_030.pdf).

If clear zone is not provided, evaluate beautification using cost-effective analysis in Section 1130.6 to determine the appropriate treatment.

#### Treatment of Hazards and Obstacles

There are six treatments for hazards or obstacles:

1. Remove or relocate the obstacle or hazard outside of the clear zone width.
2. Redesign the obstacle or hazard so that it is traversable.
3. Provide bases that are designed to break away upon vehicle impact for engineered obstacles that must remain in the clear zone to be functional (such as a sign or illumination pole), or are too expensive to relocate (such as utilities). Breakaway fixtures meet the NCHRP 350 Test Level 3 requirements.
4. Provide clear zone by flattening slopes.
5. Shield the obstacle or hazard with traffic barriers or crash cushions.
6. Leave the obstacle or hazard in place and provide delineation that marks the hazard and increases the motorist's awareness of it.

Determine the best treatment alternative through the procedures in Section 1130.6., Cost-Effective Analysis.

### Culvert Ends in Clear Zone

Refer to Chapter 3 of the *AASHTO 2002 Roadside Design Guide* for treatment of obstacles and traversable features, including approach culvert ends and cross slope pipe ends.

Standard Drawings D-42.01, 43.01, 44.01, and 45.01 show Type C and D inlets, which have traversable designs. Verify hydraulic capacity will meet design flows before using in the project design. Other treatments are described in sections 3.4.2 and 3.4.3 of the *AASHTO 2002 Roadside Design Guide*.

### Trees in the Clear Zone

Remove all trees greater than 4 inches in diameter, or those that are likely to be greater than 4 inches in diameter at full maturity, from the clear zone unless there are unusual circumstances—for example, an eagle nesting tree, or the existence of cost-effective alternate treatments.

If clear zone is not provided, evaluate the trees using cost-effective analysis in Section 1130.6 to determine the appropriate treatment.

#### 1130.2.4 Clear Zones on Horizontal Curves

Where accident rates indicate a need for an improvement, you may use widening of the clear zone as a mitigating technique.

The following method may be used to determine widening clear zones on horizontal curves:

$$CZ_c = K_{cz} \times CZ_t$$

$$K_{cz} = \frac{L_o + W_r}{W_r}$$

$$L_o = \sqrt{R^2 + \left[ \frac{(0.9V + 15)^2}{13} \right]^2} - R$$

V = Design speed

W<sub>r</sub> = Roadside width constant

L<sub>o</sub> = Increased width factor

K<sub>cz</sub> = Curve correction multiplier

CZ<sub>c</sub> = Clear zone for curved roadways

CZ<sub>t</sub> = Clear zone for tangent roadways

R = Radius of curve

Figure 1130-2 provides values for W<sub>r</sub> and shows the method for tapering into the additional width that occurs on horizontal curves.

#### • Example 1130-3:

The radius of the roadway in Example 1130-1 is 2,292 feet.

The fill sideslope is 6:1.

The design speed is 50 mph.

$$L_o = \sqrt{(2292)^2 + \left[ \frac{(0.9 \times 50 + 15)^2}{13} \right]^2} - 2292$$

L<sub>o</sub> = 17 ft

W<sub>r</sub> = 108 ft

$$K_{cz} = \frac{17 + 108}{108} = 1.16$$

CZ<sub>t</sub> = 18 ft (From Table 1130-2 for 50 mph and 5,000 AADT)

CZ<sub>c</sub> = 1.16 x 18 ft = 21 ft

You may evaluate the horizontal width of the clear zone for non-tangent roadway sections using cost-effective analysis procedures of Section 1130.6 of this manual.

#### 1130.2.5 Clear Zones on Slopes Steeper Than 4:1

Where embankment slopes are steeper than 4:1, but equal to or flatter than 3:1, a vehicle is considered to have the ability to traverse that slope but not recover. Slopes steeper than 3:1 are not considered traversable and should be treated as obstacles.

In short, the recovery area is the required clear zone plus the horizontal distance occupied by slopes steeper than 4:1. Do not use slopes steeper than 4:1 as part of the clear zone. For additional guidance on traversable slopes, see Section 3.2 of the *AASHTO 2002 Roadside Design Guide*, and see Example C (Chapter 3) for evaluation methods. The clear runout area shown in the



*AASHTO 2002 Roadside Design Guide* should have a desirable minimum width of 10 feet.

### **1130.3. Sideslopes, Roadway Sections and Drainage Channels**

#### **1130.3.1 Transverse Sideslopes**

Refer to the *AASHTO 2002 Roadside Design Guide*, Section 3.2.3 Transverse Slopes, for guidance in designing transverse slopes within the clear zone.

#### **1130.3.2 Roadway Sections**

Roadway sections should reflect the clear roadside concept. Provide recoverable slopes unless more cost-effective alternatives are used.

One strategy to reduce costs for high fills is to use a “barn roof” section where clear zone width is provided with a recoverable slope (4:1 or flatter), then a steeper slope (non-traversable, non-recoverable, typically 1.5:1 or 2:1) is constructed to the toe of the fill. Examples D and E from Chapter 3 of the *AASHTO 2002 Roadside Design Guide* illustrate this construction.

While the barn roof section complies with desirable clear zone guidelines, there are other issues to consider. The Department has had to reevaluate these sections after construction due to public perception they are unsafe. Also, the steeper slope, even though outside of the clear zone, is an obstacle. Studies indicate that on high speed highways (greater than 45 mph) a width of 30 feet or more from the edge of the through traveled way allows about 80 percent of the vehicles leaving a roadway out of control to recover.

Another strategy for reducing costs for high embankments is the use of traffic barriers.

There is no one solution that can be applied to all high fill situations. However, cost-effective analysis procedures in 1130.6 can be used to select one of the four roadside alternatives (recoverable slopes, traversable slopes, barn roof, and barriers) on the basis of least combined accident and construction costs over the project life.

#### **1130.3.3 Ditches and Drainage Channels**

Figure 1130-3 shows recommended ditch section in rock slopes. The recommended rock excavation section uses the additional consideration of trapping falling debris by dissipating kinetic energy prior to reaching the traveled way.

The *AASHTO 2002 Roadside Design Guide* Figures 3.6 and 3.7 present traversable channel configurations and design considerations. Figure 3.6 is also applicable to rounded trapezoidal channels with bottom width less than 4 feet, and Figure 3.7 is applicable to rounded trapezoidal channels with bottom width greater than or equal to 4 feet.

Other examples of slope averaging and ditch section calculations with regard to clear zones are shown in Examples C through I of Chapter 3 in the *AASHTO 2002 Roadside Design Guide*. In some circumstances, these recommended sections will not be adaptable to certain design demands. Use the cost-effective analysis procedures in Section 1130.6 to justify other designs.

### **1130.4. Mailboxes**

Mailboxes are generally found in the clear zone and, to maintain mail service, they usually cannot be relocated outside of the clear zone. Although a mailbox and the supporting structure are obstacles, you can reduce the hazard to an acceptable level.

The vertical support in the single mailbox installation is the critical member. The support should yield on impact. The vertical support member size and its ground embedment length establish stiffness. Chapter 11 in the *AASHTO 2002 Roadside Design Guide* addresses mailboxes, location, and mailbox turnout design. Alaska Standard Drawings M-20 and M-23 comply with the AASHTO guide. Cantilever supports are preferable because the vertical member is offset farther from the traveled way and there is less conflict with snow removal.

With multiple mailbox installations, the vertical support system is stiffer because of the horizontal member that transfers load. The horizontal member itself is a problem because its level allows it to penetrate a windshield. Avoid this situation; Alaska Standard Drawings M-20 and M-23 show acceptable mountings.

Existing mailbox installations that resemble the Alaska standards from the standpoint of structural stiffness may remain in the clear zone based on the designer’s judgment. Remove other installations from the clear zone unless this is not cost-effective in accordance with Section 1130.6.

**Table 1130-1  
Vertical Clearance**

**VERTICAL CLEARANCE**

Minimum vertical clearances for the entire roadway width, should be provided according to the following table.

**RECOMMENDED VERTICAL CLEARANCE \***

OVERPASSING FACILITY	STATE HIGHWAY		LOCAL ROADS OR STREETS	RAILROAD	PEDESTRIAN STRUCTURES	SIGN BRIDGES	BOTTOM SIGNAL HOUSING	OVERHEAD UTILITIES
	INTER-CHANGE	GRADE SEPARATION						
UNDERPASSING FACILITY	16 ft - 6 in.	16 ft - 6 in. **	16 ft - 6 in. **		17 ft - 6 in.	18 ft - 6 in.	17 ft - 6 in.	20 ft - 6 in.
LOCAL ROADS OR STREETS		16 ft - 6 in. **						
STATE HIGHWAY								
RAILROAD				23 ft				27 ft - 6 in.
PEDESTRIAN FACILITY								8 ft - 6 in.

\* Clearance values shown include a 6 in. allowance for future resurfacing of the roadway.

\*\* From the Port of Anchorage to the North Slope the clearance of roadways underpassing railroads shall be 18 ft.

**Table 1130-2  
Clear Zone Distance**

## **CLEAR ZONE DISTANCE**

In feet from the edge of traveled way.

Use low side clear zone values as related to lower speed and ADT for each range.

Use high side clear zone values as related to higher speed and ADT for each range.

Design Speed	Design ADT	FILL SLOPES			CUT SLOPES ***		
		6:1 or flatter	5:1 to 4:1	3:1	3:1	4:1 to 5:1	6:1 or flatter
40 mph or less	Under 750	7-10	7-10	**	7-10	7-10	7-10
	750-1,500	10-12	12-14	**	10-12	10-12	10-12
	1,501-6,000	12-14	14-16	**	12-14	12-14	12-14
	Over 6,000	14-16	16-18	**	14-16	14-16	14-16
45 to 50 mph	Under 750	10-12	12-14	**	8-10	8-10	10-12
	750-1,500	14-16	16-20	**	10-12	12-14	14-16
	1,501-6,000	16-18	20-26	**	12-14	14-16	16-18
	Over 6,000	20-22	24-28	**	14-16	18-20	20-22
55 mph	Under 750	12-14	14-18	**	8-10	10-12	10-12
	750-1,500	16-18	20-24	**	10-12	14-16	16-18
	1,501-6,000	20-22	24-30	**	14-16	16-18	20-22
	Over 6,000	22-24	26-30 *	**	16-18	20-22	22-24
60 mph	Under 750	16-18	20-24	**	10-12	12-14	14-16
	750-1,500	20-24	26-30 *	**	12-14	16-18	20-22
	1,501-6,000	26-30	30 *	**	14-18	18-22	24-26
	Over 6,000	30 *	30 *	**	20-22	24-26	26-28
70 mph	Under 750	18-20	20-26	**	10-12	14-16	14-16
	750-1,500	24-26	28-30 *	**	12-16	18-20	20-22
	1,501-6,000	28-30 *	30 *	**	16-20	22-24	26-28
	Over 6,000	30 *	30 *	**	22-24	26-30	28-30

\* Clear zones in this table are limited to 30 feet for practicality and economy. Consider increasing the clear zone where a specific site investigation or engineering judgment indicate that an area has a higher probability of crashes and high severity conditions are present beyond 30 feet. Figure 3-1b and Table 3-1 of the *AASHTO 2002 Roadside Design Guide* provide guidance for increased clear zones.

\*\* Because recovery is less likely on the unshielded, traversable 3:1 fill slopes, fixed objects should not be present near the toe of these slopes because high-speed vehicles that encroach beyond the edge of shoulder may continue and travel beyond the toe of slope. Determination of the width of the clear runout area at the toe of slope should take into consideration right-of-way availability, environmental concerns, economic factors, safety needs, and accident histories. The width of the clear runout area should conform to the recommendations presented in Figure 3.2, example C (chapter 3), and sections 3.2.1 and 3.3.2 of the *AASHTO 2002 Roadside Design Guide*. The desirable minimum width of clear runout area is 10 feet.

\*\*\* The slopes shown are the ditch backslopes. To use these values, the foreslopes and ditch should be traversable.

See Examples C through I at the end of Chapter 3 of the *AASHTO 2002 Roadside Design Guide* for example calculations in situations where there are multiple foreslope and backslope combinations.

**Table 1130-3**  
**Off the National Highway System**  
**Rural Local Roadway**

**Lane and Shoulder Widths for New Construction and Reconstruction**

(For Rehabilitation Projects, see 3R Standards, Section 1160 and for ADTs greater than 2,000, reference the AASHTO *A Policy on the Geometric Design of Highways and Streets 2001*)

Lane width presents distance from centerline marking lines to the shoulder marking line.

<b>Local Roads</b>									
<b>Design Year ADT 0-2000 vpd</b>									
<b>≤10% Trucks – (Reference NCHRP Report 362 Table 29(a))</b>									
Design Year Traffic Volumes (ADT) in Vehicles per Day									
Design Speed (mph)	0-400	401-600		601-750		751-1500		1501-2000	
		Lane	Shoulder	Lane	Shoulder	Lane	Shoulder	Lane	Shoulder
LEVEL TERRAIN									
30	Use AASHTO GDVLVLR -	10	5	10	5	10	5	10	6
40		10	5	10	5	10	5	10	6
50*		11	4	11	4	11	4	11	6
ROLLING TERRAIN									
30	Use AASHTO GDVLVLR	10	5	10	5	10	5	10	6
40*		10	5	10	5	10	5	10	6
50		11	4	11	4	11	4	11	6
MOUNTAINOUS TERRAIN									
20	Use AASHTO GDVLVLR	9	2	10	5	10	5	10	6
30*		9	2	10	5	10	5	10	6
40		10	5	10	5	10	5	10	6

\*Recommend Design Speed for Terrain, AASHTO GB 2001 Exhibit 5-1

**Table 1130-4**  
**Off the National Highway System**  
**Rural Local Roadway**

**Lane and Shoulder Widths for New Construction and Reconstruction**

(For Rehabilitation Projects, see 3R Standards, Section 1160 and for ADTs greater than 2,000, reference the AASHTO *A Policy on the Geometric Design of Highways and Streets 2001*)

Lane width presents distance from centerline marking lines to the shoulder marking line.

<b>Local Roads</b>									
<b>Design Year ADT 0-2000 vpd</b>									
<b>&gt;10% Trucks – (Reference NCHRP Report 362 Table 29(b))</b>									
Design Year Traffic Volumes (ADT) in Vehicles per Day									
Design Speed (mph)	0-400	401-600		604-750		751-1500		1501-2000	
		Lane	Shoulder	Lane	Shoulder	Lane	Shoulder	Lane	Shoulder
<b>LEVEL TERRAIN</b>									
30	Use AASHTO GDVLVLR	10	5	10	5	10	5	10	6
40		10	5	10	5	10	5	10	6
50*		11	4	11	4	11	4	11	6
<b>ROLLING TERRAIN</b>									
30	Use AASHTO GDVLVLR	10	5	10	5	10	5	10	6
40*		10	5	10	5	10	5	10	6
50		11	4	11	4	11	4	11	6
<b>MOUNTAINOUS TERRAIN</b>									
20	Use AASHTO GDVLVLR	9	2	10	5	10	5	10	6
30*		9	2	10	5	10	5	10	6
40		10	5	10	5	10	5	10	6

\*Recommend Design Speed for Terrain, AASHTO GB 2001 Exhibit 5-1

**Table 1130-5  
Off the National Highway System  
Rural Collector Roadway**

**Lane and Shoulder Widths for New Construction and Reconstruction**

(For Rehabilitation Projects, see 3R Standards, Section 1160 and for ADTs greater than 2,000, reference the AASHTO *A Policy on the Geometric Design of Highways and Streets 2001*)

Lane width presents distance from centerline marking lines to the shoulder marking line.

Collector Roads									
Design Year ADT 0-2000 vpd									
≤10% Trucks – (Reference NCHRP Report 362 Table 29(c))									
Design Year Traffic Volumes (ADT) in Vehicles per Day									
Design Speed (mph)	0-400	401-600		601-750		751-1500		1501-2000	
		Lane	Shoulder	Lane	Shoulder	Lane	Shoulder	Lane	Shoulder
<b>LEVEL TERRAIN</b>									
40	Use AASHTO GDVLVLR	10	5	10	5	10	5	10	6
50*		11	4	11	4	11	4	11	6
60		11	4	11	4	11	4	11	6
<b>ROLLING TERRAIN</b>									
30	Use AASHTO GDVLVLR	10	5	10	5	10	5	10	6
40*		10	5	10	5	10	5	10	6
50		11	4	11	4	11	4	11	6
60		11	4	11	4	11	4	11	6
<b>MOUNTAINOUS TERRAIN</b>									
20	Use AASHTO GDVLVLR	9	2	10	5	10	5	10	6
30*		9	2	10	5	10	5	10	6
40		10	5	10	5	10	5	10	6
50		11	4	11	4	11	4	11	6

\*Recommend Design Speed for Terrain, AASHTO GB 2001 Exhibit 6-1

**Table 1130-6  
Off the National Highway System  
Rural Collector Roadway**

**Lane and Shoulder Widths for New Construction and Reconstruction**

(For Rehabilitation Projects, see 3R Standards, Section 1160 and for ADTs greater than 2,000, reference the AASHTO *A Policy on the Geometric Design of Highways and Streets 2001*)

Lane width presents distance from centerline marking lines to the shoulder marking line.

Collector Roads									
Design Year ADT 0-2000 vpd									
>10% Trucks – (Reference NCHRP Report 362 Table 29(d))									
Design Year Traffic Volumes (ADT) in Vehicles per Day									
Design Speed (mph)	0-400	401-600		601-750		751-1500		1501-2000	
		Lane	Shoulder	Lane	Shoulder	Lane	Shoulder	Lane	Shoulder
<b>LEVEL TERRAIN</b>									
40	Use AASHTO GDVLVLR	10	5	10	5	10	5	10	6
50*		11	4	11	4	11	4	11	6
60		11	4	11	4	11	4	11	6
<b>ROLLING TERRAIN</b>									
30	Use AASHTO GDVLVLR	10	5	10	5	10	5	10	6
40*		10	5	10	5	10	5	10	6
50		11	4	11	4	11	4	11	6
60		11	4	11	4	11	4	11	6
<b>MOUNTAINOUS TERRAIN</b>									
20	Use AASHTO GDVLVLR	10	5	10	5	10	5	10	6
30*		10	5	10	5	10	5	10	6
40		10	5	10	5	10	5	10	6
50		11	4	11	4	11	4	11	6

\*Recommend Design Speed for Terrain, AASHTO GB 2001 Exhibit 6-1

**Table 1130-7  
Off the National Highway System**

**Lane and Shoulder Widths for New Construction and Reconstruction**

(For Rehabilitation Projects, see 3R Standards, Section 1160 and for ADTs greater than 2,000, reference the AASHTO *A Policy on the Geometric Design of Highways and Streets 2001*)

Lane width presents distance from centerline marking lines to the shoulder marking line.

Arterial Roads												
Design Year ADT 0-2000 vpd												
≤10% Trucks – (Reference NCHRP Report 362 Table 29(e))												
Design Year Traffic Volumes (ADT) in Vehicles per Day												
Design Speed (mph)	0-250		251-400		401-600		601-750		751-1500		1501-2000	
	Lane	Shoulder	Lane	Shoulder	Lane	Shoulder	Lane	Shoulder	Lane	Shoulder	Lane	Shoulder
<b>LEVEL TERRAIN</b>												
40	9	3	9	3	10	5	10	5	10	7	10	7
50	11	2	11	2	11	4	11	4	11	6	11	6
60*	11	2	11	2	11	4	11	4	12	6	12	8
70*	12	2	12	2	12	4	12	4	12	6	12	8
<b>ROLLING TERRAIN</b>												
40	9	3	9	3	10	4	11	4	11	6	11	8
50*	10	3	10	3	11 or 10 <sup>a</sup>	4 or 5 <sup>a</sup>	11 or 10 <sup>a</sup>	4 or 5 <sup>a</sup>	11	6	11	8
60*	11	2	11	2	11	4	11	4	11	4	11	8
<b>MOUNTAINOUS TERRAIN</b>												
20	9	3	9	3	10	5	10	5	10	5	10	6
30	10	2	10	2	10	5	10	5	10	5	10	6
40*	10	3	10	3	11	2	11	2	11	6	11	6
50*	10	3	10	3	11	2	11	2	11	6	11	6

\*Recommend Design Speed Range for Terrain, AASHTO GB 2001 Discussion page 448

<sup>a</sup>10-foot lane, 5-foot shoulder if shoulder is not paved. Otherwise use 11-foot lane 4-foot shoulder.



**Table 1130-8**  
**Off the National Highway System**  
**Rural Arterial Roadway**

**Lane and Shoulder Widths for New Construction and Reconstruction**

(For Rehabilitation Projects, see 3R Standards, Section 1160 and for ADTs greater than 2,000, reference the AASHTO *A Policy on the Geometric Design of Highways and Streets 2001*)

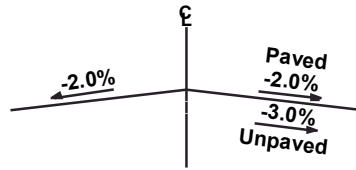
Lane width presents distance from centerline marking lines to the shoulder marking line.

<b>Arterial Roads</b>												
<b>Design Year ADT 0-2000 vpd</b>												
<b>&gt;10% Trucks – (Reference NCHRP Report 362 Table 29(f))</b>												
Design Year Traffic Volumes (ADT) in Vehicles per Day												
Design Speed (mph)	0-250		251-400		401-600		601-750		751-1500		1501-2000	
	Lane	Shoulder	Lane	Shoulder	Lane	Shoulder	Lane	Shoulder	Lane	Shoulder	Lane	Shoulder
<b>LEVEL TERRAIN</b>												
40	10	3	10	3	10	5	10	5	10	7	10	7
50	10	3	10	3	10	5	10	5	10	7	10	7
60*	11	2	11	2	11	4	11	4	11	4	11	8
70*	12	2	12	2	12	4	12	4	12	4	12	8
<b>ROLLING TERRAIN</b>												
40	10	3	11	2	11	4	11	4	11	4	11	8
50*	10	3	11	2	11	4	11	4	11	4	11	8
60*	10	3	11	2	11	4	11	4	11	4	12	8
<b>MOUNTAINOUS TERRAIN</b>												
20	10	3	10	3	10	5	10	5	10	5	10	6
30	10	3	10	3	10	5	10	5	10	5	10	6
40*	10	3	10	3	11	2	11	2	11	6	12	6
50*	10	3	11	2	11	2	11	2	11	6	12	6

\*Recommend Design Speed Range for Terrain, AASHTO GB 2001 Discussion page 448

# RECOMMENDED CROSS SLOPES

## TWO-LANE 2-WAY



## DIVIDED HIGHWAYS

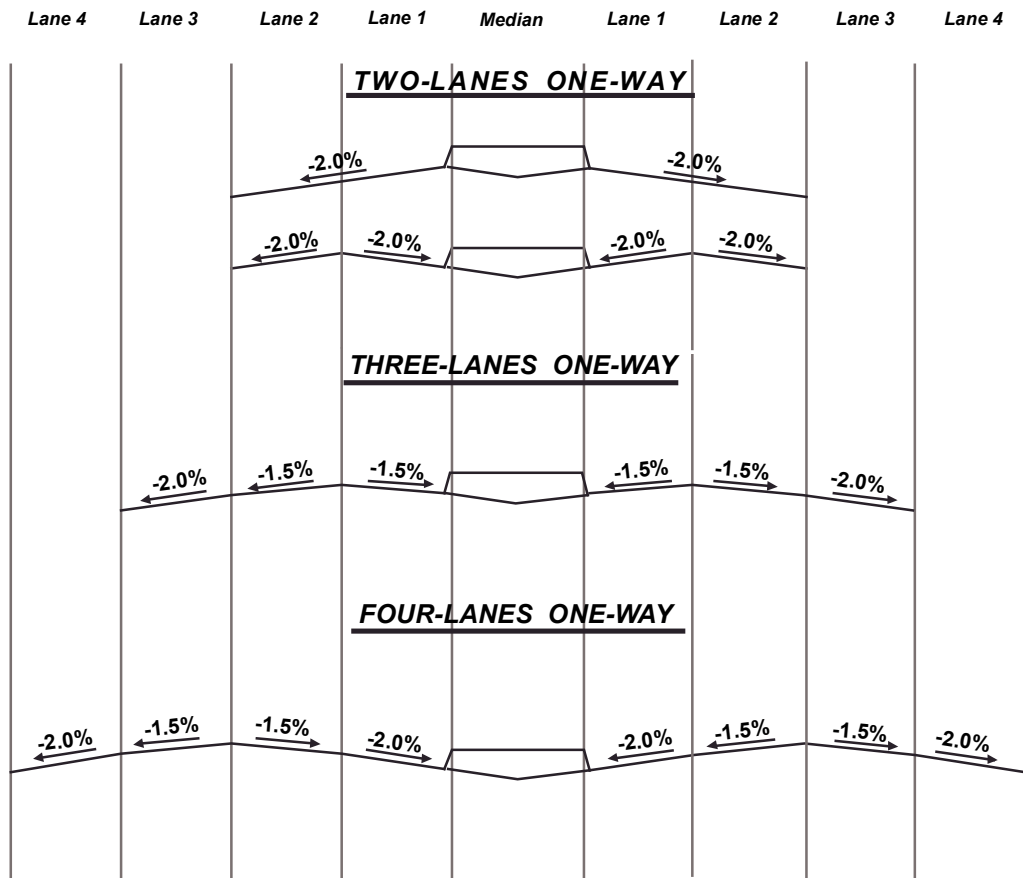
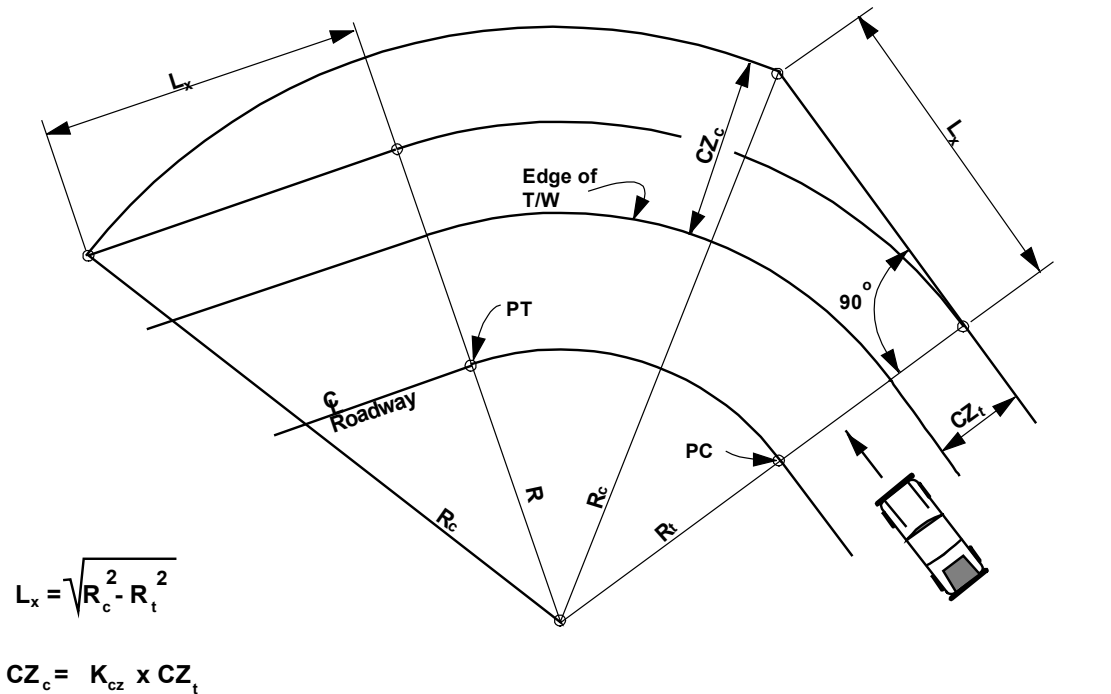


Figure 1130-1  
Recommended Cross Slopes

# HORIZONTAL CURVE **CLEAR ZONE** WIDENING OPTION FOR ACCIDENT MITIGATION



CURVE CORRECTION FACTOR ( $K_{cz}$ )							
Degree of Curve	DESIGN SPEED (mph)						
	40	45	50	55	60	65	70
2.0	1.08	1.10	1.12	1.15	1.19	1.22	1.27
2.5	1.10	1.12	1.15	1.19	1.23	1.28	1.33
3.0	1.11	1.15	1.18	1.23	1.28	1.33	1.40
3.5	1.13	1.17	1.22	1.26	1.32	1.39	1.46
4.0	1.15	1.19	1.25	1.30	1.37	1.44	
4.5	1.17	1.22	1.28	1.34	1.41	1.49	
5.0	1.19	1.24	1.31	1.37	1.46		
6.0	1.23	1.29	1.36	1.45	1.54		
7.0	1.26	1.34	1.42	1.52			
8.0	1.30	1.38	1.48				
9.0	1.34	1.43	1.53				
10.0	1.37	1.47					
15.0	1.54						

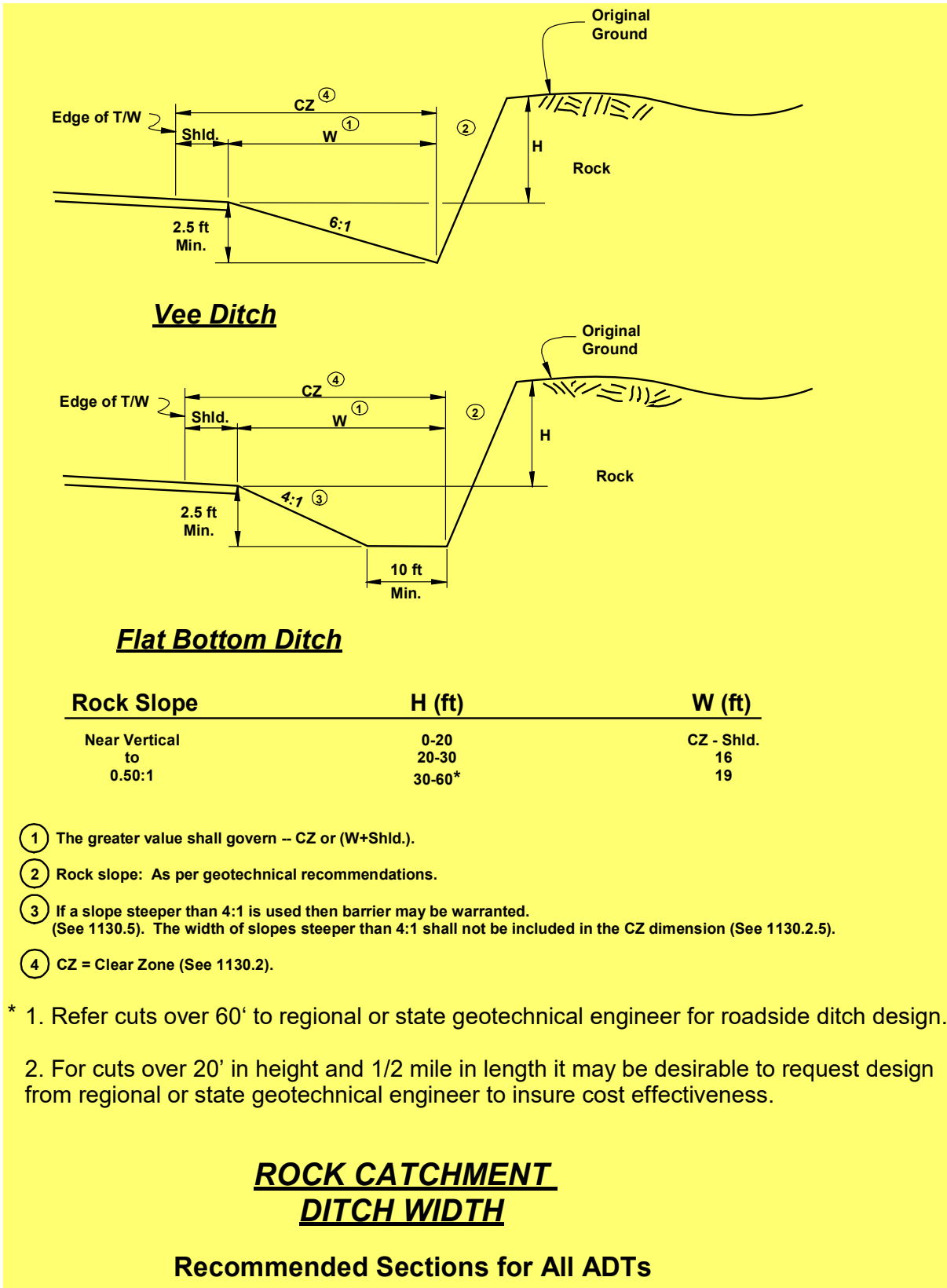
- V = Design Speed (mph)
- $W_r$  = See Table
- $K_{cz}$  = Curve Correction Factor
- $CZ_t$  = Clear Zone Distance (ft) Tangent Roadway (See Figure)
- $CZ_c$  = Clear Zone Distance (ft) Curved Roadway
- $L_o$  = Increased Width Factor
- R = Radius of Curve (ft)
- $R_t$  = Distance Radius Point to Normal Clear Zone at Curve PC
- $R_c = R_t + (CZ_c - CZ_t)$

V (mph)	$W_r$ (ft)
40	91
45	100
50	108
55	117
60	125
65	134
70	142

$$K_{cz} = \frac{L_o + W_r}{W_r}$$

$$L_o = \sqrt{R^2 + \left[ \frac{(0.9V + 15)^2}{13} \right]^2} - R$$

**Figure 1130-2**  
Horizontal Curve Clear Zone Widening Option for Accident Mitigation



**Figure 1130-3  
Rock Excavation**

## 1130.5. Traffic Barriers

### 1130.5.1 Introduction

There are two types of protective barriers commonly used on Alaska roadways: longitudinal barriers and end terminals. These serve as less severe obstacles that redirect traffic from impacting more severe hazards. Strong post w-beam guardrail is the most common longitudinal barrier, though concrete barrier, weak post box-beam, and other types of solutions are available to meet site-specific needs.

Common end terminals use posts similar to longitudinal guardrail, with specially designed systems for gating at the end and redirecting traffic along the face, while still anchoring the longitudinal barrier. In gores and medians where gating is not desirable, crash cushions may be used to bring vehicles to a stop.

Because no policy can address every real-world condition, temper these guidelines with engineering judgment. See Figure 1130-9 for guidance in evaluating when barrier use is appropriate. In general, if eliminating the hazard and barrier installation are equally cost-effective, eliminate the hazard.

### 1130.5.2 Guardrails

#### General

Barriers shall comply with NCHRP 350 test level 3, but may be increased to higher test levels as discussed in *AASHTO 2002 Roadside Design Guide* Section 5.3.

#### Guardrail Warrants for Embankments

The primary highway factors contributing to embankment accident severity are the height and slope of the embankment. The embankment height comprises the height of a fill, a natural hillside, or a combination of both. An “embankment” can also be a cut if the subject road exists at the top of that cut.

A cost-effective analysis is necessary to determine if guardrail is warranted (see Section 1130.6.). Where cost-effective, the flattening of warranting slopes is preferable to guardrail installation.

#### Guardrail Warrants for Roadside Obstacles

Roadside obstacles may be classified as non-traversable or fixed objects. Guardrail is warranted for roadside obstacles when shown to be cost-effective (see Section 1130.6.).

## Longitudinal Non-Traversable Hazards

Examples of longitudinal non-traversable hazards that may warrant guardrail are:

- Rough rock cuts
- Permanent bodies of water over 3’ deep
- Drop-offs with slopes steeper than 3:1

Because of the extended length of the hazard along the roadway, the probability of an errant vehicle striking the non-traversable hazard is greater than that of a vehicle hitting a fixed object. Barrier need for rough rock cuts is a matter of judgment.

## Fixed Objects

Examples of fixed objects that may warrant guardrail are:

- Bridge piers and abutments
- Retaining walls
- Fixed sign bridge supports
- Trees
- Approach roadway embankment

For clear zone widths, see Table 1130-2. Clear zones on horizontal curves may be adjusted as shown in Figure 1130-2 if widening is cost-effective.

## Length of Need

Length of need is equal to the length of guardrail needed for the hazard plus a length in advance to prevent vehicle penetration behind the rail into the hazard. The hazard may be a “point” hazard such as a tree, or a hazardous area such as a roadway section with severe side slopes.

Where slopes back of the graded shoulder are flat enough (see Guardrail Position Requirements: Guardrail Beyond Shoulder Edge), locate the guardrail as far away from the graded shoulder as possible to minimize this length of need, but with adequate clearance for guardrail deflection.

In the more common instances, where slopes are steeper, the guardrail will run along the shoulder. The barrier may be flared away from the traveled way. Where terrain allows, the barrier end may be buried in the backslope as a way to minimize the length of need. The flare is a method to transition the barrier to a hazard, minimizing driver reaction. The flare also

allows for a shorter barrier installation while locating the terminal end farther from the traveled way. Table 1130-10 shows recommended flare rates (b/a).

The recommended flare rates are related to the location of the barrier with respect to the Shy Line Offset. The Shy Line Offset is defined as the distance from the edge of the traveled way, beyond which a roadside object will not be perceived as hazardous and result in a motorist reducing speed or changing vehicle positions on the roadway. Table 1130-9 provides Shy Line Offsets to be used in the flare rate determination.

For additional information on calculating the length of need, as shown in Example 1130-5, refer to the *AASHTO 2002 Roadside Design Guide*. The Department has not developed any methods for calculation of length of need other than the one illustrated in Example 1130-5. The assumption of a specific encroachment angle to determine a length of barrier, as mentioned in the 2002 *AASHTO Roadside Design Guide*, is not an approved method in Alaska.

• **Example 1130-4:**

Refer to Figure 1130-4a and Figure 1130-4b.

Definitions:

$L_R$ : The theoretical distance needed for a vehicle that has left the roadway to come to a stop

$L_H$ : The distance from the edge of the traveled way to the far side of the hazard that falls within the clear zone

$L_C$ : The distance from the edge of the traveled way to the clear zone line

$L_1$ : The length of barrier upstream of the obstacle that is parallel to the traveled way

$L_2$ : The distance from the edge of the traveled way to the face of the barrier at the obstacle

$L_3$ : The distance from the edge of the traveled way to the near face of the obstacle

$P$ : The parabolic offset, obtained from Figure 1130-4a.

Given:

- G-4W barrier
- Obstacle 15 feet deep by 10 feet long

- ADT = 1,800
- Design Speed: 55 mph
- Shoulder: 6 feet
- Near face of obstacle 10 feet from edge of traveled way

Using the design speed and traffic volume, determine the desirable Run Out Length ( $L_R$ ) from Table 1130-11. With a volume of 1,800 vehicles per day and design speed of 55 mph.,  $L_R$  is 315 feet.

The Shy Line Offset is 7.2 feet from Table 1130-9.

Position barrier 3 feet in front of the obstacle (measured face of obstacle to face of barrier).

Therefore  $L_2 = 7$  ft,  $L_3 = 10$  ft, &  $L_H = 25$  ft

$L_1 = 6.25$  ft (See Standard Drawings for spacing from obstacle).

$L_2 <$  Shy Line Offset. Therefore, from Table 1130-10, the flare rate  $b/a = 1:24$ .

Solve equation for a tangent and flared guardrail with a parabolic end terminal (assume SRT 350). Equation is:

$$x = \frac{L_H - L_2 + \frac{b}{a}L_1 - \frac{a \times P}{\sqrt{a^2 + b^2}}}{\frac{L_H}{L_R} + \frac{b}{a}}$$

And:

$$x = \frac{25 - 7.5 + \frac{1}{24} \times 6.25 - \frac{24 \times 1.79}{\sqrt{24^2 + 1^2}}}{\frac{25}{315} + \frac{1}{24}}$$

$x = 131.97$  feet, or 132 feet

**Guardrail Position Requirements**

*Guardrail Beyond Shoulder Edge*

At fixed objects, it is best to locate guardrail as far away from the shoulder as practical to maximize recovery area and minimize the length of need. Adequate deflection space must be allowed between the guardrail and the object (See the *AASHTO 2002*

*Roadside Design Guide* Appendix B for deflection data.) If the deflection space cannot be attained, use a stiffer rail section. For installations where the guardrail is located within 20 feet of the shoulder edge or hinge point, negative slopes in front of the guardrail shall be 10:1 or flatter, and the algebraic difference between the shoulder slope and the slope in front of the guardrail should not be greater than 0.10 in order to ensure the proper impact height. Guardrail placed more than 20 feet from the hinge point should have at least 12 feet of 6:1 or flatter slope in front of the rail, and the hinge point need not be rounded.

#### *Guardrail Back of Curb*

Curbs in front of guardrail should be avoided where possible. Where no alternative is available, refer to the *AASHTO 2002 Roadside Design Guide* Sections 3.4.1 and 5.6.2.1 for additional guidance on the design of traffic barriers near curbs.

#### *Bridge Approaches*

Guardrail at bridge approaches shall have appropriate transitions to alleviate pocketing for impacts just in front of the abutment or bridge rail ends. Determine the length of need using procedures of 1130.5.2, Guardrails: Length of Need. Generally, embankments at bridges are steep and may also warrant guardrail protection.

#### *Gaps Between Warranting Features*

Avoid gaps in guardrail less than 200 feet where possible to minimize guardrail endings, which are obstacles.

#### *Road Approaches, Driveways, and Turnouts*

Where a road approach, driveway, or vehicle turnout interrupts a normal guardrail alignment parallel to the through roadway, or causes a guardrail section to be terminated short of the normal terminal point based on length of need, guardrail ends must be treated. You may do this with a Controlled Release Terminal or any DOT&PF-approved and NCHRP 350 Test Level 3 certified end terminal.

### **Other Guardrail Considerations**

One of the problems with guardrails is they must end somewhere. It is desirable to bury the rail end in the backslope. All guardrail ends must be anchored.

All upstream guardrail ends must be crashworthy. All downstream guardrail ends must be crashworthy except:

1. On one-way roadways

2. On divided highways or two-lane roadways where the downstream end is outside the clear zone for opposing traffic

Consider the use of crashworthy downstream terminals outside of the opposing traffic flow's clear zone when in the engineer's judgment it is likely that there will be a higher than normal incidence of vehicle encroachment beyond clear zone.

### **1130.5.3 Median Barriers**

The principles of guardrail usage are equally applicable to median barriers. However, median barriers additionally prevent errant vehicles from crossing the median area of divided highways and entering the opposing traveled ways. Therefore, they must be capable of containing and redirecting from two directions and on both sides.

Available median width may limit the choice of barrier. If a narrow median exists, a rigid barrier, which does not deflect into the opposing travel lanes, is necessary.

If space limitations present a borderline choice between rigid (concrete "safety shape") and semi-rigid (back-to-back blocked-out W sections) barrier, then take into account economic and other considerations for the particular site. While the concrete "safety shape" ("F-shape") barrier may have a slightly higher initial cost, yearly maintenance costs of the W-section barrier may be substantially more than that of the concrete median barrier. Sloped medians may require special consideration. See 2002 *AASHTO Roadside Design Guide*.

A true median barrier usually requires a different end treatment than a single guardrail unless the median widens sufficiently to terminate outside the clear zones of the two roadways, in which case only structural (anchorage) considerations are mandatory.

Operational median barrier end treatments consist of those in the *2002 AASHTO Roadside Design Guide*.

Again, eliminate gaps where possible. Coordination with emergency services and enforcement agencies in the design stage may allow elimination of unnecessary emergency crossovers.

### **Warrants for Median Barriers**

Low speed and intermediate speed urban section roadways generally do not require median barriers. Rural section intermediate speed roadways and all high-speed roadways may require median barriers.

Section 6.2 of the *AASHTO 2002 Roadside Design Guide* provides information on median barrier applications and warrants procedures. Median barrier warrants for rural intermediate and all high-speed roadways are shown in Figure 6.1 of the *AASHTO 2002 Roadside Design Guide*.

#### **1130.5.4 Bridge Rails**

Refer to Section 1120.3.5 and Chapter 7 of the *AASHTO 2002 Roadside Design Guide* for information on Bridge Rails. The “Alaska Two Tube” Bridge Rail is used for new projects. The Department’s Bridge Section supplies the drawings on a project-by-project basis. Transition drawings are in the standard drawings (G-30.00 and G-31.00).

#### **1130.5.5 Crash Cushions**

Crash cushions are sometimes used to absorb vehicle energy at a rate that is tolerable to the average, properly restrained vehicle occupant. In many cases, such as at elevated gore areas and bridge piers in medians at underpasses, they should also provide for redirection in side-angle impacts to alleviate pocketing near the fixed object.

Crash cushions are usually corrective measures, but may be included in the design phase if there is no feasible alternative, or if the crash cushion is the more cost-effective treatment. For example, at a rural, immovable “point” obstacle where the likelihood of impact is relatively small but the consequences of such impact great, it may be better to install a crash cushion, as opposed to a length of guardrail, to keep the collision cross-section small.

Continuing maintenance considerations for crash cushions is extremely important. For proper performance, almost all crash cushions depend on meticulous attention to functional details during installation, routine maintenance, and post-crash replacement or rehabilitation.

Refer to Chapter 8 of the *AASHTO 2002 Roadside Design Guide* for additional information about crash cushions. For areas of documented repeat impacts, consider using low maintenance or reusable crash cushions, which can be reconstructed in place. Chapter 8, Section 8.4.4 and Table 8.5 of the 2002 *AASHTO Roadside Design Guide* have additional information, including maintenance and crash repair.

#### **1130.5.6 Guardrail End Terminal Replacement**

Replace guardrail terminals in accordance with Table 1130-12.



**Table 1130-9  
Recommended Shy Line Offsets**

<u>Design Speed (mph)</u>	<u>Recommended Shy Line Offsets (feet)</u>
80	12.1
75	10.5
70	10.0
60	8.0
55	7.2
50	6.5
45	5.5
40	5.0
30	3.5

**Table 1130-10  
Flare Rates for Barrier Design  
(b/a)**

<u>Design Speed (mph)</u>	<u>Flare Rate for Barrier inside the Shy Line (b/a)</u>	<u>Flare Rate for Barrier Beyond Shy Line (b/a)</u>	
70	1:30	1:20*	1:15**
60	1:26	1:18*	1:14**
55	1:24	1:16*	1:12**
50	1:21	1:14*	1:11**
45	1:18	1:12*	1:10**
40	1:16	1:10*	1:8**
30	1:13	1:8*	1:7**

\* Suggested maximum flare rate for rigid barrier systems.

\*\* Suggested Maximum flare rate for semi-rigid systems.

**Table 1130-11  
Recommended Runout Lengths for Barrier  
Advancement Length Determinations**

	Traffic Volume (ADT)			
	Over 10,000	5,000 to 10,000	1,000 to 4,999	Under 1,000
Design Speed (mph)	Runout Length LR (ft)	Runout Length LR (ft)	Runout Length LR (ft)	Runout Length LR (ft)
70	360	330	290	250
65	330	290	250	225
60	300	250	210	200
55	265	220	185	175
50	230	190	160	150
45	195	160	135	125
40	160	130	110	100
35	135	110	95	85
30	110	90	80	70

Notes: Values are from Table 5-10b of the 2011 RDG, except values for 35, 45, 55 and 65 mph are interpolated.

$$X = \frac{L_H - L_2}{\frac{L_H}{L_R}}$$

**Tangent only**

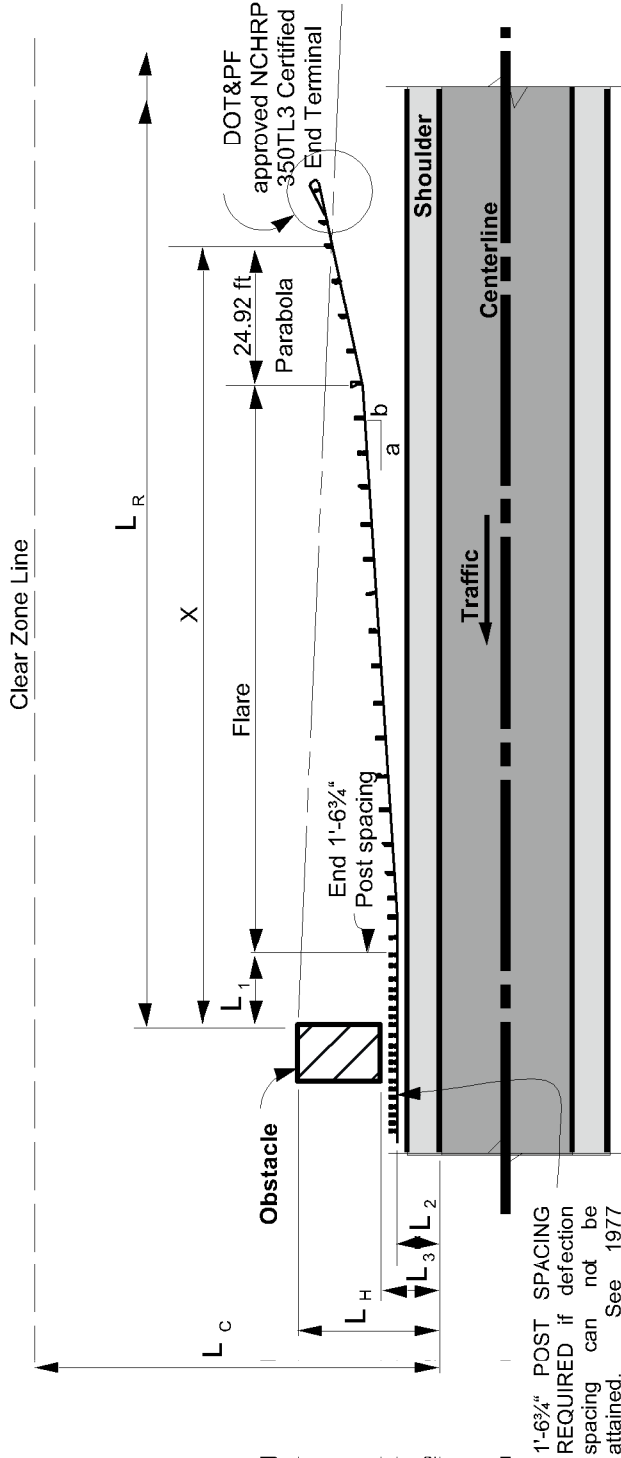
$$X = \frac{L_H - L_2 - P}{\frac{L_H}{L_R}}$$

**Tangent + Parabola**

$$X = \frac{L_H - L_2 + \frac{b}{a} L_1 - \frac{a(P)}{\sqrt{a^2 + b^2}}}{\frac{L_H + \frac{b}{a} L_R}{L_R}}$$

**Tangent + Flare + Parabola**

Parabola Type	P, offset in feet
Buried in Backslope	5.00
SRT-350	1.79



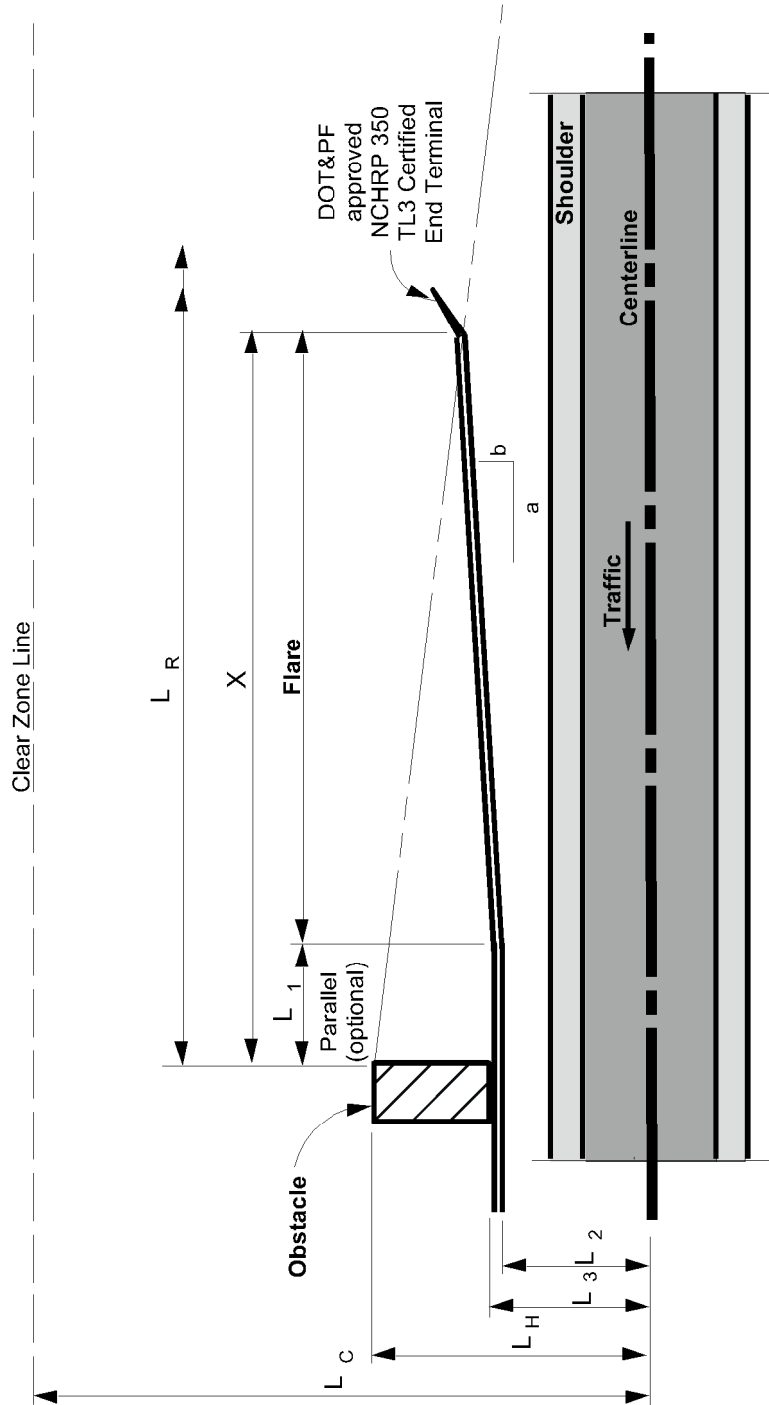
**BARRIER ADVANCEMENT LENGTH for G-4S & G-4W**  
**BEAM GUARDRAIL with APPROVED END TREATMENT**

All Units = feet  
unless otherwise noted

**Figure 1130-4a**  
**Barrier Advancement Length for G-4S & G-4W Beam Guardrail with Approved End Treatment**

$$X = \frac{L_H - L_2}{\frac{L_H}{L_R}} \quad \text{Tangent only}$$

$$X = \frac{L_H + \left(\frac{b}{a}\right)(L_1) - L_2}{\frac{b}{a} + \frac{L_H}{L_R}} \quad \text{Tangent + Flare}$$



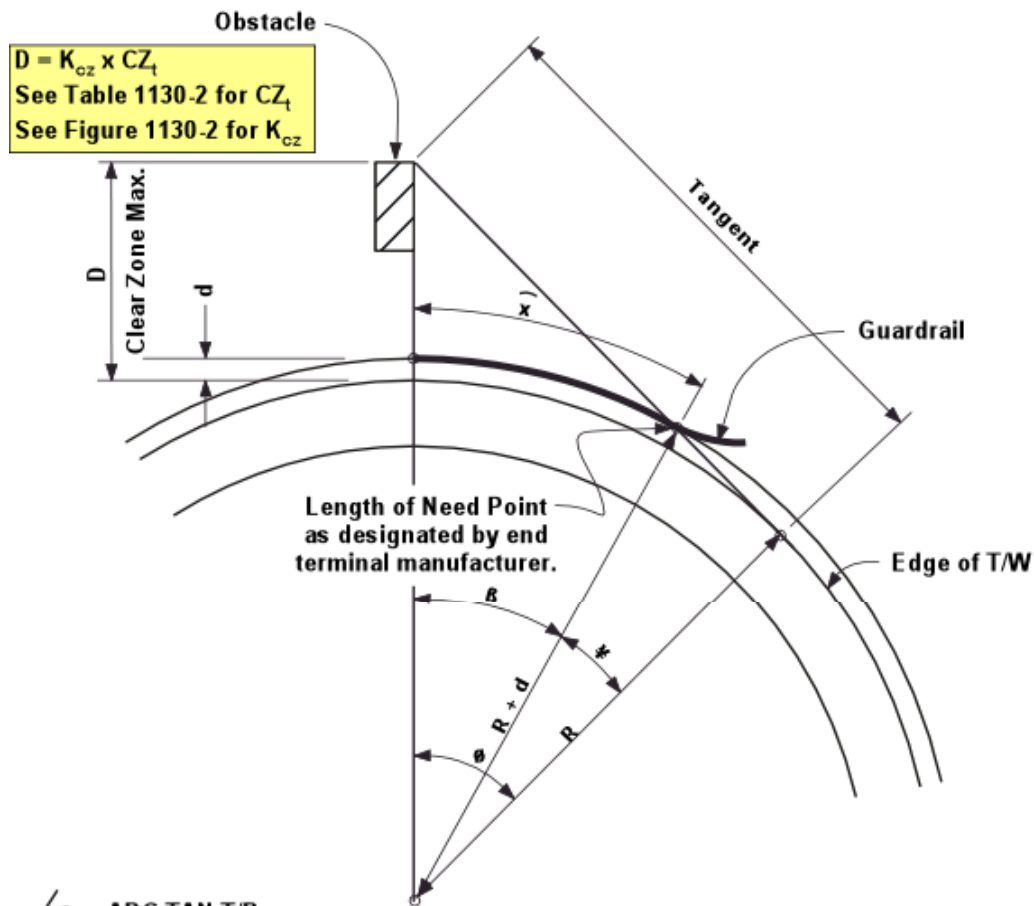
**RIGID BARRIER ADVANCEMENT LENGTH**

All Units = feet

Flare rates are not used on horizontal curves

**Figure 1130-4b  
Rigid Barrier Advancement Length**

**TRAFFIC BARRIER ADVANCEMENT  
LENGTH on OUTSIDE of HORIZONTAL CURVE  
TANGENT  $\leq L_R$**



$\angle \theta = \text{ARC TAN } T/R$   
 $\angle \phi = \text{ARC COS } R / (R+d)$   
 $\angle B = \theta - \phi$   
 $\widehat{X} = \pi(R+d) B / 180$

$T = \text{Tangent (feet), } T = \sqrt{(R + D)^2 - R^2}$   
 $L_R = \text{Runout Length Table 1130 -11}$

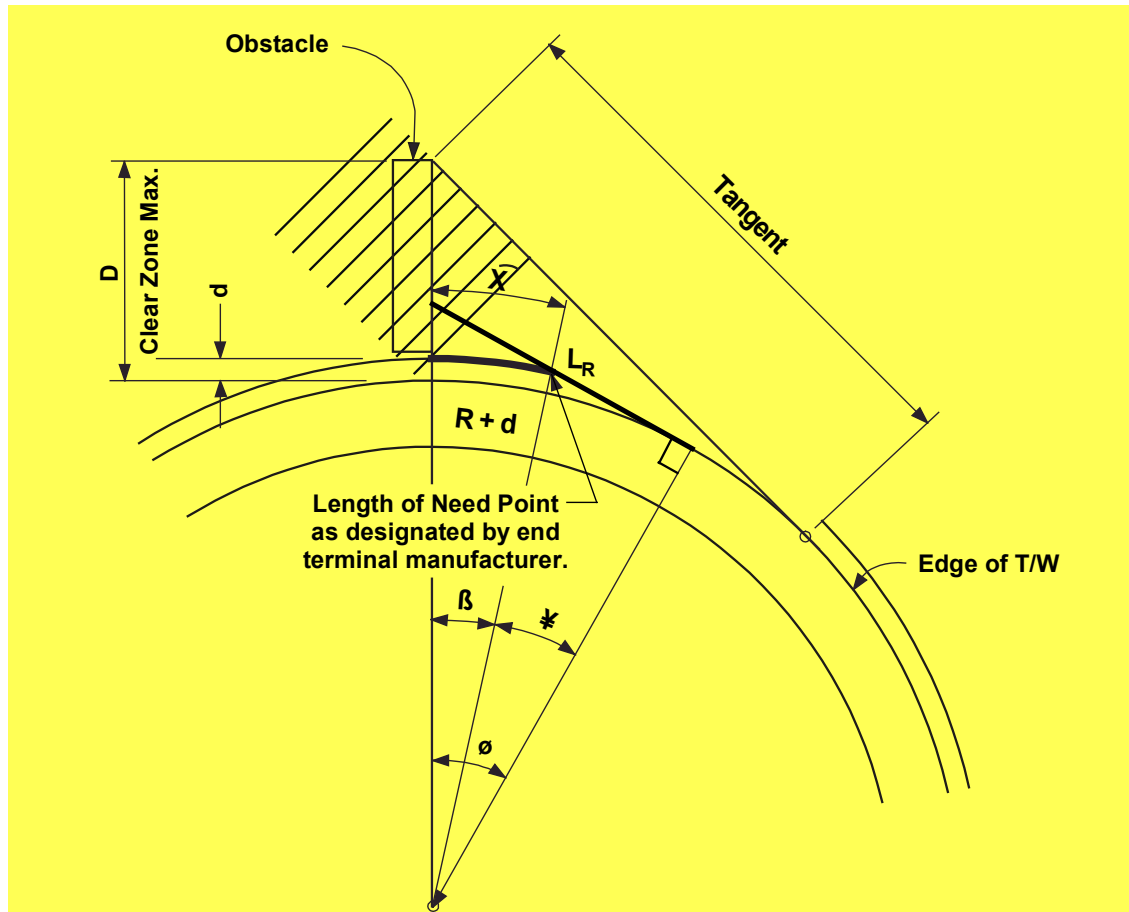
$R = \text{Radius to edge T/W}$   
 $D = \text{Distance from edge T/W to back of hazard}$   
 $d = \text{distance from edge T/W to face barrier}$   
 $\widehat{X} = \text{Advancement Arc Length}$

*Flare rates are not used on horizontal curves*

**Figure 1130-5  
Traffic Barrier Advancement Length on Outside of Horizontal Curve Tangent  $\leq L_R$**

**TRAFFIC BARRIER ADVANCEMENT  
LENGTH on OUTSIDE of HORIZONTAL CURVE**

**TANGENT > L<sub>R</sub>**



$$\angle \phi = \text{ARC TAN } (L_R/R)$$

$$\angle \gamma = \text{ARC COS } R / (R+d)$$

$$\angle \beta = \phi - \gamma$$

$$\widehat{x} = \gamma (R+d) \beta / 180$$

$$T = \text{Tangent (feet), } T = \sqrt{(R + D)^2 - R^2}$$

$$L_R = \text{Runout Length Table 1130 -11}$$

$R$  = Radius to edge T/W

$D$  = Distance from edge T/W to back of hazard

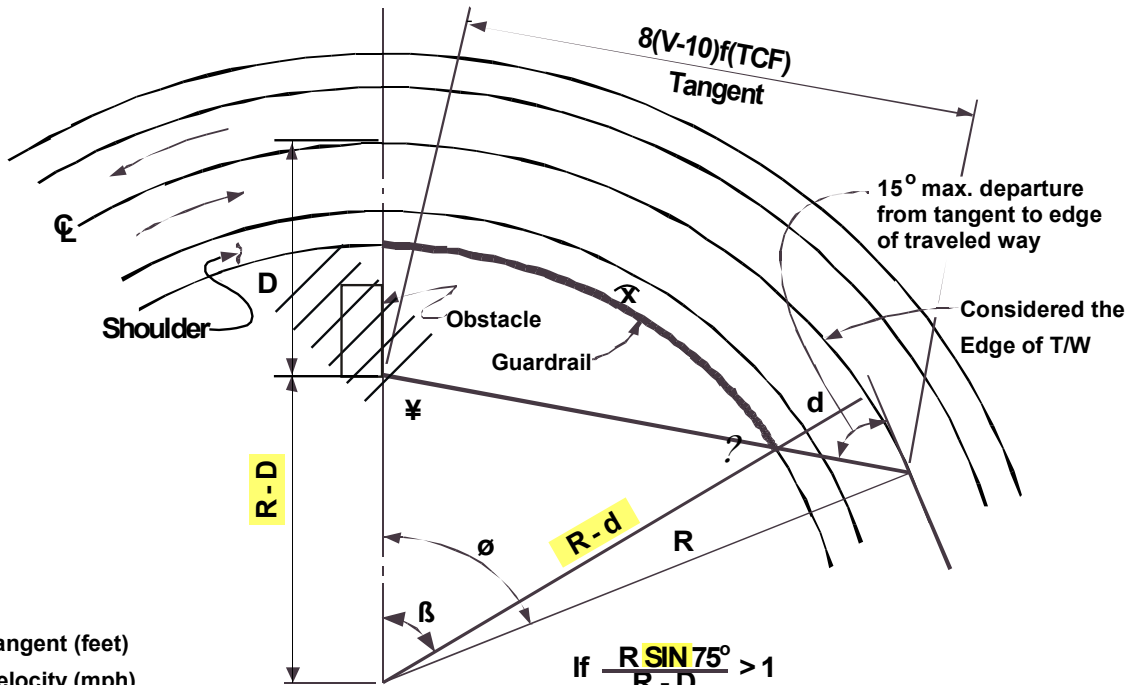
$d$  = distance from edge T/W to face barrier

$\widehat{x}$  = Advancement Arc Length

*Flare rates are not used on horizontal curves*

**Figure 1130-6  
Traffic Barrier Advancement Length on Outside of Horizontal Curve Tangent > L<sub>R</sub>**

# TRAFFIC BARRIER ADVANCEMENT LENGTH on INSIDE of HORIZONTAL CURVE



T = Tangent (feet)  
 V = Velocity (mph)  
 R = Radius to edge T/W  
 D = Distance from edge T/W to back of hazard  
 d = distance from edge T/W to face barrier  
 x̂ = Advancement Arc Length

If  $\frac{R \sin 75^\circ}{R-D} > 1$   
 Then evaluate as if on a tangent section.

If  $\hat{x} \gg 8(V/2) f(TCF)$  then the curve is too shallow and should be treated as a tangent.

Tangent Correction Factors (TCF)	
Design Speed (mph)	TCF
40	0.923
45	1.000
50	1.000
55	1.000
60	1.000
65	1.048
70	1.091

$$\angle \phi = 2 \text{ ARC TAN } r$$

$$\angle ? = \text{ARC SIN } \frac{(R-D) \sin \phi}{R-d}$$

$$\angle \beta = 180 - \phi$$

$$\hat{x} = ? (R-d) \beta / 180$$

$$S = 1/2 [2R - D + 8f(V-10) (TCF)]$$

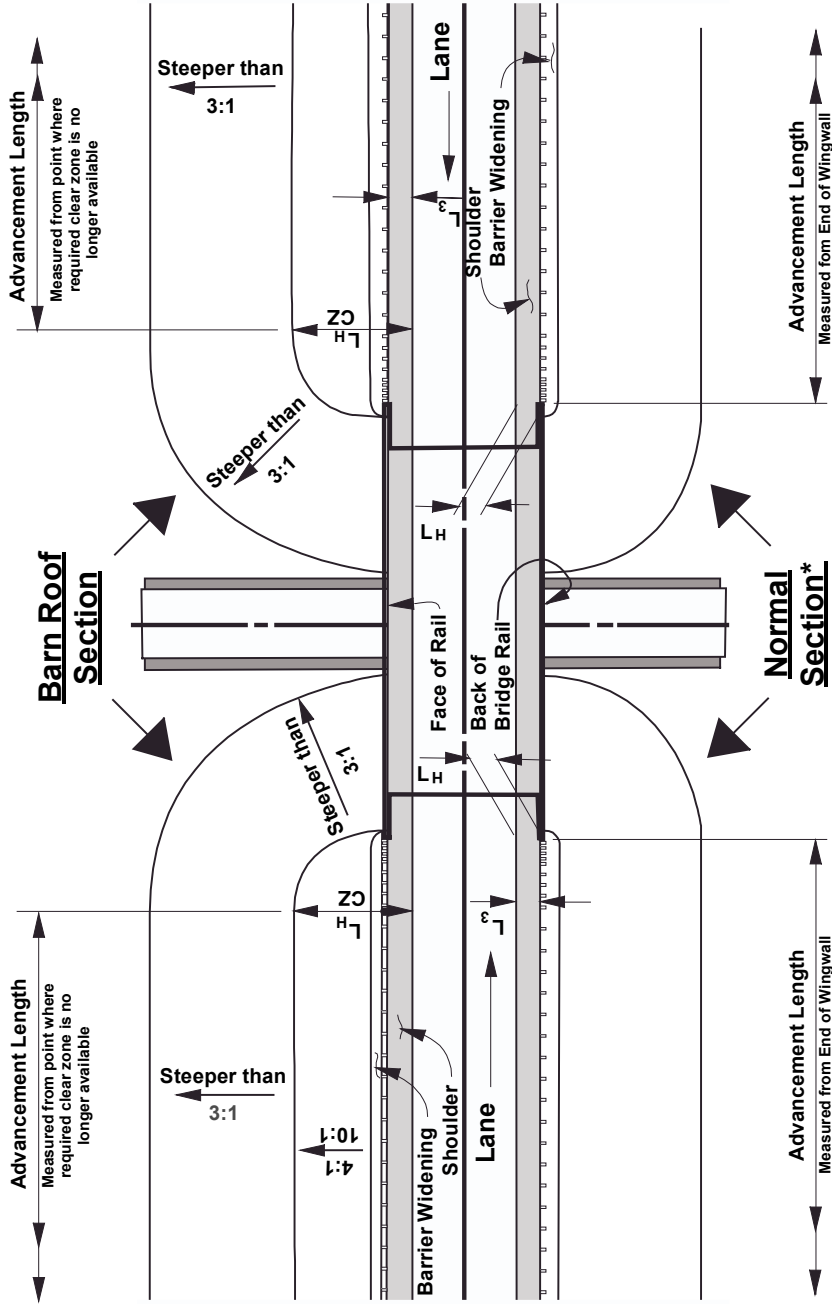
$$r = \sqrt{\frac{[S-R+D] [S-8(V/2) f(TCF)]}{S[S-R]}}$$

ADT Factors	
Design ADT	f
> 6,000	1.00
2,000-6,000	0.90
800-2,000	0.82
250-800	0.75
< 250	0.67

Figure 1130-7  
 Traffic Barrier Advancement Length on Inside of Horizontal Curve

# BARRIER ADVANCEMENT LENGTH @ BRIDGE APPROACHES

## PARALLEL WINGWALLS



$L_H$  = Distance from edge of traveled way to back of the Hazard  
 $L_{3"}$  = Distance from the edge of traveled way to the face of barrier  
 "3" is measured from the end of the bridge railing.

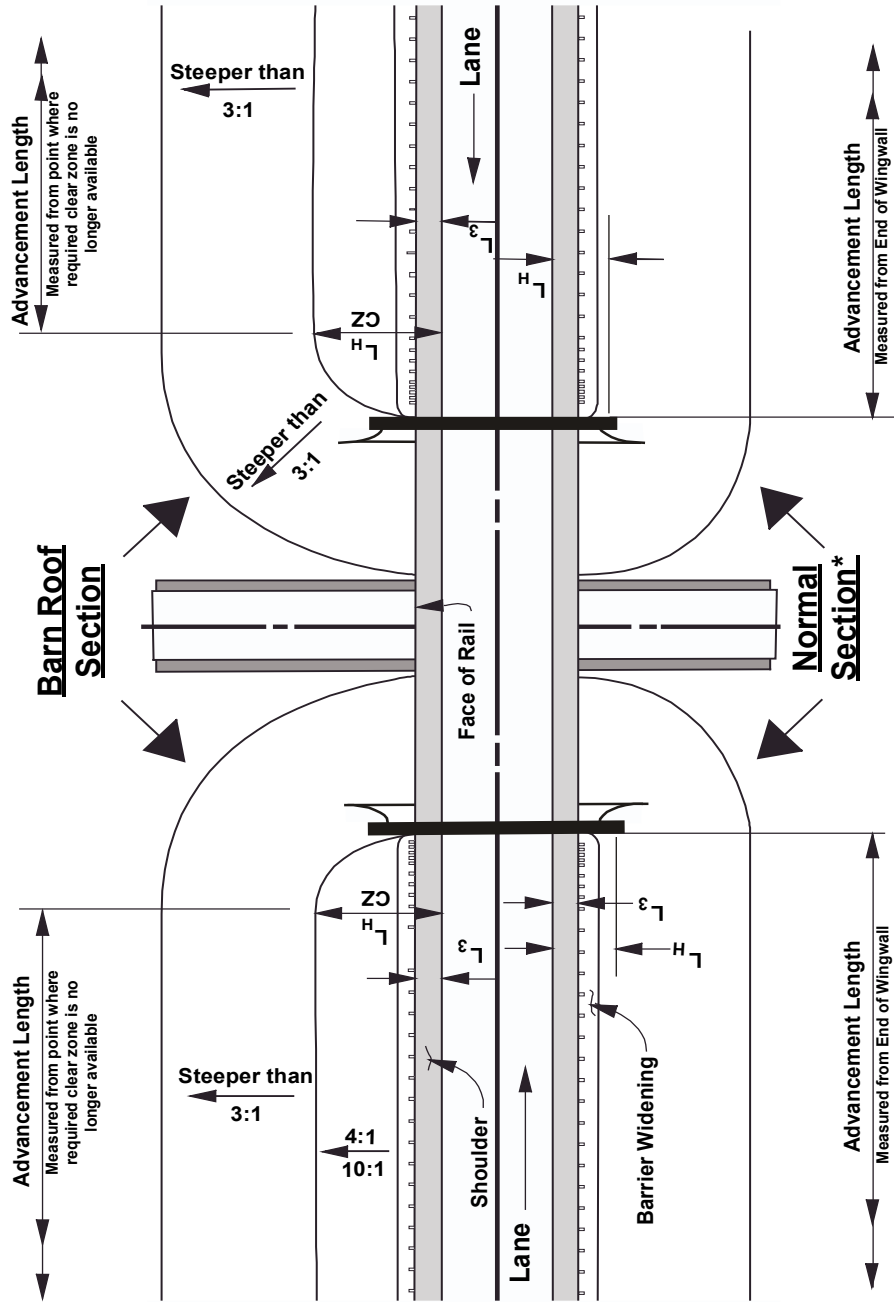
\* "Normal Section" indicates clear zone requirements are satisfied to or past end of wingwall.

Figure 1130-8a  
 Barrier Advancement Length at Bridge Approaches (Parallel Wingwalls)



# BARRIER ADVANCEMENT LENGTH @ BRIDGE APPROACHES

## Perpendicular Wingwalls



$L_H$  = Distance from edge of traveled way to back of the Hazard.  
 $L_3$  = Distance from the edge of traveled way to the face of barrier.  
 "3" is measured from the end of the bridge railing.

\* "Normal Section" indicates clear zone requirements are satisfied to or past wingwall.

Figure 1130- 8b  
 Barrier Advancement Length at Bridge Approaches (Perpendicular Wingwalls)

**Table 1130-12  
Guardrail End Treatment Replacement**

<b>Alaska DOT&amp;PF Guardrail End Terminal Replacement Requirements (Rev 8-2-02)</b>													
<b>Existing Guardrail End Terminal (GET)</b>	<b>Type of Project or Maintenance</b>	<b>Non-NHS</b>				<b>National Highway System (NHS)</b>							
						<b>Non-Hi Spd/Hi Vol</b>				<b>Hi Spd / Hi Vol</b>			
		<b>GET Condition</b>				<b>GET Condition</b>				<b>GET Condition</b>			
		<b>OK</b>	<b>Def- icient</b>	<b>Damage</b>		<b>OK</b>	<b>Def- icient</b>	<b>Damage</b>		<b>OK</b>	<b>Def- icient</b>	<b>Damage</b>	
<b>Major</b>	<b>Minor</b>			<b>Major</b>	<b>Minor</b>			<b>Major</b>	<b>Minor</b>				
Any or None	New Construction Projects	I350	I350	I350	I350	I350	I350	I350	I350	I350	I350	I350	I350
Breakaway	4R Projects	>40 MPH: R350	>40 MPH: R350	>40 MPH: R350	>40 MPH: R350	R350	R350	R350	R350	R350	R350	R350	R350
Cable	3R Projects (Including Gravel to Pavement)	RNR	RNR	RNR	RNR	R350	R350	R350	R350	R350	R350	R350	R350
Terminal	Surface Repair Maintenance Projects	RNR	RNR	RNR	RNR	R350	R350	R350	R350	R350	R350	R350	R350
(BCT)	State-funded maintenance (non-project)	RNR	RNR	>40 MPH: R350	RNR	RNR	RNR	R350	RNR	RNR	RNR	R350	R350
Turned Down	All projects (4R, 3R, Maintenance)	R350	R350	R350	R350	R350	R350	R350	R350	R350	R350	R350	R350
or Blunt Ends	State-funded maintenance (non-project)	RNR	RNR	R350	RNR	R350	R350	R350	R350	R350	R350	R350	R350

Note. Terminal replacement requirements may be waived for a current project if a separate guardrail project that will correct terminal deficiencies within the limits of the current project is included in the STIP and is scheduled to receive construction funding no later than one year after construction begins on the current project.

**Definitions**

**I350:** Install new NCHRP-350 compliant terminals conforming to current installation standards.

**R350:** Replace Non-NCHRP-350 compliant guardrail end terminals within project limits with Alaska-approved, 350-compliant terminals, with the following exceptions:

- 1) Upstream breakaway cable terminals outside of the clear zone for both directions of traffic.
- 2) Downstream breakaway cable terminals outside of the clear zone for the opposing direction of traffic.

When replacing a terminal, make sure embankment widening at the terminal conforms to standard drawing G-20. If not, grade and/or widen as necessary to achieve conformance. Consider relocating terminals if widening can be more easily constructed elsewhere (length of need must be verified where a relocated terminal would result in a reduced length of guardrail). If building embankment widening in accordance with G-20 is not feasible due to slope steepness, height and constraints on extension of the road footprint, the reasons for not doing it should be documented (in the design study report for design projects).

**>40 MPH R350:** Replace in accordance with R350 above if the speed limit is greater than 40 MPH. If the speed limit is 40 MPH or less, comply with RNR below.

**RNR:** Replacement Not Required: It is not mandatory to replace terminals with those that are 350-compliant. However, if terminals are not replaced, damaged parts still must be repaired. If terminals are replaced, replacements must be 350-compliant.

**Hi Spd / Hi Vol:** High-speed, high volume - 50 MPH or more and 6000 ADT or more.

**Table 1130-12 cont.**  
**Guardrail End Treatment Replacement**

**Surface Repair Maintenance Projects:** Surface repair projects funded under the federal Preventive Maintenance Program, not including crack sealing or projects that are eligible under the 3R program (3R-eligible projects must conform to the 3R requirements in the matrix). Preventive Maintenance Program projects include asphalt surface treatments, rut filling, profiling, and similar work and may be done either by DOT&PF maintenance or contractors.

**Deficient:** Deficient terminals include those that have, after project completion, improper flares, improper approach cross slope, rail height too high or low (lower than 24" or higher than 30" on strong-post W-beam), breakaway hardware stub height over 4", etc.

**Minor Damage:** Post and rail damage, no foundation damage, less than half of the terminal posts need replacement.

**Major Damage:** Damage to concrete foundations, or when half or more of the terminal posts need replacement

## 1130.6. Cost-Effective Analysis

### 1130.6.1 Introduction

A cost-effective analysis (CEA) is one that compares the benefits of an improvement to the cost of that improvement. This subsection focuses on roadway improvements where costs are borne by the Department and benefits accrued by the public.

The CEA procedures presented in Subsection 1130.6 apply to engineering analyses that compare alternatives with respect to the reduction of crash costs (fatalities, injuries, and property damage) to motorists.

The CEA procedures presented here do not apply to Highway Safety Improvement Program (HSIP) projects. See the HSIP Handbook for its own specific procedures.

### 1130.6.2 Procedure

The procedure presented here is an overview. Consult the ROADSIDE or RSAP User's Manual for more detailed procedures.

To perform a CEA, you must estimate the costs and benefits for a given alternative. These are calculated as an equivalent uniform annual cost for the design life of the roadway improvement.

#### Costs

The general formula for cost is:  $\text{Cost} = \text{Improvement Costs} + \text{Maintenance Costs} + \text{Accident Costs} + \text{Salvage Value}$ , where:

- **Improvement Costs** = Construction Costs + Right-of-Way Costs + Utilities Costs.
- **Maintenance Costs** = Cost of maintaining the roadside, including repairing and maintaining obstacles that are damaged by vehicular impacts.
- **Crash Costs** = Predicted or actual costs of fatalities, injuries or property damage due to vehicles impacting obstacles or hazards.

Costs for actual crashes come from crash reports that identify the type of crash and whether there were fatalities, injuries or property damage. These crash costs are

monetized so they can be compared to the cost of the improvement.

Actual crash data is obtained from the Department's statewide crash database. This data is reported in conformance with the Model Minimum Uniform Crash Criteria (MMUCC). Under the MMUCC crash report system, data is presented in the following format, with the corresponding KABCO value (refer to the Benefits section below) identified:

INJURY STATUS		KABCO Value
Code	Injury Description	
00	No Apparent Injury	O
01	Possible Injury	C
02	Suspected Minor Injury	B
03	Suspected Serious Injury	A
04	Fatal Injury (Killed)	K

Predicted crash costs come from the use of an engineering analysis program, which is discussed later.

- **Salvage Value** = Value of the material or hardware at the end of its economic life. The salvage value is commonly considered zero for highway applications.

#### Benefits

In order to determine the benefits of a roadway improvement alternative, it is necessary to monetize the value of reducing fatalities and injuries. The benefit of preventing one fatality is quantified by the Value of a Statistical Life (VSL). The VSL is not the valuation of life as such; rather, it is the valuation in reduction of risks.

The US DOT issues the VSL number and updates it periodically. The following KABCO values are derived from the VSL:

- K = Fatality = VSL
- A = Incapacitating Injury
- B = Non-incapacitating Injury (Evident)
- C = Possible Injury
- O = Property Damage

The KABCO values are used by engineering analysis programs to predict the crash costs of a

given alternative or existing condition. Official KABCO values and discount rates are updated annually and published on the Design and Engineering Services Preconstruction webpage located here:

<http://dot.alaska.gov/stwddes/dcsprecon/index.shtml>

There are two department approved analysis programs available for predicting crash costs for roadway improvements:

- ROADSIDE
- Road Side Analysis Program (RSAP)

ROADSIDE is an engineering analysis tool that determines the benefits and costs of a given alternative under consideration. The value of ROADSIDE is its ability to predict accident rates and crash costs associated with a given roadside model. It requires input of estimated costs and modeling of the roadway segment under analysis, including cross-sectional geometry, horizontal and vertical alignment, obstacles, et.al.

ROADSIDE was included with early versions of the AASHTO Roadside Design Guide (RDG) beginning in 1989. Copies of this program and its user manual can be found on the Design and Engineering Services Preconstruction webpage located here:

<http://dot.alaska.gov/stwddes/dcsprecon/index.shtml>

The RSAP (Roadside Safety Analysis Program) is a roadside evaluation model that was developed under National Cooperative Highway Research Program Project 22-9 to assist designers in benefit-cost analyses. It is similar to ROADSIDE in function.

RSAP was included with the RDG (Appendix A) beginning in 2002. Copies of the current RSAP program and user manual can be found on the Design and Engineering Services Preconstruction webpage located here:

<http://dot.alaska.gov/stwddes/dcsprecon/index.shtml>

Designers may use either, or both, of these programs and should apply engineering judgement in interpreting the results from their use.

### **CEA Procedure**

The discount rate, KABCO values, design life, and improvement costs need to be selected for use in the

selected analysis program. In addition, the roadway alignment and cross section geometry, including roadside hardware, need to be modeled and input into the analysis program. The analysis program will compute the uniform annualized cost and benefit for each alternative under consideration and provide the benefit-to-cost (B/C) ratio.

As illustrated in Figure 1130-9, evaluation of alternatives is based on the following order of precedence:

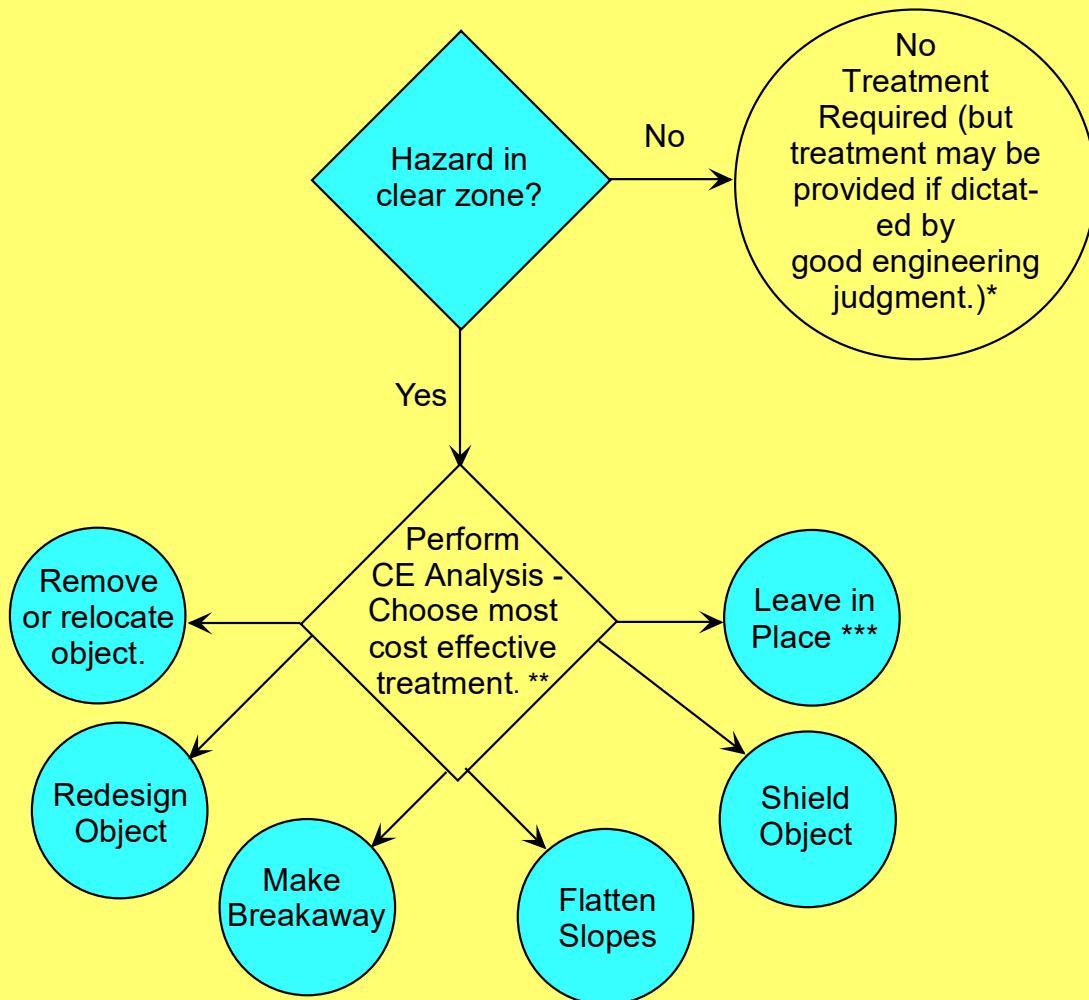
1. Remove the obstacle
2. Redesign the obstacle
3. Relocate the obstacle
4. Reduce the Severity of the obstacle
5. Shield the obstacle
6. Delineate the obstacle

An alternative with a B/C ratio greater than 1.00 is considered cost-effective; however, having a B/C ratio greater than one is not, in itself, sufficient justification for selection of a given alternative.

When comparing several alternatives, do not rely on the magnitude of the B/C ratio as the indicator of the best alternative. Use incremental B/C ratios to determine the most cost-effective solution. Consult the ROADSIDE or RSAP user's manual for further information on incremental B/C ratios and selection of the most cost-effective alternative.

Any alternatives under consideration that are within 10 percent of each other are essentially equal given the accuracy of estimating, analysis program modeling (user input), and analysis program output. The designer should ultimately use engineering judgement in selecting a final solution.

## **Process for Determining Treatment of Roadside Hazards for new construction and reconstruction projects**



CZ = Clear Zone

\* Instances where pedestrians congregate near roadways (such as school play yards or other high use pedestrian facilities), especially adjacent to the outside of curves on medium to high speed roadways and in areas with histories of run off the road type accidents, should receive special consideration.

\*\* Perform cost effective analysis in accordance with subsection 1130.6 of this section. If the engineering manager determines that the most cost effective treatment is not the desirable treatment present justification for selecting a less cost effective treatment in the design study report.

\*\*\* Delineate the hazard when in the judgment of the engineer delineation would be effective in reducing accident frequency or severity.

**Figure 1130- 9  
Process for Determining Roadside Treatments on New and Reconstruction Projects**

## 1130.7. Pedestrian Crossings

### 1130.7.1 Separation Structures for Pedestrian Crossings

#### Guidelines for Pedestrian Structures

A pedestrian grade separation may be considered if any of the following conditions (volumes, gaps, geometrics) are met:

#### Volumes

Consider pedestrian grade separations:

- When for each of any eight hours of an average day, the traffic volume is at least 600 vehicles per hour and the crossing pedestrian volume is at least 150 pedestrians per hour during the same eight hours; or
- When on an officially designated safe route to school, the vehicular volume is at least 400 vehicles per hour and the crossing school-age pedestrian volume during the same hour is at least 150 pedestrians, during any one-hour period of an average day.

#### Gaps

Consider pedestrian grade separations if all of the following requirements are met:

- 85<sup>th</sup> percentile speed of vehicles approaching the crossing site exceeds 40 mph
- The width of traveled way (exclusive of shoulders or median) exceeds 40 feet
- The average vehicular volume exceeds 750 vehicles per hour during the two heaviest pedestrian crossing hours
- There are less than 60 gaps per hour in the vehicular stream adequate for pedestrian crossings during both peak pedestrian crossing hours. Determination of gap adequacy (time required for pedestrian to cross) is presented in the ITE Recommended Practice “*A Program for School Crossing Protection.*”

$$\text{Gap Time} = \frac{W}{3.5} + 3 + (N - 1) \times 2 \quad \text{seconds}$$

W = Curb to curb width of roadway (feet)

N = Number of rows of pedestrians

#### Geometrics

Consider pedestrian grade separations if one of the following circumstances occurs:

- The available sight distance is less than the stopping sight distance required by the 85<sup>th</sup> percentile approach speed, and no other crossings are available for a distance of 500 feet from this location.
- A full freeway intersects a pedestrian way where no vehicular structure is to be built, and no other pedestrian crossing of the freeway is available within a minimum distance of 500 feet.

#### Access

##### Access Control

Prevent pedestrian access to the vehicular roadway by a 6-foot-high fence or other physical barrier for:

1. Five hundred feet each direction along both sides of the vehicular way from each end of the pedestrian structure
2. One thousand feet each direction along one side of the vehicular way from one end of the pedestrian structure, or
3. An unspecified distance each direction if the structure's use by pedestrians is guaranteed because the route via the structure requires substantially less time and effort than a route across the roadway at the vehicular grade

## 1140. Preservation Projects

---

### 1140.1. Introduction

Preservation projects are those that extend the service life of existing roadways and bridges by restoring them to a state of good repair. Preservation is a proactive approach to maintaining highway facilities while they are still in relatively good condition.

Preservation performed before the onset of serious damage delays or eliminates the need for major rehabilitation or reconstruction.

FHWA recognizes preservation as an essential and cost-effective tool for achieving and sustaining highway facilities in a state of good repair and supports the increased flexibility in using federal-aid funds for cost-effective preservation.

Preservation projects are categorized as follows:

1. Preventive Maintenance (PM) Projects
2. Resurfacing (1R) Projects
3. Resurfacing and Minor Restoration (2R) Projects

Resurfacing, Restoration and Rehabilitation (3R) projects are covered in Section 1160.

Routine Maintenance is not eligible for federal-aid funding.

### 1140.2. Project identification

Highway segments and bridges needing preservation are identified and prioritized through the Pavement Management System (PMS) and Bridge Management System. The policy and procedure for these are contained in P&P 07.05.020 and P&P 07.05.025, respectively.

Predictive modeling software uses information from the PMS, Bridge Management System and the Maintenance Management System (MMS) to identify locations that would benefit from preservation. The Pavement Management Engineer and the Bridge Management Engineer select from the software output to create a list of proposed locations, including recommended preservation actions. In addition, segments that are not candidates for preservation (i.e. needing a more substantial treatment) are submitted to Planning for consideration in the STIP. Finalized recommendations are included in the Annual Preservation Plan (APP). The final selection of locations are made by the Regions, which then feeds

projects into the Preservation Projects development pipeline.

### 1140.3. Project Scope

Preservation project scope depends on the preservation treatments needed. It is important to apply the right preservation treatment at the right time. Pavement Preservation projects do not add capacity or alter existing road geometry.

See Table 1140-1 for a summary of Pavement Preservation categories.

All pavement preservation projects are required to:

1. Assure replacement striping is in accordance with the *Alaska Traffic Manual* (ATM).
2. Assure rumble strips are replaced or installed to meet current DOT&PF policy.
3. Follow vertical clearance policy for structures and utility lines per Table 1130-1. If the existing vertical clearance is less than 18 feet or the resulting project improvements will result in a vertical clearance less than 18 feet, relocate the overhead utility with a minimum clearance of 20 feet. When mitigating factors exist, the relocated utility may be installed with a vertical clearance no less than 18 feet.
4. Include required ADA improvements (see Section 1140.4.3.).
5. Assure warning devices for any highway-rail grade crossings within the project limits or near the project terminus are installed and functioning properly per 23 CFR 646.214.
6. Maintain functionality of traffic signal vehicle detection and other ITS elements.
7. Adjust appurtenances (i.e., manholes, valve boxes, monuments, etc.) in pavement as necessary.
8. Approach bridge work in accordance with Section 1140.4.2.

Pavement preservation projects may also include mitigation of pavement edge drop offs per Section 1160.3.7, installation of a safety edge or safety improvements.



**Table 1140-1  
Pavement Preservation Project Categories**

<b>Project Scope</b>	<b>Category</b>	<b>Purpose</b>	<b>Work Types</b>
Pavement Preservation	Preventive Maintenance (PM)	Keep good roads in good condition	Typically pavement seals - fog, sand, scrub, chip seals
	Resurfacing (1R)	Restore fair roads to good condition. Address surface defects beyond preventive maintenance, such as ruts, or areas of high roughness	Mill/fill, overlay or other resurfacing treatment limited to 2" of new HMA
	Resurfacing & Minor Restoration (2R)	Restore roads beyond preventive maintenance or resurfacing to good condition	Mill/fill, overlay or reclamation with an overlay limited to 2" of HMA. Reclamation can include base stabilization.

**1140.3.1. Preventive Maintenance Projects**

Preventative Maintenance (PM) is the lowest level preservation strategy utilized by the PMS and a cost-effective, proactive means of extending the useful life of highways and bridges. PM slows or delays future deterioration and maintains or improves the functional condition of highway and bridge facilities. PM projects should consider maintaining or enhancing the current level of safety and accessibility. Consider addressing isolated or obvious deficiencies.

Typical activities performed on PM projects include:

1. Crack sealing
2. Profiling
3. Milling
4. Microsurfacing
5. Fog sealing
6. Sand sealing
7. Chip sealing
8. Scrub sealing
9. Roadway surface (gravel) replacement
10. Area-wide or system-wide activities:
  - a. Systematic replacement and/or upgrade of light and signal poles, light fixtures, signal heads, signal bulbs or LEDs near the end of their service life, and bases

- b. Area-wide striping
- c. Systematic sign replacement

This list is only a summary of work items previously determined to be federal-aid eligible after consultation with FHWA. Consult with FHWA regarding eligibility on work items not included in this list.

**1140.3.2. 1R Projects**

1R projects focus on resurfacing and typically have a pavement design life of five to 10 years. A capacity screening analysis is not required for this short duration design life. A safety screening is not required, but addressing known safety issues or enhancing the existing level of safety may be considered.

1R projects:

- May include any work allowed on PM projects
- Do not alter roadway geometry
- Minimizes fill beyond the existing slope limits
- Do not typically include guardrail work, unless approved by the Preconstruction Engineer
- May include structural section replacement, or digout, limited to 25% of the project area(s) – (example: digout existing structural section to 48 inch depth and replace with new structural section for 25% of project area).

**1140.3.3. 2R Projects**

2R projects focus on resurfacing and minor restoration, and may include minor rehabilitation

work. Minor rehabilitation consists of enhancements to eliminate age-related, top-down surface cracking in flexible pavements that develop due to environmental exposure. Thin overlays (of 2 inches or less) over recycling treatments (hot in-place recycling or cold recycling) are considered minor rehabilitation activities.

2R projects:

- Are cost-effective preservation projects done on facilities that are in a state of good repair and do not require rehabilitation (3R) or Reconstruction
- Do not alter roadway geometry
- Address safety through a Safety Screening
- Check capacity through a Capacity Screening. Projects needing capacity improvements are not good candidates for 2R
- Consider installing, replacing or upgrading guardrail and guardrail end treatments

Work allowed on 2R projects includes:

- Any work allowed on a PM or 1R project.
- Treatment of roadside obstacles
- Upgrade non-crashworthy sign supports in the clear zone, except those permitted under 17 AAC 10 and 17 AAC 60
- Repair drainage, but only as required for the structural integrity of the roadway, or to restore function which has deteriorated

2R projects typically have a 10-year minimum pavement design life. This design life length warrants both a capacity screening and safety screening.

### Safety Screening

Regional Traffic and Safety will review the latest available Safety Screening lists summarized through the HSIP Program. Use this data to identify those segments or intersections that need to be addressed on the project, based on the following criteria:

- The overall five-year crash rate or crash frequency (concentration) exceeds 1.5 times the statewide average\*
- The overall fatal and serious injury crash rate or crash frequency (concentration) exceeds 1.5 times the statewide average\*

\* **Notes** (to the bulleted list above):

1. Obtain the statewide crash rate from Statewide Traffic & Safety.

2. A three-year rate or frequency may be used in the absence of five years of available data.
3. Crash rate screening is not applicable for ADT's of less than 2,000 vehicles per day.
4. Crash frequency (concentration) applies at all traffic volumes.

Other safety elements to consider for improvement include:

- Segments or intersections listed on other HSIP Program screening lists for serious injury and fatal crashes. These may include crash strategies listed in the Alaska Strategic Highway Safety Plan.
- All affected railroad crossings, school zones, and marked non-motorized crossings

In addition, review other recent Reconnaissance and Design Study Reports in the project location to identify segments of safety concern. Any other safety concerns previously raised by the public or other stakeholders may also be considered for inclusion during design development.

If a 2R project is unable to address the issues identified in the Safety Screening, a 3R, HSIP, or other type of project should be developed.

### Capacity Screening Analysis

A simplified highway capacity calculation method (such as FHWA Report PL-18-003) may be used to determine if there is sufficient capacity to support existing and projected vehicular traffic volumes for the design life of the project.

If the Capacity Screening analysis indicates the roadway cannot handle projected traffic volumes, develop it as a 3R or Reconstruction project.

## 1140.4. Project Development and Design

Preservation projects generally follow the project development and highway design standards detailed in Chapter 4 and Chapter 11 of this *Manual*, respectively, and those found in the *Alaska Flexible Pavement Design Manual* and the *Alaska Bridges and Structures Manual*.

### 1140.4.1. Pavement Design

The Pavement Management Engineer provides recommendations for pavement preservation needs. Regional staff may contact the Pavement Management

Engineer for treatment recommendations. If there is no recommendation, the project manager develops the preservation strategy and pavement design. Prepare pavement designs in accordance with the *Alaska Flexible Pavement Design Manual*. Per general policy statement GP-1, a pavement design analysis is only required on arterials and interstates.

#### **1140.4.2. Bridge Work**

Evaluate bridges in *fair* or *good* condition located within the limits of Preservation Projects. Bridges in poor condition may also be considered; however, they will generally require major rehabilitation or replacement, which are beyond the scope of preservation.

See Table 23-1 of the *Alaska Bridges and Structures Manual* (ABSM) for bridge railing criteria for all project types.

See the *FHWA Bridge Preservation Guide, Maintaining a Resilient Infrastructure to Preserve Mobility, Spring 2018*, for criteria for bridge preservation goals and activities.

#### **PM and 1R Projects**

Apply cost-effective deck surface treatments to bridges in *fair* or *good* condition to extend their service life. These treatments are typically either cyclical or condition-based maintenance activities.

Cyclical maintenance is performed at predetermined intervals and includes cleaning bridge decks, joints, drains and applying concrete sealers. Condition-based maintenance is commonly identified from bridge inspection reports and may include:

- Expansion joint cleaning, repair and replacement
- Deck sealing, overlays and wearing surfaces
- Railing repair

Note, routine maintenance activities (snow and trash removal, crash damage repair, storm damage repair, etc.) are not typically eligible for federal funding.

Evaluate existing surfacing and its impact on load ratings and bridge rail height. Remove existing asphalt surfacing and install waterproofing membrane on concrete decks that do not already have membrane or show signs of excessive leakage. Limit new surfacing thickness to avoid significantly changing load ratings and bridge rail height.

Evaluate vertical clearances at all overcrossings and undercrossings regardless of bridge condition.

Consider the impact of new surfacing on the vertical clearance beneath these structures.

#### **2R Projects**

Perform the same evaluations as for PM and 1R Projects. Additionally, consider the following preservation treatments, rehabilitation and replacement strategies as defined in Section 10.2.3 of the ABSM:

- Crack sealing and concrete spall repairs
- Channel debris removal
- Scour countermeasures
- Railing retrofit and replacement
- Painting and metalizing structural steel

#### **1140.4.3. ADA Improvements**

Projects considered alterations are required to make certain simultaneous ADA upgrades while projects considered maintenance are not.

Maintenance includes:

- Chip seals
- Crack filling and sealing
- Diamond grinding
- Dowel bar retrofitting
- Fog seals
- Joint crack seals
- Joint repairs
- Pavement patching
- Scrub sealing
- Slurry seals
- Spot high-friction treatments
- Surface sealing

Alterations include:

- Addition of a new layer(s) of asphalt
- Cape seals
- Hot in-place recycling
- Microsurfacing / thin-lift overlays
- Mill & fill / mill & overlays

If a project is considered an alteration, and there are adjacent pedestrian walkway amenities, then curb ramps and crosswalks must be constructed or improved to current ADA standards as part of the alteration project, except as noted in the following paragraphs.

If a curb ramp was built or altered prior to March 15, 2012, and complies with the requirements for curb ramps in either the 1991 ADA Standards for

Accessible Design or Uniform Federal Accessibility Standards (UFAS), it does not have to be modified to comply with the requirements of the 2010 ADA Standards. However, if that existing curb ramp did not comply with either the 1991 Standards or UFAS as of March 15, 2012, then the “safe harbor” provision does not apply and the curb ramp must be brought into compliance with the requirements of the 2010 ADA Standards concurrent with the road alteration.

Any features disturbed by construction must be replaced so they are accessible, even on maintenance projects. Pedestrian amenities other than curb ramps and crosswalks, such as sidewalks, paths, bus stops, etc., do not require upgrading as part of an alteration project, but should be evaluated for accessibility and any identified deficiencies noted.

When existing curb ramps and crosswalks meeting 1991 ADA Standards or UFAS will remain in place, transmit this information to the Civil Rights Office (CRO). Inform the CRO of any known accessibility deficiencies within the public right-of-way for inclusion into the Transition Plan. The Transition Plan identifies non-compliant features and serves as a guide for future planning and prioritization of ADA improvements.

#### **1140.4.4. Design Study Report (DSR)**

Preservation projects do not require a DSR. On 2R projects, safety and capacity analyses are retained in the project design files.

#### **1140.5. References**

1. FHWA Guidance on Highway Preservation and Maintenance, dated Feb. 5, 2016
2. US DOJ/US DOT joint technical assistance on requirement to upgrade curb ramps on resurfacing projects:
3. Q & A for Supplement to the 2013 DOJ/DOT Joint Technical Assistance on the Title II of the Americans with Disabilities Act Requirements To Provide Curb Ramps when Streets, Roads, or Highways are Altered through Resurfacing (Safe Harbor provisions discussed in Q1/A1)
4. FHWA Office of Civil Rights guidance document. FAQs on ADA and Section 504. Discussion of transition plans, timing of accessibility improvements, and other relevant topics.

5. FHWA Good Practices: Incorporating Safety into Resurfacing and Restoration Projects, dated Dec. 2006.

This page intentionally left blank.

## 1150. Urban Roads

---

- 1150.1. Urban Streets Roadway Width Guidelines
- 1150.2. Urban Arterials

### 1150.1. Urban Streets Roadway Width Guidelines

Intersection and street lanes are determined through capacity analysis procedures presented in HCM2000. The number and movement assignments for lanes are configured to meet level of service guidelines in American Association of Street and Highway Transportation Officials' *A Policy on the Geometric Design of Highways and Streets 2001(GB)*. Reference the GB for lane widths, shoulder widths, and other cross-sectional element requirements.

### 1150.2. Urban Arterials

#### 1150.2.1. General Design Considerations

Design of urban arterials shall conform to recommendations in the GB.

#### 1150.2.2. Medians

Median openings generally permit cross traffic and left turns, which conflict with the through traffic on the arterial. These conflicts result in delays and accident exposure, which you can minimize by providing as few median openings as possible. However, keep in mind that restriction of mid-block left turns often substantially increases the number of U-turns at the adjacent intersection with median openings. A similar situation exists where a minor street intersects the arterial and does not provide a median opening.

Generally, provide median openings only if the volume of cross- or left-turn traffic is relatively large, such as at another arterial or major collector street or, in some cases, at an access point to a major traffic generator, such as a regional shopping center or industrial plant. Because the openings are at major traffic points, assume that at some time, if not immediately, these median opening locations will be signalized. Additionally, where signalized intersections are 0.5 mile or less apart, efficiency and safety require interconnected or synchronized signals to achieve smooth traffic flow along the arterial.

One of the most critical design criteria for smooth, two-way operation of a signalized arterial is to evenly

space signalized intersections along the arterial. It is not necessary that the distance between signalized intersections be exactly even, provided the longer distances are integer multiples of the ultimate minimum spacing. As indicated above, assume that every median opening will eventually be signalized and hence, median openings should be evenly spaced or spaced at integer multiples along the arterial.

The minimum distance between median openings is also critical if reasonable progression speed is to be achieved along the arterial. Analysis of progression is most efficiently performed with software that is specifically designed for that purpose. The longer the distance and/or the shorter the cycle, the better the progression speed. The progression speed should approximate the average running speed along the arterial and should be greater than 25 mph, preferably greater than 30 mph, for a normal divided urban arterial.

As a rule, alternating signals should be greater than 0.25 mile apart. Although you may achieve closer spacing between signalized intersections by using simultaneous signal groups with alternating group displays, be aware that when using adjacent simultaneous signals, the available green time for continuous through-movements on the arterial is substantially reduced.

In addition to signal progression considerations, median openings should be sufficiently spaced to provide adequate length for storage in the left turn lane and an appropriate length taper. Turn lane lengths should be designed to meet storage and deceleration requirements presented in Table 1150-1. Storage, or queue lengths, should be determined through methods in the HCM2000 or through simulation software. Deceleration length should be determined through methods presented in the GB.

A minimum length should accommodate one 60-foot truck regardless of turning volume.) Space median openings to accommodate the full length of the left turn lane, including taper. Lane and taper requirements are found in the GB and the Alaska Traffic Manual.

Table 1150-2 presents recommended median widths for urban streets.

**Table 1150-1  
Auxiliary Lane Length Guidelines**

Unsignalized Intersections			References
Approach	Length Component		NCHRP 457
	Left-Turn Bay	Right-Turn Bay	
Free-flow, Main Street	Storage & Deceleration	Deceleration	
Stopped, Minor Street	Storage	Storage	
Signalized Intersections			
Approach Speeds	Left-Turn Bay	Right-Turn Bay <sup>1</sup>	NCHRP 279
30-35 mph	Storage	Storage	
40-45 mph	Storage & Deceleration	Storage & Deceleration	
> 50 mph	Storage & Deceleration	Storage & Deceleration	

<sup>1</sup>These guidelines are derived from left-turn recommendations presented in NCHRP 279

**References:** *NCHRP 457* Evaluating Intersection Improvements- An Engineering Study Guide, *NCHRP 279* Intersection Channelization Design Guide

Notes

- 1) It is desirable for all deceleration to occur outside of the through lanes. However, where constrained, the turning vehicle may enter the turn lane taper at 10 mph less adjacent through lane speeds.
- 2) The minimum turn lane length shall accommodate at least one design vehicle, but shall be no less than 100 feet.

**Table 1150-2  
Recommended Median Widths**

Median Function	Minimum Width (ft)
Separation of opposing traffic streams	4
Provide pedestrian refuge	6
Provide width for signs or appurtenances	4
Provide storage for left-turning vehicles	12
Provide protection for vehicles crossing the through lanes	18
Provide for U-turns, inside lane to outside lane	18
Provide for U-turns, inside lane to inside lane	30

## 1160. Resurfacing, Restoration, & Rehabilitation Projects (3R)

---

- 1160.1. Guidelines
- 1160.2. Factors
- 1160.3. 3R Geometric Design Standards
- 1160.4. Studies
- 1160.5. Gravel to Pavement

### 1160.1. Guidelines

#### 1160.1.1 General

This chapter presents the procedures for development of 3R projects in Alaska, which are cost-effective and enhance highway safety. These procedures are required where projects are federally funded or on federal-aid routes. In nonfederal projects, these procedures represent good engineering, but they are not mandatory.

#### 1160.1.2 Background

Prior to 1976, federal-aid highway funds were generally limited to participation in the new construction of highways. Preservation of the existing highways was a state or local agency responsibility.

By 1975, it became evident that many sections of the existing highway system were reaching the end of design life, and the rate of deterioration was exceeding the funding levels available for preservation. In recognition of this problem, Congress, in the 1976 Federal-Aid Highway Act, broadened the scope of the Federal-Aid Highway Program to include preservation work by adding resurfacing, restoration, and rehabilitation (3R) to the definition of construction under Title 23, USC, Section 101(a).

However, since many existing highways do not meet current design standards and have safety deficiencies, the amount of upgrading to current 3R project standards has been a continuing concern. This concern was recognized in the 1982 Surface Transportation Assistance Act, Section 101(a), which emphasizes safety by stating that 3R projects “shall be constructed in accordance with standards that preserve and extend the service life of the highways *and enhance highway safety.*” (Emphasis added.)

#### 1160.1.3 Definition

Rehabilitation (3R) projects consist of the resurfacing, restoration, and rehabilitation of an existing roadway

on the same alignment or modified alignment. The principal objective of 3R projects is to restore the structural integrity of the existing roadway, thereby extending the service life of the facility. In addition, the safety and capacity of the facility should be enhanced, if required.

Generally, a 3R project consists of the repaving or the asphalt paving of an existing gravel surface. It can also include drainage improvements and reconstruction of the structural section. Safety enhancements include improvement of deficient geometry identified by a performance criterion found in this section. Capacity enhancements include the addition of truck climbing lanes, passing lanes, and slow moving vehicle lanes. Turnouts may be added as safety enhancements where driver fatigue or sightseeing are factors in accidents.

Section 1160.5. describes a modified design procedure for non-NHS road construction projects whose primary purpose is to reduce maintenance costs and improve the quality of life for Alaskans by hard surfacing of gravel roads, but that may include limited shoulder, drainage, and other work related to preserving the road structure.

#### 1160.1.4 Determining the Type of Project

Follow normal project planning and programming procedures for determining the type of improvement: new construction, reconstruction on existing alignment, or restoring the existing facility (3R). This determination is specified on the Design Designation.

Select a design year that at least equals the expected life of the improvement. Designate the design year in five-year increments.

### 1160.2. Factors

Evaluate the following in determining type and scope of a project:

1. **Pavement Condition:** The existing pavement condition and the scope of needed pavement improvements dictate to a large extent what improvements are feasible. The project analysis should indicate how existing pavement condition



and the scope of pavement improvements will interrelate with the scope of geometric improvements and the values used for design of geometric improvements.

2. **Physical Characteristics:** The physical characteristics of a highway and its general location often determine what improvements are necessary, desirable, possible, practical, or cost-effective. Consider topography, climate, adjacent development, existing alignment (horizontal and vertical), cross-section (pavement width, shoulder width, cross slope, and sideslopes), and similar characteristics in determining the scope of geometric or safety improvements to be made in pavement-type 3R work.
3. **Traffic Volumes:** Traffic data are needed in the design of all highway improvements, including 3R. Traffic volume is an important consideration in determining the appropriate level of improvement (for example, reconstruction versus 3R) and in the selection of values for the various geometric elements.
4. **Traffic Controls and Regulations:** Signing and marking in all highway projects, including 3R, must conform to the *Alaska Traffic Manual* (ATM). Where roadway geometry or other roadway or roadside features do not meet the drivers' expectancy and reconstruction is not appropriate, consider additional signs, markings, and other devices beyond the normal requirements of the ATM. While traffic control devices cannot fully mitigate all problems associated with substandard geometric features, they can compensate for certain operational deficiencies. In addition, judicious use of special traffic regulations, positive guidance techniques, and traffic operational improvements can often forestall expensive reconstruction by minimizing or eliminating possible adverse safety and operational features of existing highways.
5. **Accident Records:** Accident records are an integral part of these 3R standards. It is necessary to reference the state reporting system to evaluate existing geometric features for accident performance. Generally, use a three- to five-year period. When evaluating historical accident records, examine each accident as a whole, regardless of the number of vehicles or people involved. Moose accidents and alcohol-related accidents are eligible. Obtain average accident rates from the January 25, 2002, DOT&PF *Highway Safety Improvement Program Handbook*.
6. **Skid Resistance:** A skid-resistant surface should be an essential part of any pavement surface improvement, regardless of the scope of geometric problems or improvements. The Alaska design method for asphalt pavement provides a skid-resistant surface. Portland cement concrete requires a broom or similar finish.
7. **Economics:** By their purpose and definition, 3R projects reflect and emphasize the economic management of the highway system. The purpose of 3R is to prolong and preserve the service life of existing highways and to enhance highway safety to protect the investment in, and derive the maximum economic benefit from, the existing highway system. Economic considerations should be a major factor in determining the priority and scope of 3R work.
8. **Potential Impact of Various Improvements:** Often, development and effects on the land influence the scope of geometric improvements made by 3R projects. Typically, social, environmental, and economic impacts severely limit the scope of 3R projects, particularly where the existing right-of-way is narrow and there is considerable adjacent development.

## **1160.3. 3R Geometric Design Standards**

### **1160.3.1 General (Design Exceptions)**

Design all 3R-type projects using the 3R design criteria found in this section. Design standards for 3R projects that are not in this section shall be dictated by the remaining applicable sections of Chapter 11 and the current *AASHTO A Policy on the Geometric Design of Highways and Streets 2001*. All signing and pavement markings must conform to the *Alaska Traffic Manual*. Upgrade all warranted guardrail terminals and bridge rail terminal connections to current standards (see Table 1130-12 of this manual for guardrail terminal replacement guidance). If an engineering analysis indicates that a section of existing guardrail is not warranted for obstacle protection or other operational factors, it may be removed. Design exceptions, in accord with Section 1100.3., shall be required when the results or determinations of the 3R design procedures require a feature improvement and the proposed project does not include that improvement.

Continuity may require that routes be analyzed as a whole with respect to lane, shoulder widths, and cross-section geometry. Apply 3R standards to individual projects, but regional policy may be required for minimum acceptable geometry on individual routes.

#### **Urban and Multilane Rural Highways**

Less is known about the safety cost-effectiveness of widening urban and multilane rural highways, and minimum values have not been proposed that highway agencies can adopt as standards. Use the minimum widths recommended for rural two-lane highways as a guide to safety cost-effective improvements for multilane rural and urban highways. However, routinely upgrading lane and shoulder widths in urban areas to the minimum widths recommended for rural two-lane highways is likely to produce some widening projects that are not safety cost-effective, particularly when there are physical constraints or high right-of-way costs. In such situations, determine the scope of widening improvements on a case-by-case basis.

#### **Gravel Surfaced Roads**

Roads in this class do not have to be analyzed for routine safety enhancement unless a prodigious accident history at specific locations warrants an improvement.

#### **Design Volume**

Determine ADT for the design life of the project. The design ADT shall equal the mid-design period ADT. Generally, design life periods for 3R projects are equal to the pavement design periods and should be compatible with the service life of the improvement.

#### **Design Speed**

The recommended minimum design speed is the 85<sup>th</sup> percentile speed. You should consider that the actual 3R improvement may increase the operating or measured 85<sup>th</sup> percentile speed over that currently posted.

On lower volume roadways, AADT less than 2,000, it may be cost prohibitive to obtain a sample size that provides a statistically valid speed study to define 85<sup>th</sup> percentile speeds for design. In these cases, the engineer should drive the project and use operating speeds observed during field investigations for the design speed, or use the safe speeds defined by existing geometrics.

Where AADT is greater than or equal to 2,000, it is likely that the Department has speed studies for the roadway on file and these should be used to estimate the 85<sup>th</sup> percentile speeds for 3R evaluation and design. If not, speed studies at these locations are usually economically feasible. Consider additional speed studies or field observations to estimate speeds in areas where there are significant accident clusters.

### **1160.3.2 Lane and Shoulder Widths**

#### **Rural Two-Lane Paved Highways**

Select lane and shoulder width improvements in accordance with a performance evaluation based on historical accident rates versus a predicted rate A. Compilation of actual accident rates and computation of a predicted accident rate A are required. Calculate the actual accident rate for the previous three- to five-year period for comparison to the predicted rate A.

If the historical accident rate is equal to or less than the predicted rate A, then the existing total lane and shoulder width may remain unchanged.

If the historical accident rate exceeds the predicted rate A, widen the total lane and shoulder width, in each direction, by 1 foot on each side for every 10 percent increment the historical accident rate exceeds A. The widening shall not exceed the values required for new construction.

Study accident data to identify accident clusters that may result from high hazard locations atypical to the route or project. You may remove the accident data from these locations for the determination of lane and shoulder widths, but analyze them on an individual basis as required by the 3R Procedure Outline shown in Figures 1160-1 and 2.

When evaluating lane and shoulder widths, consider route continuity. Adjoining projects could have a bearing on the width selection.

$$A = 0.0019 \text{ ADT}^{0.882} \times 0.879^W \times 0.919^{PA} \\ \times 0.932^{UP} \times 1.236^H \times 0.882^{TER1} \times 1.322^{TER2}$$

(Ref. Transportation Research Board Special Report 214, Appendix C)

A = number of run-off road, head-on, opposite-direction sideswipe, and same-direction sideswipe accidents per mile per year. Does not include intersection accidents

ADT = two-directional average daily traffic volume for the study period

W = existing lane width in feet

PA = existing width of paved shoulder in feet

UP = existing width of unpaved (gravel, turf, earth) shoulder, in feet

H = median roadside hazard rating for the highway segment, measured subjectively on a scale from 1 (least hazardous) to 7 (most hazardous). See Figures 1160-1 through 1160-7.

TER1 = 1 for flat terrain, 0 otherwise

TER2 = 1 for mountainous terrain, 0 otherwise

This accident model is limited because it applies only to:

- Lane widths of 8 to 12 feet and shoulder widths of 0 to 10 feet. Combinations of lane and shoulder widths that can be reasonably modeled are limited to those shown in Figure 3-2, Chapter 3 of *TRB Special Report 214*.
- Two-lane, two-way paved rural roads
- Homogeneous roadway sections. It does not include the additional accidents expected at intersections.

**Table 1160-1**  
**3R Procedure Outline (Case I)**  
**3R PROCEDURE OUTLINE**  
**CASE I**

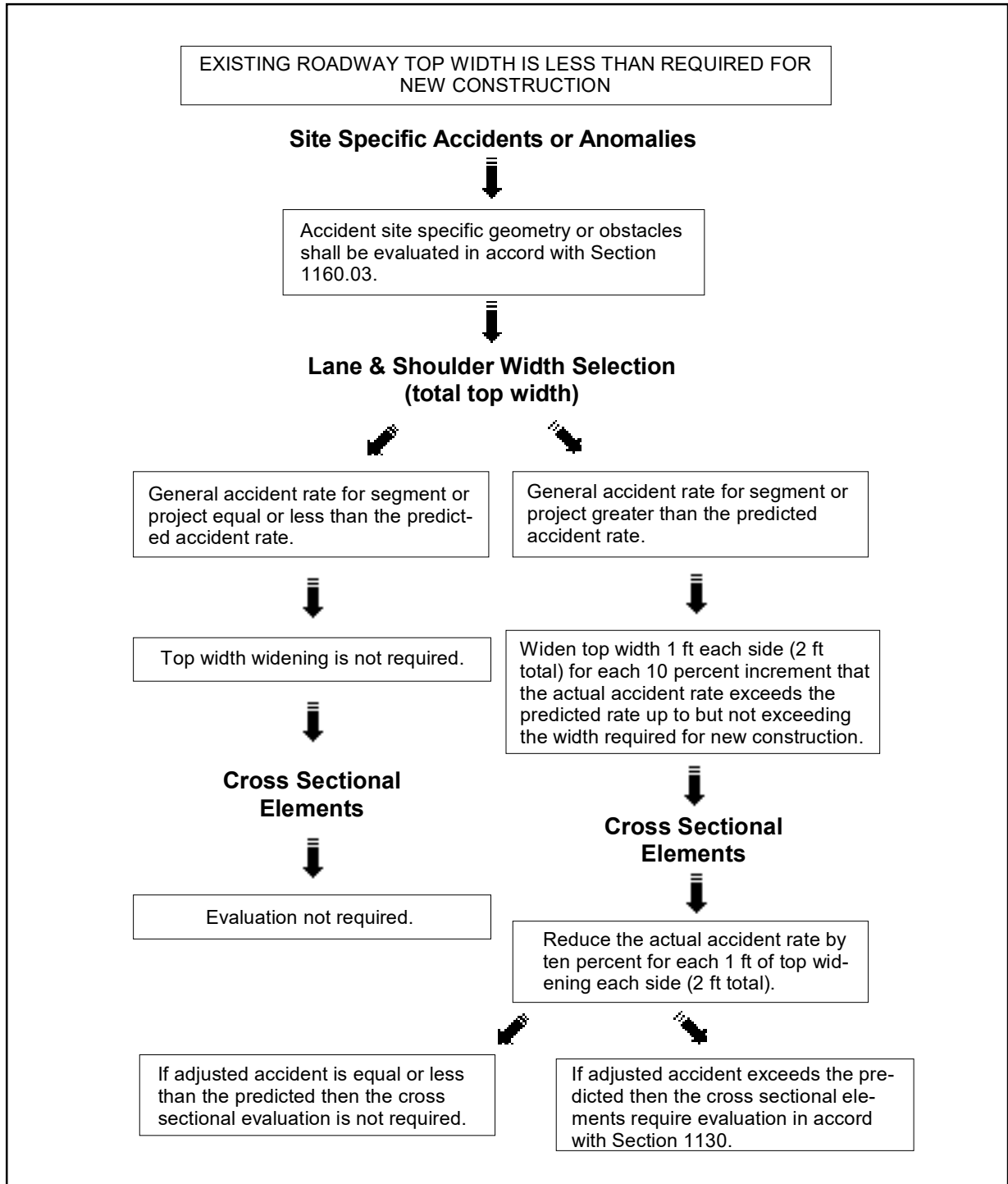
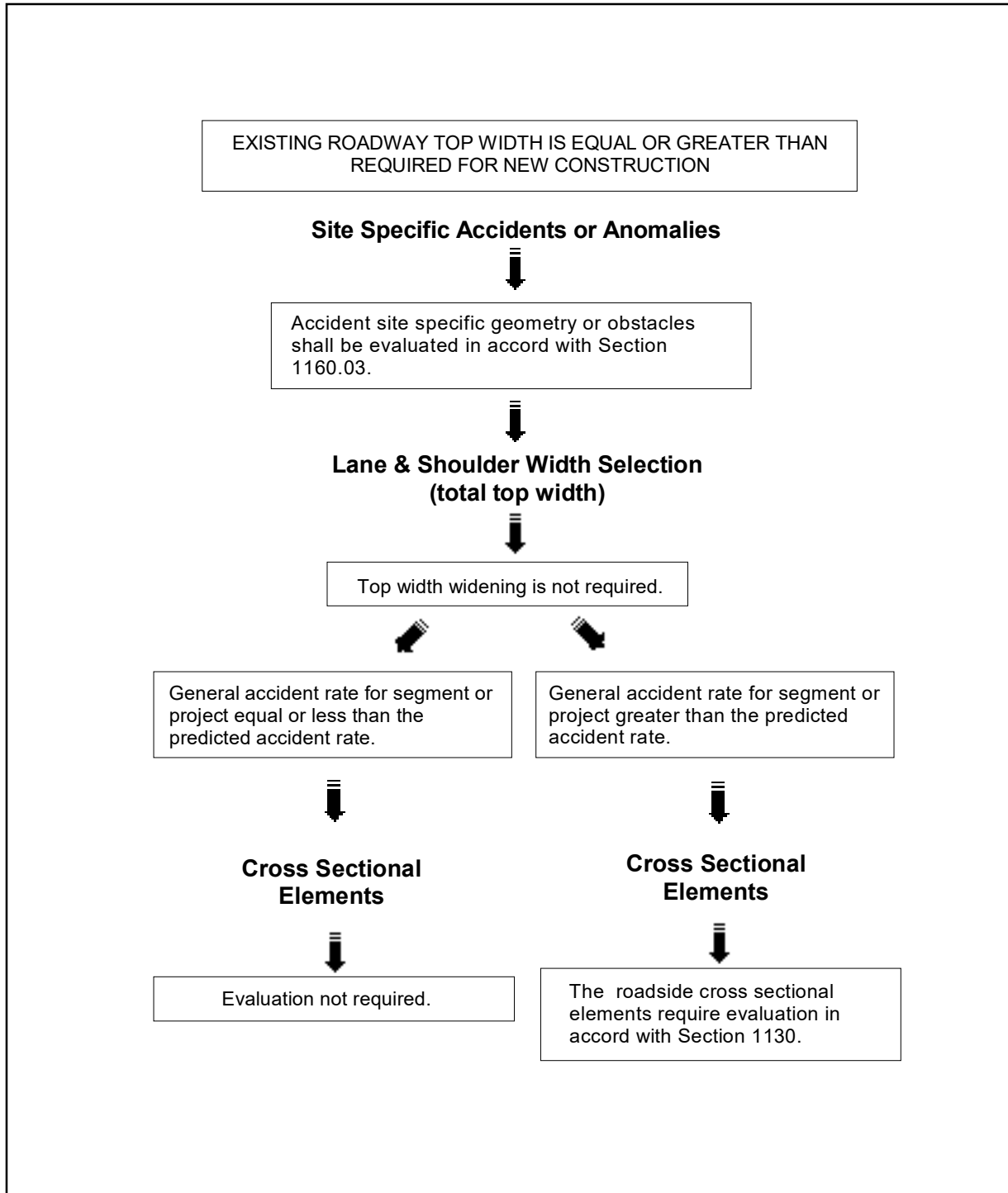
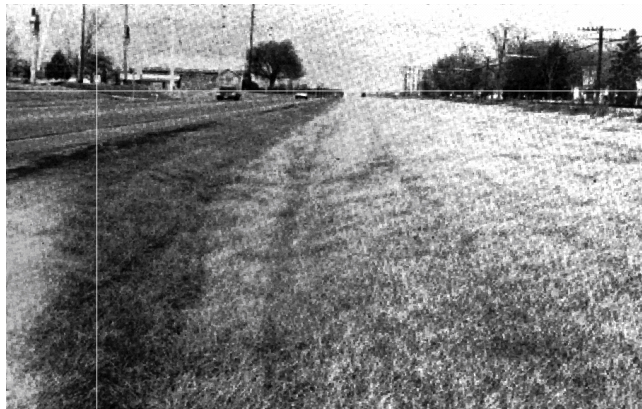
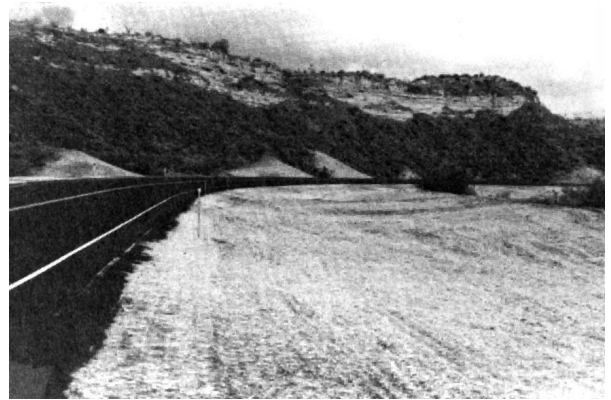
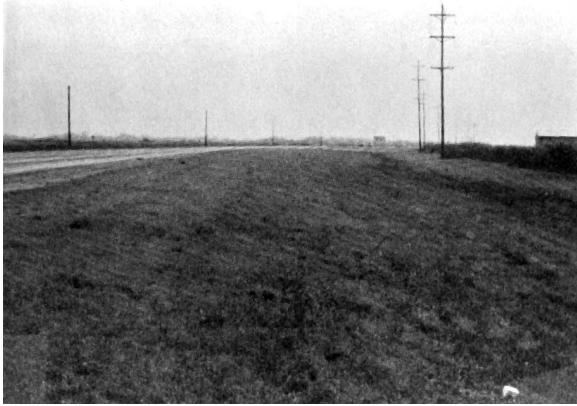


Table 1160-2  
3R Procedure Outline (Case II)

# 3R PROCEDURE OUTLINE

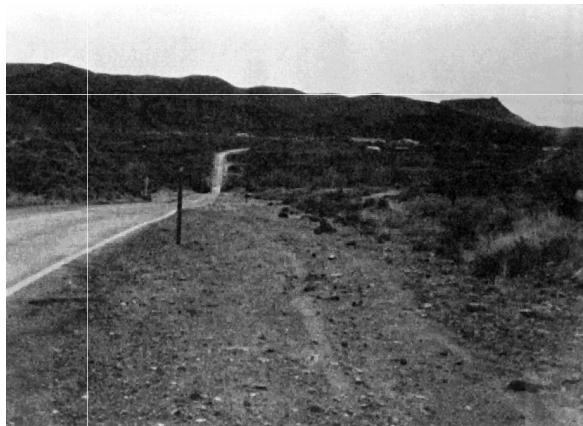
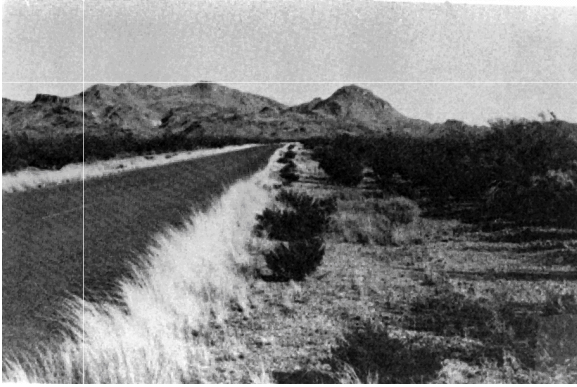
## CASE II



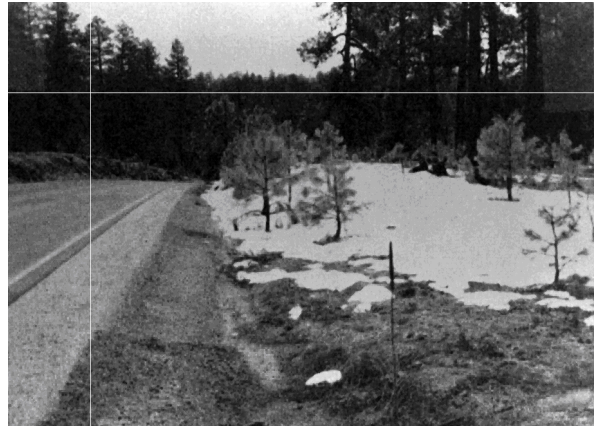


**Figure 1160-1  
Rural Roadside Hazard Rating of 1**



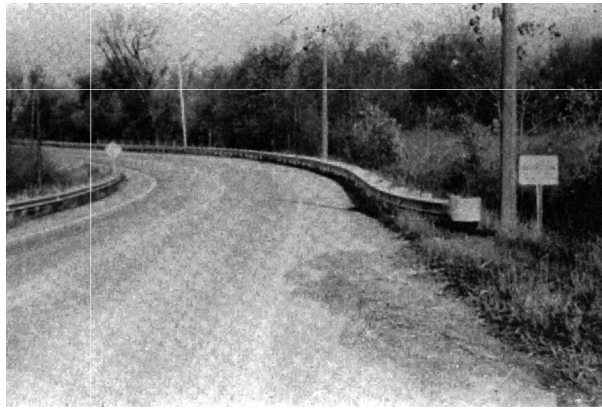
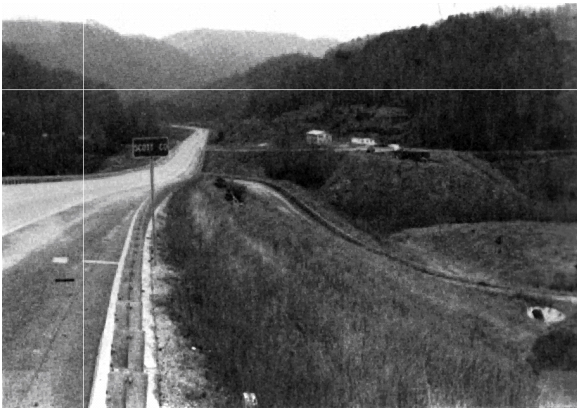


**Figure 1160-2  
Rural Roadside Hazard Rating of 2**

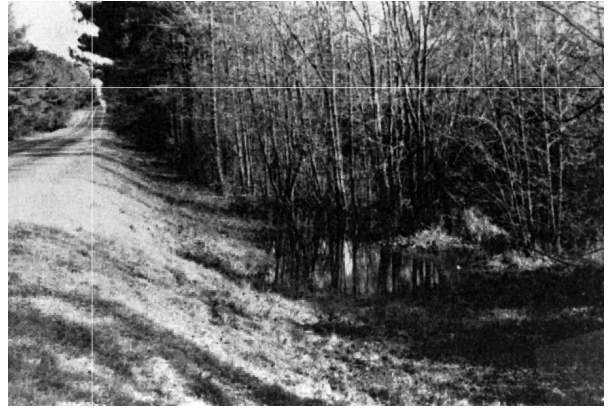


**Figure 1160-3  
Rural Roadside Hazard Rating of 3**



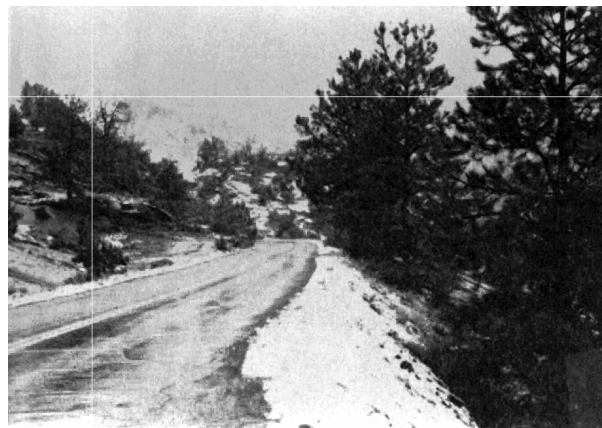
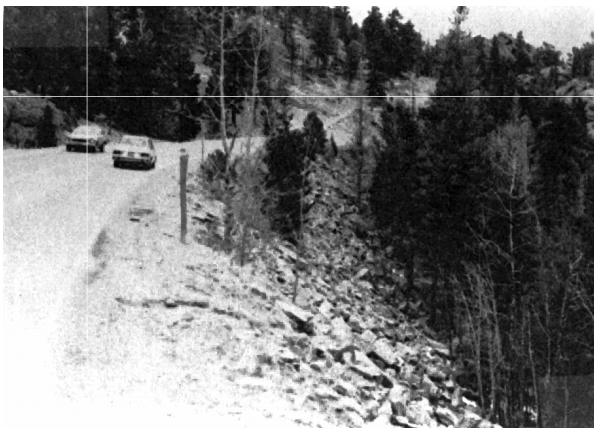
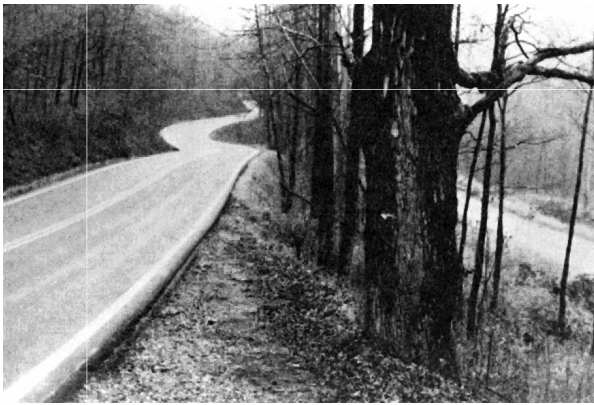


**Figure 1160-4**  
**Rural Roadside Hazard Rating of 4**



**Figure 1160-5  
Rural Roadside Hazard Rating of 5**





**Figure 1160-6**  
**Rural Roadside Hazard Rating of 6**



**Figure 1160-7  
Rural Roadside Hazard Rating of 7**

### 1160.3.3 Horizontal Curves

#### Radius of Curvature

The existing horizontal curvature may be used if superior (or equal) to the values required for new construction, or if the actual number of accidents for the previous three- to five-year period on the section of road under consideration is less than  $A_h$ . If the number of accidents is equal to or greater than  $A_h$ , improve the horizontal curvature to the standards of new construction unless it is not cost-effective. Horizontal curves that have no accident history do not require an evaluation and may remain unmodified.

$$A_h = AR_s(L)(V) + [0.0336 * D * V] \quad \text{for } L \geq L_c$$

(Ref. Transportation Research Board, Special Report 214, Appendix C)

where:

$A_h$  = predicted total number of accidents on the segment

$AR_s$  = accident rate on comparable straight segments in accidents per million vehicle miles

$L$  = length of highway segments in miles

$V$  = total traffic volume in millions of vehicles

$D$  = curvature in degrees

$L_c$  = length of curved component in miles

Consider in the cost-effective analysis the historic accident rate for the previous three- to five-year period and the related societal costs (See Example 1160-4). An annual accident cost can be calculated and compared to the annual cost of the improvement.

An annual accident cost savings should be determined as the product of the accident reduction factor (ARF) (Equation 4 in Appendix D, TRB 214; Table D-7, TRB 214; or DOT&PF's Highway Safety Improvement Program Handbook, January 25, 2002) produced by the improvement and the historic annual accident cost over the study period. The improvement is considered cost-effective if the annual accident cost savings exceeds the annual cost of the improvements.

When it is not cost-effective to improve curve alignment, consider other safety improvement measures. These improvements can consist of widening and paving shoulders, widening the clear zone, flattening steep sideslopes, removing or relocating roadside obstacles, and installing traffic control devices such as raised pavement markings or reflective guideposts.

#### Superelevation

Superelevation may remain unchanged if there are no related accidents. When accidents are related to the existing superelevation, modify it to conform to the requirements for new construction. In unusual cases, it may be possible to show by a cost-effective analysis, based on a three- to five-year accident history, that an existing cross slope may remain.

#### Superelevation Transition Length

Transition length requirements generally control driver comfort and roadway appearance rather than safety, so existing transition lengths that do not meet the requirements for new construction may remain.

#### Minimum Length of Curve

Curve length requirements generally control driver comfort and roadway appearances rather than safety, so existing curve lengths that do not meet the requirements for new construction may remain.

### 1160.3.4 Vertical Curvature and Stopping Sight Distance

#### Sag Vertical Curves

An analytical method is not available to analyze accidents at sag vertical curves. Generally, sag vertical curves that do not meet AASHTO requirements may remain. If a grouping of accidents at a sag vertical curve appears to be an anomaly when compared to similar curves, an improvement may be needed if cost-effective.

#### Crest Vertical Curves

Existing crest vertical curvature may be used if superior or equal to the values required for new construction, or if the actual number of accidents for the previous three- to five-year period on the section of road under consideration is less than  $N_c$ . If the number of actual accidents is equal to or greater than  $N_c$ , then improve the crest vertical curvature to the standards of new construction unless it can be shown not cost-effective. Vertical curves that have no actual



accident history do not require an evaluation and may remain unmodified.

$$N_c = AR_h(L_{vc})(V) + AR_h(L_r)(V)(F_{ar})$$

(Ref. Transportation Research Board, Special Report 214, Appendix C)

where:

$N_c$  = number of predicted accidents attributable to the crest vertical curve segment

$AR_h$  = average accident rate for the highway in consideration in accidents per million vehicle miles

$L_{vc}$  = length of vertical curve (highway segment) in miles

$V$  = total traffic volume in millions of vehicles

$L_r$  = length of restricted sight distance in miles (The length of restriction is the distance over which the available sight distance is less than that considered adequate by AASHTO procedures for the actual highway operating speed.)

$$L_r = \frac{[a_0 + (a_1 \times A)]}{5280}$$

$A$  = the absolute value of grade difference in percent

$F_{ar}$  = accident rate factor. See Table 1160-3 and Table 1160-4.

Equation 7 in Appendix E of TRB 214 predicts the change in accidents resulting from lengthening crest vertical curves. An annual cost savings can be estimated using the historic annual accident cost over the study period. The improvement is considered cost-effective if the annual accident cost savings exceeds the annual cost of the improvements.

### 1160.3.5 Bridges

#### Width

Improve bridge widths to the minimums established in the *AASHTO A Policy on the Geometric Design of Highways and Streets 2001* when the length is less than 100 feet and the usable width is less than the following values:

Mid Design Period ADT	Usable Bridge Width (ft) <sup>a</sup>
0-750	Width of Approach Lanes
751-2,000	Width of Approach Lanes plus 2 feet
2,001-4,000	Width of Approach Lanes plus 4 feet
Over 4,000	Width of Approach Lanes plus 6 feet

<sup>a</sup>: If lane widening is planned as part of the 3R project, the usable bridge width should be compared with the planned width of the approaches after they are widened.

You may leave qualified bridges above in place if no improvement is necessary based on a cost-effective analysis considering the previous 10-year accident history.

Bridges longer than 100 feet that are substandard in width generally are not considered for width improvement under 3R standards.

#### Structural Capacity

If any existing structural member has a design capacity less than HS 15 (HS 20 for interstate bridges), replace that member.

#### Bridge Rail and Transitions

On projects containing major bridge rehabilitation (widening, strengthening, and/or deck replacement), ensure all bridge rail and rail transitions meet strength and crash test criteria for the appropriate rail performance level. In lesser rehabilitation projects, determine by a cost-effective analysis the appropriate rail upgrade (previously discussed in this chapter). The Bridge Section will be responsible for maintaining the procedures to be used and for applying the current bridge rail upgrade guides.

#### Earthquake Capacity

All bridges on rural or urban arterials and rural or urban collectors, where there are no feasible detour routes, are essential. In addition, classify bridges as essential if they provide the only feasible access to:

- Military bases, supply depots, and National Guard installations
- Hospitals, medical supply centers, and emergency depots
- Major airports

- Defense industries and those that could easily or logically be converted to them
- Refineries, fuel storage, and distribution centers
- Major railroad terminals, railheads, docks, and truck terminals
- Major power plants, including nuclear power facilities and hydroelectric centers at major dams
- Major communication centers
- Other facilities that the state considers important from a national defense viewpoint or during emergencies resulting from natural disasters or other unforeseen circumstances

Bridges on 3R projects shall be assigned to a Seismic Performance Category in accordance with the current *AASHTO Specifications for Seismic Design of Highway Bridges*.

You do not have to investigate bridges rated SPC “A” for earthquake retrofitting.

Investigate bridges rated SPC “B,” “C,” or “D” for bearing width, bearing height, joint restraint, bearing restraint, support width, and other evident areas of potential seismic motion distress. Retrofit those structures that do not conform to the *AASHTO Specifications for Seismic Design* in the above areas in accord with the Federal Highway Administration publication FHWA-RD-94-052, *Seismic Retrofitting Manual for Highway Bridges*.

The Headquarters Bridge Section will be responsible for the retrofitting investigation. If required, the Bridge Section will also prepare retrofitting plans and specifications for inclusion in the 3R project documents.

The estimated cost of any individual bridge earthquake retrofit shall not exceed 10 percent of the estimated total structure value. If the cost exceeds 10 percent, qualify the structure for retrofitting under another funding source.

### **1160.3.6 Sideslopes and Clear Zones**

Evaluate section geometry and obstacles within the clear zone when required by the 3R Procedure Outline shown in Tables 1160-1 and 2.

### **1160.3.7 Pavement Edge Drop**

Edge drops at the edge of the traveled way are a recognized safety hazard. These drops generally occur with degradation of unpaved shoulders. Paving shoulders is the best solution for eliminating the edge drop. If shoulders won’t be paved, bring the existing shoulders to a grade with new material that matches the top edge of the driving surface.

### **1160.3.8 Intersections**

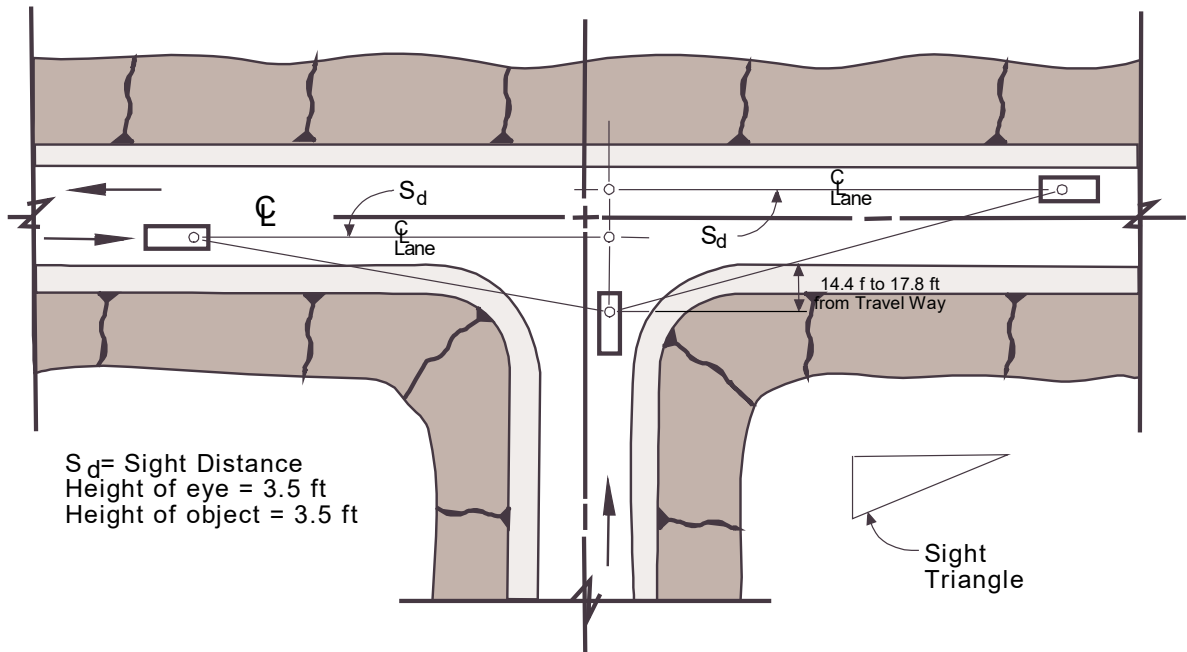
The relative risk of accidents at intersections is high. It is normal to observe accident clustering at intersections. Study the accident history of an intersection to determine if accidents are caused by a design deficiency or operator error. Correct a geometric deficiency related to accidents to the new design standards of this manual or the *AASHTO A Policy on the Geometric Design of Highways and Streets 2001*, if cost-effective or corrected by actions such as signing, signaling, or channelization.

Sight distance is of primary importance at intersections to allow operators sufficient time to observe and react to conflicts. The sight triangle shown in Figure 1160-8 is the minimum allowable at any existing intersection (driveway). The sight distances required ( $S_d$ ) are the minimum stopping sight distances required by Section 1120.1. of this manual.

### **1160.3.9 Driveways**

Existing driveway geometry may remain except if accident records indicate an anomaly. In that case, the driveway requires an engineering evaluation for improvement to meet the requirements of Section 1190 of this manual.

## MINIMUM INTERSECTION SIGHT DISTANCE



DESIGN SPEED or POSTED SPEED LIMIT mph	SD MINIMUM (ft)
20	115
25	155
30	200
35	250
40	305
45	360
50	425
55	495
60	570
65	645

Note: Minimum sight distances are stopping sight distances for level grades, between -3% and +3%. Refer to *AASHTO A Policy on Geometric Design of Highways and Streets 2001*, for desirable intersection sight distances and for grade adjustments.

**Figure 1160-8  
Minimum Intersection Sight Distance**



**Table 1160-3  
Accident Rate Factor ( $F_{ar}$ )**

Severity of sight Restriction (mph)	Degree of Hazard in Sight Restricted Area <sup>a</sup>		
	Minor	Significant	Major
0	0	0.4	1.0
5	(0.3)	(0.8)	(1.4)
10	0.5	1.1	1.8
15	1.2	2.0	2.8
20	2.0	3.0	4.0

<sup>a</sup>: See Table 1160-4

*Note:* Numbers in parentheses were interpolated from J.C. Glennon "Effects of Alignment on Highway Safety: A Synthesis of Prior Research" In TBR State of the Art Report. TRB, National Research Council, Washington D.C.

**Table 1160-4  
Relative Hazard**

Relative Hazard	Geometric condition
Minor	Tangent horizontal alignment Mild curvature (less than 3 degrees) Mild downgrade (less than 3 percent)
Significant	Low-volume intersection Intermediate curvature (3 to 6 degrees) Moderate downgrade (3 to 5 percent) Structure
Major	High-volume intersection Y-diverge on road Sharp curvature (greater than 6 degrees) Steep downgrade (greater than 5 percent) Narrow bridge Narrow pavement

**Table 1160-5  
Constants for  $L_r$**

Operating Speed on Vertical Curve (mph)	Equivalent speed to existing crest Vertical curve stopping sight distance (mph) <sup>(1)</sup>							
	60	55	50	45	40	35	30	25
	<b>Values of <math>a_0</math></b>							
60	-524	-138	-25	113	202	256	305	382
55		-452	-163	11	111	172	221	301
50			-405	-65	45	115	169	248
45				-332	-76	21	82	167
40	No sight restriction				-272	-55	15	110
35						-231	-74	51
30							-193	19
25								-130
	<b>Values of <math>a_1</math></b>							
	207.3	152.6	120.9	80.2	56.6	38.6	29.4	15.3

$$L_r = \frac{[a_0 + (a_1 \times A)]}{5280}$$

$A$  = the absolute value of grade difference in percent

(1) TRB Special Report 214 uses the definition Highway Design Speed of the existing vertical curve.

### **1160.3.10 Passing Sight Distance**

Operational and passing sight distances are given in Section 3B of the *Alaska Traffic Manual*.

Improvements of passing distances are not required within the context of 3R projects.

### **1160.3.11 Grades**

Grades that do not meet new construction standards should be evaluated as a potential contributing factor where there are clusters of accidents on or in the vicinity of the grade section. Grade-related accidents might include single or multiple vehicle accidents where a vehicle lost control and leaves the travel lane or is unable to stop. Countermeasures for steep grades may include warning signs or realignment.

### **1160.3.12 Safety Mitigation**

Even though these 3R standards may not require a geometric improvement, the designer should anticipate circumstances where mitigating improvements could be made at minimum cost. For example, geometric changes at an intersection or horizontal curve to increase sight distance may not be cost-effective, but cutting brush or trees can partially alleviate the problem.

## **1160.4. Studies**

### **1160.4.1 Design Study Report**

Prepare a Design Study Report in accord with Chapter 4, Section 450. In addition to the Section 450 requirements, include the following in the report:

- A list of all existing horizontal and crest vertical curves that do not meet the current minimum design requirements of AASHTO for new construction
- A discussion of the design speed determination in accord with Section 1160.3.3
- A discussion of the determination of lane widths in accord with Section 1160.3.4 and the clear zone requirements as determined by Section 1160.3.8
- A discussion of horizontal curve treatments in accord with Section 1160.3.5
- A discussion of vertical curve treatments in accord with Section 1160.3.6
- A discussion of bridge features that require improvement
- A discussion of accidents at intersections and what improvements may be made

Include supportive calculations for the above items in the report.

## **1160.5. Gravel to Pavement**

### **1160.5.1 General**

Section 1160.5, Gravel to Pavement, applies to non-NHS road construction projects whose primary purpose is reducing maintenance costs and improving the quality of life for Alaskans by hard surfacing of gravel roads, but which may include limited shoulder, drainage, and other work related to preserving the road structure.

The existing alignment, profile, and sideslopes may remain as long as the project does not degrade any existing safety or geometric aspects. Guardrail, guardrail terminals, and bridge rail terminal connections will not routinely be upgraded to more current standards.

### **Signing and Markings**

Inventory and evaluate all existing signing for sign placement and condition. Conform signing to the requirements of the *Alaska Traffic Manual (ATM)* and the *Alaska Sign Design Specifications (ASDS)*. Install regulatory speed limit signing conforming to the chosen design speed of the roadway. Install curve, grade, advance intersection, and other warning signs as required to warn of conditions where the safe speed is lower than the posted speed limit. Other regulatory signing requirements include stop signs at side street approaches.

Upgrade signposts that do not conform to current safety standards.

### **1160.5.2 Design Year**

The design year should at least equal the expected surface life of the selected surface type.

### **1160.5.3 Design Speed**

Use the current posted as a minimum design speed. In the absence of posted speeds, use the criteria in *A Policy for the Geometric Design of Highways and Streets 2001*, to establish a minimum design speed.

In selecting the design speed, consider the anticipated speed of traffic traveling on the newly surfaced roadway. You may use the speed limit on paved roads of similar character in selecting design speed.

#### **1160.5.4 Lane and Shoulder Widths**

##### **Rural Two-Lane Paved Highways**

Table 1160-6 shows minimum lane and shoulder width improvements.

**Table 1160-6  
Two-Lane – Two-Way Traffic  
Combined Roadway Minimum Lane & Shoulder Widths  
For Use With Gravel to Pavement Modified Procedure**

Design Year ADT 0-2000 vpd					
Minimum Lane and Shoulder Width (ft)					
Design Year Traffic Volumes (ADT) in vpd					
Design Speed (mph)	0-250	250-400	400-750	750-1500	1500-2000
20	18	20	22	22	22
30	18	20	22	22	22
45	18	22	22	22	22
50	22	22	22	22	22

### **Waiver of Roadway Width**

For roadway width less than shown in Table 1160-6, obtain a design waiver in accordance with *Alaska Preconstruction Manual* Section 1100.3. guidelines.

The minimum width for two-lane roads is 18 feet.

### **1160.5.5 Grades**

Grades do not require improvement under these standards.

### **1160.5.6 Horizontal Curves**

#### **Radius of Curvature**

No change is required under these standards.

#### **Superelevation**

Superelevation should match the design speed for the project. Follow *AASHTO A Policy on the Geometric Design of Highways and Streets 2001*. Maximum superelevation is 6 percent cross-slope.

#### **Superelevation Transition Length**

When possible, provide minimum superelevation transition length in accordance with the *AASHTO A Policy on the Geometric Design of Highways and Streets 2001*.

#### **Minimum Length**

No change is required under these standards.

### **1160.5.7 Vertical Curvature and Stopping Sight Distance**

#### **Sag and Crest Vertical Curves**

No change is required under these standards.

#### **Stopping Sight Distance**

No change is required under these standards.

#### **Intersection Sight Distance for Side Streets**

No change is required under these standards.

Consider clearing to the right-of-way limits to improve sight distance that does not meet AASHTO minimum sight distance standards.

#### **Driveway Sight Distance**

No change is required under these standards.

Consider clearing to the right-of-way limits to improve sight distance that does not meet AASHTO minimum sight distance standards.

### **1160.5.8 Bridges**

No change to the existing structure or railing is required, except as necessary to keep structures serviceable through the design period.

### **1160.5.9 Clear Zones**

No change is required under these standards.

### **1160.5.10 Bicycles**

No enhancements required.

### **1160.5.11 ADA**

Do not construct anything that will diminish the access to, or use of the facility by, a disabled person.

### **1160.5.12 Design Study Report**

For gravel to pavement projects, the requirements of Chapter 4 of this manual concerning preparation of the Design Study Report are modified to include the following:

- Structural section, addressing embankment suitability. Reference section 1180.8.
- Materials sources
- A copy of the Design Study Report to the regional maintenance director/chief

## Example 1160-1 Lane-Shoulders & X-Section

### Glacier Highway, North Lena Loop Road to Point Stephens Road

Design Period	20
Current ADT	1027
Design Year ADT	1383
Mid Period ADT	1205
Percent Trucks	6.4%
Average Running Speed	45 mph
Terrain Values	Use "0"

Existing Lanes = 11 feet and Shoulders = 0 feet

### Accident Study Period

1977 to 1987

Mid-study Period ADT 900

### Cross-Section Elements

Roadside Hazard Rating selected as 6, see Figures 1160-1 through 1160-7

$$A = 0.0019 \text{ ADT}^{0.882} \times 0.879^W \times 0.919^{PA} \times 0.932^{UP} \times 1.236^H \times 0.882^{TER1} \times 1.322^{TER2}$$

$$A = 0.0019 (900)^{0.882} \times 0.879^{11} \times 0.919^0 \times 0.932^0 \times 1.236^6 \times 0.882^0 \times 1.322^0$$

$$= 0.7 \text{ accidents /mi /year}$$

Route No. 296000

CDS mile points from Alaska DOT&PF General Road Log: 22.93 to 21.68 = 1.25 miles

See accidents for Period = 1977 through 1987 (shown on next page)

(Note: Category 7, 8, 10, 11, & 12 intersection accidents do not qualify)

**Example 1160-1  
Lane-Shoulders & X-Section, continued**

ACCNBR	ACCDTE YYMMDD	TIME	ROUTE	MI	ACC DIA	NBR VEH	TOT	MAJ INJ	MIN INJ	DAMAGE	ACC TYPE	ROAD CHAR	ROAD COND
7912635	791125 04	1630	296000	21.95	9		1				1,200	17	2
7815249	780509	1539	296000	21.72	9	1			1	800	40	4	01
8012890	801124	0640	296000	22.57	9	2				800	08	1	0
7709900	770707	1630	296000	22.14	9	1			1	2,000	25	5	01
8200598	820110	0230	296000	21.71	9	3				1,400	12	1	04
8202582	820221	1520	296000	21.75	7	3		1	3	9,000	06	1	04
8218451	821129	0750	296000	22.57	2	2				200	07	5	04
8400740	840110	0745	296000	22.55	9	1				900	29	5	05
8521909	851226	1530	296000	21.82	9	1			2	8,000	17	4	04
8606011	860422	2057	296000	21.92	9	1			1	3,000	29	4	02
8606208	860429	1426	296000	22.53	1						40	4	01
8702618	870214	2154	296000	21.71	9	1				4,000	17	1	04
8712934	871104	0825	296000	21.68	9	1					17	5	04
8715589	871216	2249	296000	21.94	9	2				600	08	5	04

**Roadway Character**

1. Straight and level
2. Straight and grade
3. Straight and hillcrest
4. Curve and level
5. Curve and grade
6. Curve and hillcrest

**Roadway Surface Condition**

1. Dry
2. Wet
3. Muddy
4. Snow/Ice
5. Slush
6. Other

**Type of Accident**

Collision With

1. Pedestrian
2. Pedacycle
3. Train
4. Animal
5. Moose

MV in Transport

6. Head on
7. Rear end
8. Angle

MV in Other Roadway

9. Head on
10. Rear end
11. Angle

Parked MV

12. Parked

Fixed Object

13. Bridge/Overpass
14. Building
15. Culvert
16. Curb/Wall
17. Ditch
18. Divider
19. Parking meter
20. Traffic light
21. Light support
22. Sign post
23. Utility post
24. Other support
25. Embankment
26. Fence
27. Guardrail
28. Machinery
29. Tree/Shrub
30. Other object
31. Aircraft

Non-Collision

40. Overturn
41. Fire/Explosion
42. Immersion
43. Gas inhalation
44. Other

Total 14 accidents, 10 accidents qualify.

$$\text{Actual} = \frac{10 \text{ acc}}{(1.25 \text{ mi} \times 10 \text{ yrs})} = 0.8 \text{ acc / mi / yr}$$

$$\left( \frac{\text{Actual}}{\text{Predicted}} - 1 \right) \times 100 = \left( \frac{0.8}{0.7} - 1 \right) \times 100 = 14.3$$

- Round 14.3 percent to the nearest 10 percent increment, or 10 percent
- The 10 percent increment requires an increased traveled way width by 2 feet.
- Clear zone need not be addressed after 4-foot widening. The widening reduces the accident rate sufficiently to preclude clear zone investigation.



## Example 1160-2 Lane-Shoulders & X-Section

### Denali Highway Rehabilitation

Design Period	10
Current ADT	100
Design Year ADT	150
Mid Period ADT	125
Percent Trucks	4.0%
Average Running Speed	50 mph
Terrain Values	"0"

Existing Lanes = 10 feet and Shoulders = 2 feet

### Accident Study Period

1975 to 1985

Mid-study Period ADT 80

Roadside Hazard Rating selected as 5, see Figures 1160-1 through 1160-7

$$A = 0.0019 (80)^{0.882} \times 0.879^{10} \times 0.919^2 \times 0.932^0 \times 1.236^5 \times 0.882^0 \times 1.322^0$$

= 0.1 accidents / mi / year

Route No. 140000

CDS mile points from Alaska DOT&PF General Road Log: 0.0 to 21.5 = 21.5 miles

See below accidents for the Period = 1975 through 1985

ACCNBR	ACCDTE YYMMDD	TIME	ROUTE	MI	ACC DIA	NBR VEH	TOT FAT	MAJ INJ	MIN INJ	DAMAGE	ACC TYPE	ROAD CHAR	ROAD COND
7712183	770722	2340	140000	5.18	9	1	1			2,000	40	4	01
8106618	810704	0901	140000	15.90	9	1				30,000	40	4	01
8106947	810712	1000	140000	21.50	1	2				4,700	07	2	03

Total 3 accidents, 2 accidents qualify (*Note: Category 7 accident does not qualify*)

$$\text{Actual} = \frac{2 \text{ acc}}{(21.5 \text{ mi} \times 10 \text{ yrs})} = 0 \text{ acc/mi/yr}$$

A > Actual Lane  $\Rightarrow$  shoulder improvements not required.

### Cross-Section Elements

Investigation not required by accident rate, see Tables 1160-1 and 2.

## Example 1160-3 Horizontal Curve

### Alaska Highway, Mile 1303 to 1285

#### Project Parameters

Project Length	17.52 miles
Design Speed (as defined in Section 1160.3.3)	60 mph
Design Period	20
ADT 1985	485
ADT 2005	750

Curve Location CDS mile 68.1 to 68.4

Curve Data  $D = 5^{\circ} - 45^{\circ}$   
 $L = 1502.07 \text{ ft}$

Accident Record for curve 10-year period 1975 to 1985, 3 recorded accidents

$$A_h = [AR_s \times L \times V] + [0.0336 \times D \times V]$$

Solve  $AR_s$

Project Length = 17.5 mi, CDS mile 62.6 to 80.1

Period: 1975 to 1985, 33 qualified accidents

(Total non-intersection accidents on straight roadway segments only)

Mid Period ADT (1980) = 300

Total Vehicle Miles = 300 ADT x 365 days x 10 yrs. x 17.5 mi. = 19.2 mvm

$$AR_s = \frac{33 \text{ accidents}}{19.2 \text{ mvm}} = 1.7 \frac{\text{acc}}{\text{mvm}}$$

$V = 300 \text{ ADT} \times 365 \text{ days} \times 10 \text{ yrs.} = 1,095,000 \text{ vehicles}$

$$A_h = [1.7 \text{ acc/mvm} \times 0.3 \text{ mi} \times 1.095 \text{ Milveh}] + [0.0336 \times 5.75^{\circ} \times 1.095 \text{ Milveh}] = 0.8 \text{ accidents}$$

Actual accidents (3) exceeds predicted  $A_h$  ( $3 > 0.8$ )

Therefore, improve curve to new construction minimums or check with cost-effective analysis  
See following Example 1160-4.

## Example 1160-4 Cost-Effective Analysis

### Horizontal Curve; See Previous Example 1160-3

**Given:** Typical cut section

Shoulder	6 feet from new typical section
Cut height	50 feet
Horizontal line shift to accommodate new alignment	100 ft
Excavation cost	\$3 per yd <sup>3</sup>

First cost:      Curve length = 1502.07 ft from previous example 1160-3

Excavation EFC =  $[1502.07 \times 50' \times 100'] / [2 \times 27] \times \$3.00 = \$417,242$

CRF = Capital Recovery Factor, to compare present cost of multi-year cost of improvement

$$CRF = \frac{(1.07)^{20} \times 0.07}{(1.07)^{20} - 1} = 0.0944$$

Annual First Cost =  $0.0944 \times \$417,242 = \$39,388$  per yr.

Accident cost:

ACCNBR	ACCDTE YYMMDD	TIME	ROUTE	MI	ACC DIA	NBR VEH	TOT FAT	MAJ INJ	MIN INJ	DAMAGE	ACC TYPE	ROAD CHAR	ROAD COND
7910447	791203	1345	180000	68.25	9	2	1			25,000	06	x	x
8012908	801115	1630	180000	68.25	9	1				3,000	40	5	04
7811753	781002	1145	180000	68.25	9	1		1		800	17	6	04

Fatality	1												
Major injury	0												
Property Damage	3		\$25,000 + \$3,000 + \$800	=			\$28,800						
Total accident cost				=			\$2,628,800						

10-year period (from Example 1160-3)

Annual accident cost =  $\$2,628,800 / 10 = \$262,800$

Annual accident cost greater than annual first cost of improvement; therefore, the curve geometry should be changed.

### Discussion

There is the question of whether the fatality was an anomaly. Was high speed involved, an object in the traveled way, or some other factor not related to the curvature? In this case, two vehicles were involved, and it is possible that the accident cause was unrelated to the curvature. If the fatality was an anomaly, then it may be reasonable to only consider the remaining accidents. In that case, the annual accident cost would be \$380  $([\$3,000 + \$800] / 10)$ , and the curve would not require improvement.

## Example 1160-5 Vertical Curve

### Unknown Highway, Mile 31 to 44

#### Project Parameters

Project Length = 13.8 miles, CDS mile 31 to 44.8  
Design Speed (as defined in Section 11603.3) = 50 mph  
Design Period = 20  
ADT 1990      804  
ADT 2010      981  
Sight Distance = 475 ft (See AASHTO Policy on Design)

Curve Location              CDS mile 31.6 to 31.7.

Curve Data               $g_1 = 2.00\%$   
                                  $g_2 = -3.00\%$   
                                 Length = 500.00 ft

#### Existing Sight Distance

Select the following value for “S” which meets the stated relationship of “S” to “L.”

$S > L$

$$S = \frac{1}{2} \left( L + \frac{1329}{A} \right) = \frac{1}{2} \left( 500' + \frac{1329}{5} \right) = 383 \text{ ft} \quad \text{Not OK; less than “L”}$$

$S < L$

$$S = \left( \frac{1329 \times L}{A} \right)^{\frac{1}{2}} = \left( \frac{1329 \times 500}{5} \right)^{\frac{1}{2}} = 364 \text{ ft} \quad \text{OK; less than “L”}$$

Existing sight distance = 364 ft and is substandard to the required 475 ft.

See Section 1160.3.6, Vertical Curvature and Stopping Sight Distance.

Accident Record for curve      10-year period 1978 to 1987, three recorded accidents

Mid Period ADT(1983) = 600

$N_c = [AR_h \times L_{vc} \times V] + AR_h (L_r)(V)(F_{ar})$  See 1160.3.6a, Sag Vertical Curves

#### Determine $AR_h$

Project Length = 13.80 mi, CDS mileage 31 to 44.8

Period: 1978 to 1987, 27 qualified non-intersection accidents

Mid Period ADT (1983) = 600

(continued on next page)

**Example 1160-5**  
**Vertical Curve, continued**

Total vehicle miles = (600 ADT x 365 days x 10 yrs x 13.8 mi)/1,000,000 = 30.2 mvm

$$AR_h = \frac{27 \text{ accidents}}{30.2 \text{ mvm}} = 0.9 \frac{\text{acc}}{\text{mvm}}$$

**Solve for L<sub>r</sub>**

Equivalent speed to existing crest vertical curve stopping sight distance of 364 ft = 45 mph (nearest 5 mph) from Table 1160-5, value for a<sub>o</sub>

From Table 1160-5, using a design speed of 45 mph

$$a_o = -65$$

$$a_i = 80.2$$

$$L_r = (a_o + (a_i \times A)) \left( \frac{1}{5280} \right) = (-65 + (80.2 \times 5)) \left( \frac{1}{5280} \right) = 0.064 \text{ miles}$$

**Find F<sub>ar</sub>**

From Tables 1160-3 and 4

$$F_{ar} = 0.8$$

Severity of sight restriction = (50 mph)-(45 mph) = 5 mph

Moderate down grade @ -3% = significant

**Find Vertical Curve Volume**

V = (600 ADT x 365 days x 10 yrs)/1,000,000 = 2.190 mv

Solve N (Number of accidents for ten year period in question.)

$$N_c = [AR_h \times L_{vc} \times V] + AR_h (L_r)(V)(F_{ar})$$

$$N_c = \left[ 0.9 \frac{\text{acc}}{\text{mvm}} \times \frac{500'}{5280 \frac{\text{ft}}{\text{mi}}} \times 2.19 \text{mv} \right] + 0.9 \frac{\text{acc}}{\text{mvm}} (0.064 \text{ mi})(2.19 \text{mv})(0.8) = 0.29 \text{ acc}$$

Actual accidents (3) exceeds predicted N<sub>c</sub>

Therefore, improve curve to appropriate minimums or check with cost-effective analysis.

## 1170. Special Design Elements

---

- 1170.1. Roadway Illumination
- 1170.2. Bus Stops
- 1170.3. Bus and HOV Lane
- 1170.4. Boardwalks
- 1170.5. Boat Ramps
- 1170.6. Airway-Highway Clearances
- 1170.7. Highway Signs, Luminaires, Traffic Signals, Poles, and Posts
- 1170.8. Fencing

### 1170.1. Roadway Illumination

Select and design new lighting systems in conformance with the criteria in the 1984 AASHTO publication *An Informational Guide for Roadway Lighting* (IGRL), and the following:

1. Do not exceed the allowable veiling luminance ratio, as shown in Table 2 of the IGRL. This applies when using either the Luminance or Illuminance design method.
2. The Luminance design method (as described in the IGRL) is preferred over the Illuminance method because it typically results in systems that are more economical to construct and maintain.
3. Use cutoff or full cutoff luminaires where feasible.
4. Avoid staggered light pole arrangements where feasible.
5. “Small Target Visibility” results (as defined in ANSI/IES RP-8-00, “Roadway Lighting,” 2000) may be used as a tiebreaker when choosing between systems that otherwise perform similarly.

### 1170.2. Bus Stops

Bus transit is an integral part of the operation of many urban streets and highways. Consider the existing operating policies and the future transit needs of communities where applicable, particularly where bus movements caused by bus stops will affect intersection capacity. Normally, locate bus stops on the far corner of intersections to free the approach shoulder lane for right-turning vehicles.

Consider other transit facilities for buses, such as bus passenger shelters, park-and-ride lots, and turnouts (separate loading zone). Base the decision to include bus turnouts on the volume and turning movements of

both the bus traffic and through traffic, the distance between bus stops, and right-of-way limitations. Base the design features for turnouts on the size and turning radius of the bus. Generally, radii allow buses to remain in the outer lane during the full turn. For ADA access considerations, also see Americans with Disabilities Act Accessibility Guidelines.

### 1170.3. Bus and HOV (High Occupancy Vehicle) Lane

Include special lanes for buses and HOVs on projects only where such an auxiliary lane is part of an integrated network for buses and/or HOVs. Typically, these lanes are shoulder lanes of sufficient width to accommodate the wider buses. A normal bus/HOV lane is 12 to 14 feet wide, with no additional shoulder provisions.

Bus/HOV lanes should be to the right of normal traffic. This makes the shoulder lane available during off-peak hours for disabled and right-turning vehicles.

### 1170.4. Boardwalks

Water, sewer, and solid waste conveyance systems in rural Alaska are not always feasible without great expense due to permafrost and other natural constraints. As an alternative, water may have to be delivered to each home from a community well and sewage collected and hauled to a sewage lagoon. It may be necessary to transport solid waste to a community dumpsite.

It is common practice to handle most of this transport with four-wheel, all-terrain vehicles (ATVs) pulling trailers loaded with tanks. Sizes of vehicles and tanks vary depending on the size of the community. Other transportation systems may be necessary to provide maintenance access.

The construction and maintenance of roads are sometimes extremely expensive due to natural constraints and the lack of locally available materials. An economical alternative to a road is a drivable boardwalk. For ADA access considerations, see Section 1310.

Consider the following in design for a drivable boardwalk:

1. Designate design speed as 5 mph or as recommended by the regional traffic engineer.

2. Use as the minimum design vehicle a four-wheel, all-terrain vehicle pulling a two-wheel trailer with an 80-gallon tank, with a design load of up to 700 pounds per wheel.
3. Use as design width a minimum of 8 feet including wheel rails (See Figures 1170-1a and 1b).
4. Design and specify horizontal and vertical geometry, if required, on a per project basis.
5. Design turnouts, if required, to accommodate the design vehicle.
6. Ensure the boardwalk design meets the Americans with Disabilities Act guidelines.
7. You may require an anchoring system in areas that are subject to seasonal flooding.
8. Boardwalks installed in or near tidal areas may need to be built on pilings to avoid flooding during extreme high tides.
9. Space surface planks  $\frac{3}{4}$  inch apart to enable drainage.
10. Install wheel guards as required. Wheel guards are not required at access points.
11. If you anticipate pedestrian use, you may need handrails for elevated sections.
12. Ensure timber treatment complies with the Clean Water Act.

Figure 1170-1a is a cross-sectional view of a minimum design boardwalk. The loading is 700 pounds per wheel. All dimensions for lumber are nominal.

## **1170.5. Boat Ramps**

### **1170.5.1. General**

This section describes basic criteria for the design of boat ramps. However, the final design will involve many other engineering factors to provide a safe, efficient facility. Grades, alignment, and surface materials are probably the most important factors.

### **1170.5.2. Grades**

Boat ramp grades should be greater than 10 percent and less than 13 percent. Flatter ramps require backing the motorized towing vehicle too far into the water before the boat floats free of the trailer. Steeper grades make it difficult to pull the loaded trailer up the ramp. A 12 percent grade is desirable.

### **1170.5.3. Alignment**

If possible, design the ramp and approaches so that the combination of towing and towed vehicles lines up directly down the ramp. Avoid turning movements while backing if possible.

### **1170.5.4. Surface**

Use concrete planks from just above the highest high-water line to a point sufficiently below the mean low-water line to permit unloading a boat without the trailer wheels leaving the planking, even at mean lower low-water. The ramp above the planking should be firm and have a surface that provides adequate traction to the towing vehicle when pulling a loaded trailer from the water.

### **1170.5.5. Other Considerations**

Wherever you construct a boat ramp, provide sufficient areas for parking, including for boat trailers. Provide piers or floats adjacent to the ramp for access to the boat after flotation. You may also want lavatories and picnic tables in the area.

## **1170.6. Airway-Highway Clearances**

Whenever a highway project will involve construction or operations within 1.74 nautical miles (2 miles) of an airport, airstrip, heliport, or other aircraft facility, be aware of the airspace navigational requirements of the aircraft facility. The *FHWA Federal-Aid Program Manual Volume 6*, Chapter 1, Subchapter 2.4(c) states:

*“Federal funds shall not participate in projects where substandard (airway) clearances are created or will continue to exist.”*

Part 77, Federal Aviation Regulations, sets forth aircraft facility clearances, including horizontal and vertical “nonintrusion” zones. Conform to these FAA regulations whenever any of the following conditions exist:

1. The project is near an FAA-recognized or FAA-controlled aircraft facility
2. The project involves a federal-aid route
3. The project is federally funded in whole or in part

On air strips and other non-FAA facilities, conform to the federal regulations or document justification for noncompliance. Furnish a copy of the documentation to the commissioner.

## **1170.7. Highway Signs, Luminaires Traffic Signals, Poles, and Posts**

### **1170.7.1. General**

Sign, electroliner, and signal design must conform to the requirements of the *Alaska Traffic Manual*.

Design highway lighting structures under 60 feet in height and traffic signals to conform to the 1994 edition of *AASHTO Standard Specifications for Structural Supports for Highway Signs, Luminaires, and Traffic Signals*.

Design high tower lighting systems (60 feet and over in height) to conform to the 2001 edition of *AASHTO Standard Specifications for Structural Supports for Highway Signs, Luminaires, and Traffic Signals*.

### **1170.7.2. Sign Supports**

Design sign post supports in accordance with Figures 1170-2 through 1170-12.

Place all new roadside signs and luminaires on breakaway supports on high-speed highways located within the clear zone width, unless you locate them behind a barrier or crash cushion that is necessary for other reasons. Supports outside this suggested clear zone should preferably be breakaway where there is a probability of being struck by errant vehicles.

Replace all existing sign supports that do not comply with NCHRP 350 crashworthiness standards. This includes all perforated steel tube sign supports larger than 2 inches on a side that are located within 7 feet of each other.

### **1170.7.3. Breakaway Supports**

The design of breakaway support mechanisms allows them to function properly when loaded primarily in shear. The design of most mechanisms allows them to be hit at bumper height, typically about 20 inches above the ground. If hit at a significantly higher point, the bending moment in the breakaway base may be sufficient to bind the breakaway device. For this reason, do not put breakaway supports near ditches or on steep slopes, or at similar locations where a vehicle is likely to be partially airborne at the time of impact.

### **1170.7.4. Large Roadside Signs**

Large roadside signs are greater than 500 square feet. They typically have two or more breakaway support posts. To achieve satisfactory breakaway performance, they should meet the following criteria (see Figure 1170-12):

- Place a hinge at least 7 feet above the ground so no portion of the sign or upper section of the support is likely to penetrate the windshield of an impacting vehicle (see Standard Drawing S-34, Fuse Plate Details).
- A single post, if 7 feet or more from another post, or all posts within a 7-foot path, should weigh less than 45 lbs/ft. The total weight below the hinge, but above the shear plate of the breakaway base, should be less than 600 pounds.
- Do not attach supplementary signs below the hinges if such placement is likely to interfere with the breakaway action of the support post or if the supplemental sign is likely to strike the windshield of an impacting vehicle.

### **1170.7.5. Small Roadside Signs**

Small roadside signs are those supported on one or more posts and having a sign panel area less than 50 square feet. Small sign supports are driven directly into the soil, set in drilled holes, or mounted on a separately installed base.

The breakaway mechanisms of small signs supports consist of a base bending fracture or breakaway coupling design (see slip base details on Standard Drawing S-34.00). The bottom of a small sign panel should be a minimum of 7 feet above the ground and the top of the panel a minimum of 9 feet above the ground to minimize the possibility of the sign panel and post rotating on impact and striking the windshield of a vehicle.

Fracturing sign supports are wood or steel posts, or steel pipes connected at ground level to a separate anchor. Wood posts are typically set in drilled holes and backfilled, while anchors for steel pipe or post systems are driven into the ground (see Standard Drawing S-30.03).

You may provide unidirectional slip bases for small sign support posts (see Standard Drawing S-34.00). The inclined design shown on Standard Drawing S-34.00 ensures the sign will move upward to allow the impacting vehicle to pass under without the sign hitting the windshield or top of the car. When you use this type of slip base for small signs, you do not need hinges in the post.

The major limitation of the inclined slip base is its directional property. The inclined slip base can only



be struck from one direction to yield satisfactorily and should not be used in medians or traffic islands or other locations where hits from several directions are likely. Multi-directional slip bases are typically triangular and are designed to release when struck from any direction. These types of breakaway supports are ideally suited for use on medians, channelizing islands, ramp terminals, and other locations where a sign may be hit from several directions.

#### **1170.7.6. Multiple Post Supports for Sign Supports**

Consider all breakaway supports within a 7-foot width in multiple post sign structures as acting together. This 7-foot criterion is based on a need to minimize the potential for unacceptable performance of breakaway hardware. In some cases, a vehicle could leave the roadway at a sufficiently high angle that it would hit two posts within a 7-foot path. In other cases, a vehicle could yaw in the roadside to such an extent that it would strike two posts within a 7-foot path. In many instances, the greatest change in vehicle velocity occurs when hitting breakaway hardware at slower speeds because less energy is available to activate the breakaway mechanism. Since vehicles leaving the roadway at very high angles or yawing vehicles would likely be traveling at slower speeds, the 7-foot criterion is a reasonable safety factor that you should use in roadside design of breakaway hardware.

#### **1170.7.7. Signal Poles**

Signal poles are obstacles. The mastarm loading overturning moment (due to equipment positioning) and wind loads require substantial poles with fixed bases and foundations.

Section 1130.2.2, Low Speed Roadways, and AASHTO 2001 A Policy on the Geometric Design of Highways and Streets allow 18 inches of clear zones in low-speed urban areas with curbs because of the expense of obtaining full clear zones (e.g. Table 1130-2) in urban areas. As such, signal pole location in low-speed urban areas is rarely an issue.

Where signalization is required for intersection control on high-speed roadways (>45 mph) or in rural areas, place signal poles outside of the clear zone where practical. However, offset location of the pole is constrained by the need to position mastarm equipment over lanes, and because mastarm length is limited to 60 feet. Removal or relocation of the signal

pole outside of the clear zone may not be an option. The design loads prohibit breakaway supports, so the only obstacle treatment options are to shield the poles with crash cushions or barriers, or to provide obstacle delineation.

Evaluate signal poles in high-speed, rural locations for cost-effectiveness to determine if a barrier should be installed, or if a pole can stand without treatment (the signals on the structure should provide adequate delineation). Use the procedures and methods in 1130.6 of this manual to complete a cost-effective analysis and determine the appropriate treatment for signal poles located inside the clear zone at high-speed locations.

### **1170.8. Fencing**

#### **1170.8.1. Introduction**

Fencing may be required or desirable on some highway projects. The need for fencing can be identified during planning, scoping, environmental document, design, ROW, or construction phases of a project.

This section covers permanent fence installation. Temporary installations, such as during construction, are not covered in this Section.

#### **1170.8.2. Functions**

Fencing serves a number of purposes including:

1. Barrier to human and wildlife encroachment
2. Safety
3. Property boundary delineation
4. Security
5. Channelization
6. Privacy
7. Noise reduction
8. Snow drift abatement

Fences may, and often do, serve multiple purposes.

#### **1170.8.3. Types**

The Department normally uses the following types of fence:

- Chain link
- Woven wire
- Barbed wire

- Decorative

The *Standard Specifications for Highway Construction* – Sec. 607 - covers construction of chain link, woven wire and barbed wire fences. The *Alaska Standard Drawings Manual* contains standard plans and details for these types of fences.

#### **1170.8.4. Design Considerations**

Install fence consistent with the clear zone concept outlined in Section 1130.2.3 of this manual. Avoid installing fence in drainage collection areas.

#### **Barrier Fence**

Barrier fence provides maximum protection against ROW encroachments by pedestrians, bicyclists, wildlife and other motorized vehicles such as snow machines and ATVs.

Consider barrier fence:

- Along fully or partially access controlled highways
- Between freeways or expressways and adjacent frontage roads or business districts
- Near schools, colleges, playgrounds, parks and athletic fields
- Where existing streets dead end at a freeway controlled access line
- In industrial areas or large residential developments
- Adjacent to military reservations
- At other locations where a barrier is needed to protect against vehicular, pedestrian, bicycle, or wildlife encroachment.

Barrier fence is generally installed parallel to centerline and on, or just inside, the ROW line or access control line. Fencing on a continuous alignment usually has a pleasing appearance and is the most economical to construct and maintain.

#### **Safety Fence**

Safety fence is installed:

- To protect users of sidewalks and paths located within the ROW from hazards adjacent to or near these transportation features

- To protect the general public and maintenance workers from other readily accessible hazards within the ROW
- To protect adjacent private property from hazards at or near the ROW line

Consider safety fence when:

1. Vertical drop offs equal, or exceed 4 feet
2. Side slope and slope height is steeper than 2H:1V and greater than 8 feet, respectively
3. Permanent bodies of water over 3 feet deep or swift flowing water are present
4. Children or mobility impaired persons are present in significant numbers near the hazard(s)

Other factors such as proximity and likelihood of exposure to hazard from paths and sidewalks, and severity of hazard need consideration. When deciding the necessity for safety fence, engineering judgment should prevail.

Install 4 foot high, minimum, safety fence. In some circumstances, safety rail will serve the same function as safety fence. Safety rail is not part of this Section.

#### **Property Boundary Delineation**

Fencing can delineate property boundaries, but this purpose is usually secondary to a primary function such as a barrier or safety fence.

#### **Security Fence**

Security fence is commonly used on or adjacent to military reservations.

#### **Channelization Fence**

Channelization fence is commonly used for directing and funneling pedestrians or wildlife to, or away from, specific locations or structures. In the case of wildlife, this could be an at-grade crossing or an underpass structure.

#### **Privacy Fence**

Privacy fence is used for visual screening. Materials, geometry and alignment are selected to meet the location-specific terrain, vistas and aesthetics.

Plastic coated chain link with vinyl slats, available in a variety of colors, is a cost-effective privacy fence.

Custom privacy fence may be used in special cases where the context of the physical and human

environmental dictates it, or when stipulated in ROW agreements.

### **Noise Fence**

Refer to the Alaska DOT&PF Alaska Environmental Procedures Manual Noise Policy for guidance on when to consider installing noise fence.

<http://www.dot.state.ak.us/stwddes/desenviron/resources/noise.shtml>

Select alignment, geometry and material for the target level of noise reduction.

### **Snow Drift Abatement Fence**

Consider the use of snow fence where blowing and drifting snow can inhibit maintenance and operations. Also consider fencing where snow removal operations could cause private property damage.

#### **1170.8.5. Other Considerations**

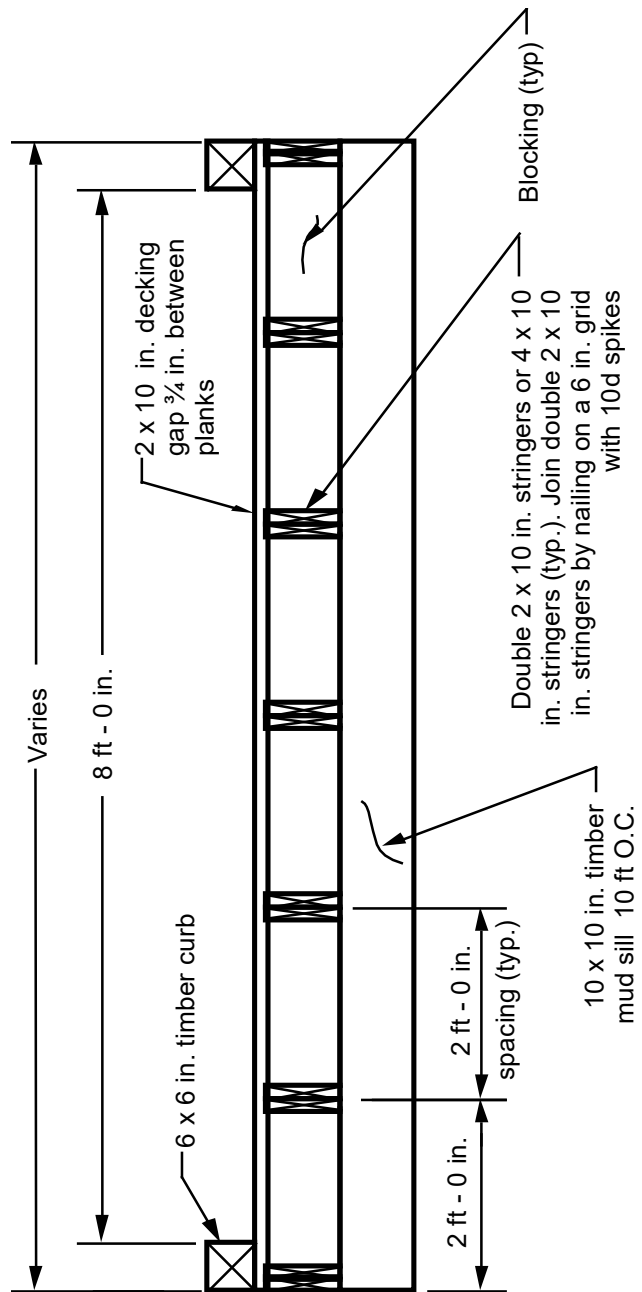
Except where warranted for highway applications, fencing is normally the responsibility of the abutting property owner. Existing private fences within the State ROW are considered encroachments that property owners must remove it at their own expense.

If a request by a private property owner, public agency or local government is made for additional fencing during construction, field personnel should confer with Design on its merits. If warranted, provide documentation justifying the need in the change order.

Metallic fencing can interfere with airport traffic control radar. When locating fencing in the vicinity of an airport, contact the Federal Aviation Administration to determine whether metal fence will create radar interference at the airport. If so, use non-metallic fencing.

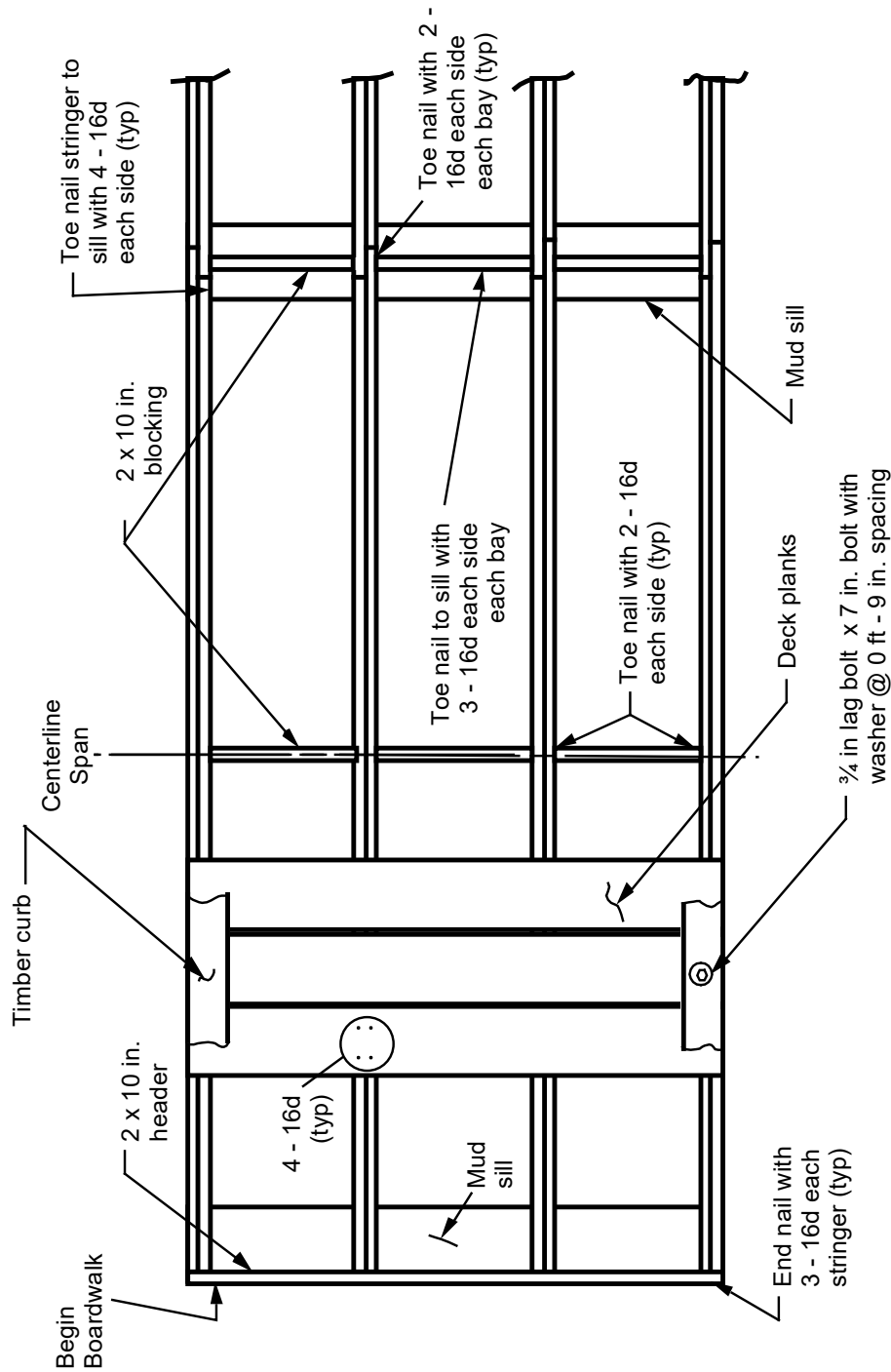
#### **1170.8.6. References**

1. AASHTO - *An Informational Guide on Fencing Controlled Access Highways* - 3<sup>rd</sup> Edition  
November 1990.



**TYPICAL SECTION**

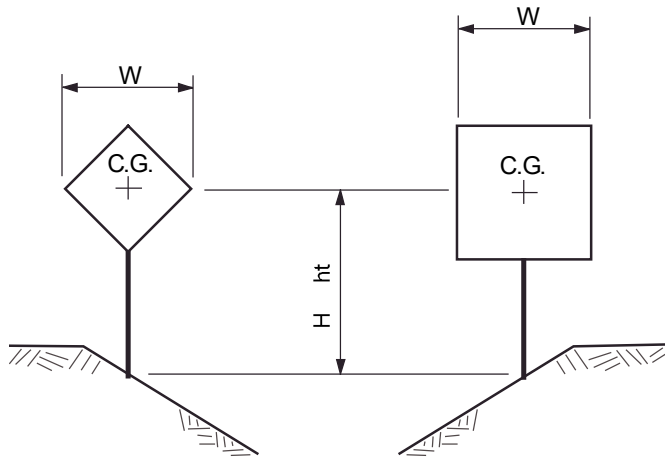
**Figure 1170-1a**  
**Boardwalk**  
(Designed for minimum loading)



**FRAMING PLAN**

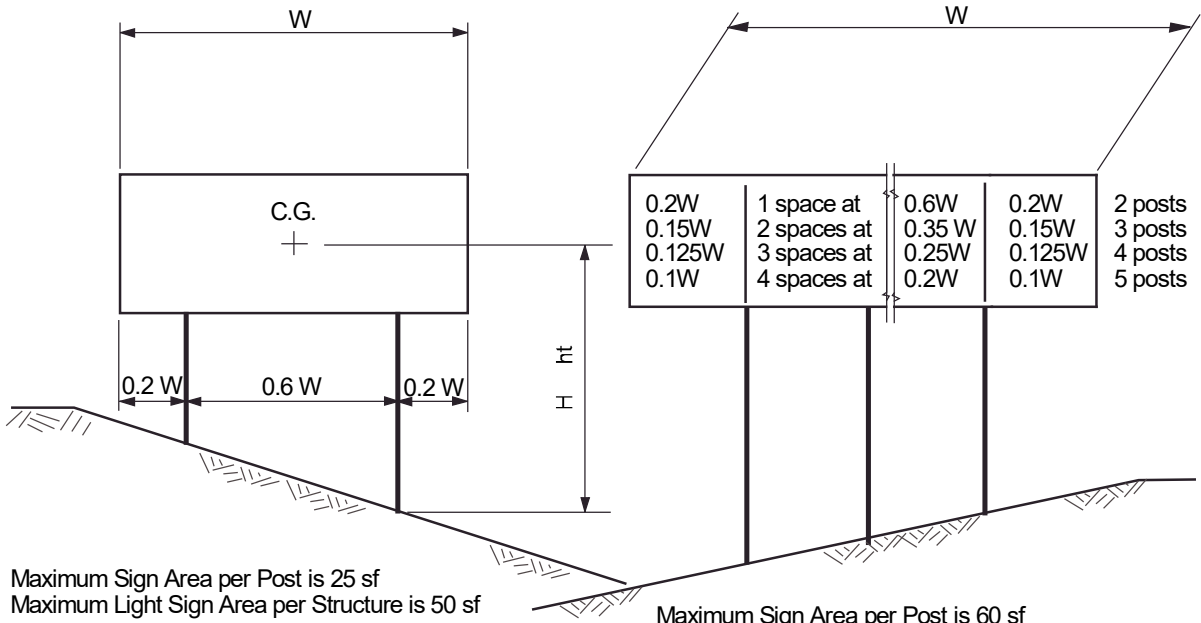
**Figure 1170-1b  
Boardwalk  
(Designed for minimum loading)**

# SIGN POST DESIGN SPECIFICATIONS



## GENERAL NOTES for SIGN POST SELECTION

1. Design based on the following Post Material: Steel conformed to the requirements of ASTM A501 for Steel Tubing, ASTM A53 for Steel Pipe standard weight, ASTM 36 for W Shape Beams, and ASTM 446 for Perforated Tubing. Sawn Wood Post material shall conform to AASHTO M 168.
2. Solid lines on Figure 1170-5 through 1170-10 indicate maximum use of the indicated post. Any combined value of sign area and height to the right or above the solid line indicates the use of the next larger post.
3. Fracture posts or slip bases shall be used for all Posts in the clear zone.
4. Designer should determine the type of sign support by the following: Wind velocities expected in the project area, location of sign in sheltered or exposed areas, temporary or permanent type sign, expected life of sign, maintenance cost in relation to construction cost.



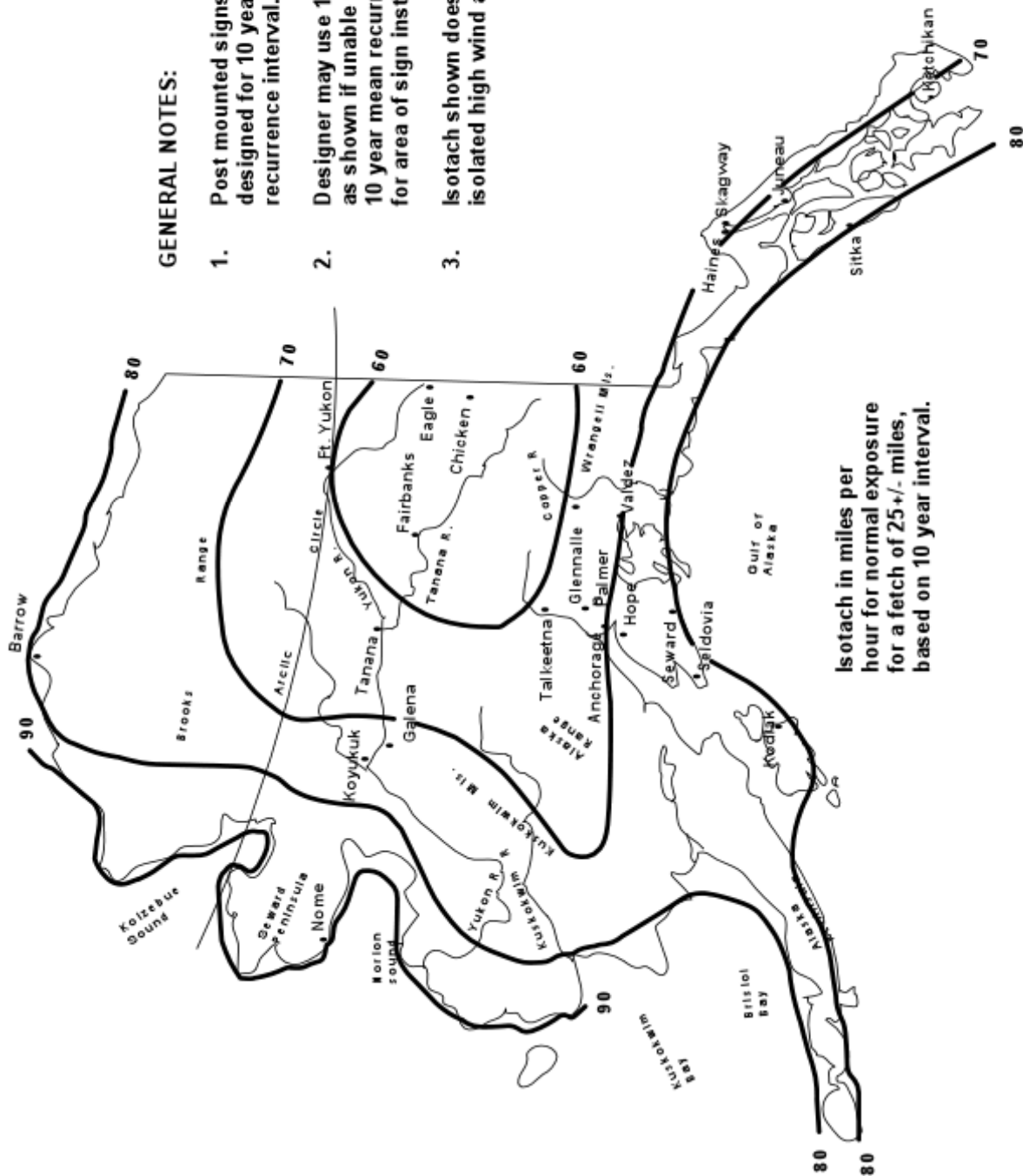
Maximum Sign Area per Post is 25 sf  
 Maximum Light Sign Area per Structure is 50 sf

Maximum Sign Area per Post is 60 sf  
 Heavy Structured Signs may require framing.  
 See Standard Drawing S.00.00.

### LIGHT SIGN STRUCTURES < 50 sf

### HEAVY SIGN STRUCTURES ≥ 50 sf

**Figure 1170-2  
 Sign Post Design Specifications**



Isotach in miles per hour for normal exposure for a fetch of 25+/- miles, based on 10 year interval.

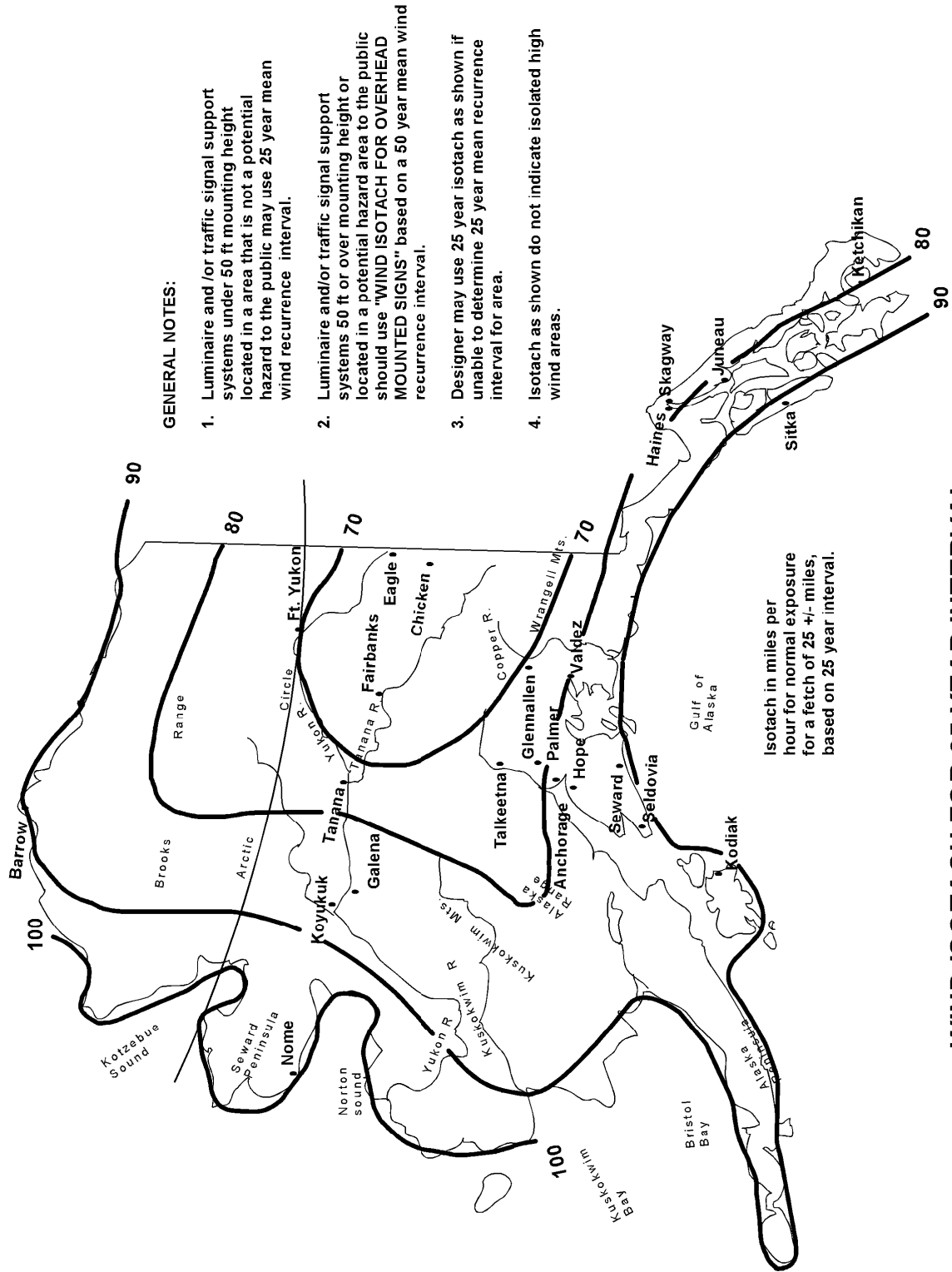
**WIND ISOTACH FOR 10 YEAR INTERVAL**

**GENERAL NOTES:**

1. Post mounted signs should be designed for 10 year mean recurrence interval.
2. Designer may use 10 year isotach as shown if unable to determine 10 year mean recurrence interval for area of sign installation.
3. Isotach shown does not indicate isolated high wind areas.

Figure 1170-3

Wind Isotach for 10-Year Interval



**GENERAL NOTES:**

1. Luminaire and /or traffic signal support systems under 50 ft mounting height located in a area that is not a potential hazard to the public may use 25 year mean wind recurrence interval.
2. Luminaire and/or traffic signal support systems 50 ft or over mounting height or located in a potential hazard area to the public should use "WIND ISOTACH FOR OVERHEAD MOUNTED SIGNS" based on a 50 year mean wind recurrence interval.
3. Designer may use 25 year isotach as shown if unable to determine 25 year mean recurrence interval for area.
4. Isotach as shown do not indicate isolated high wind areas.

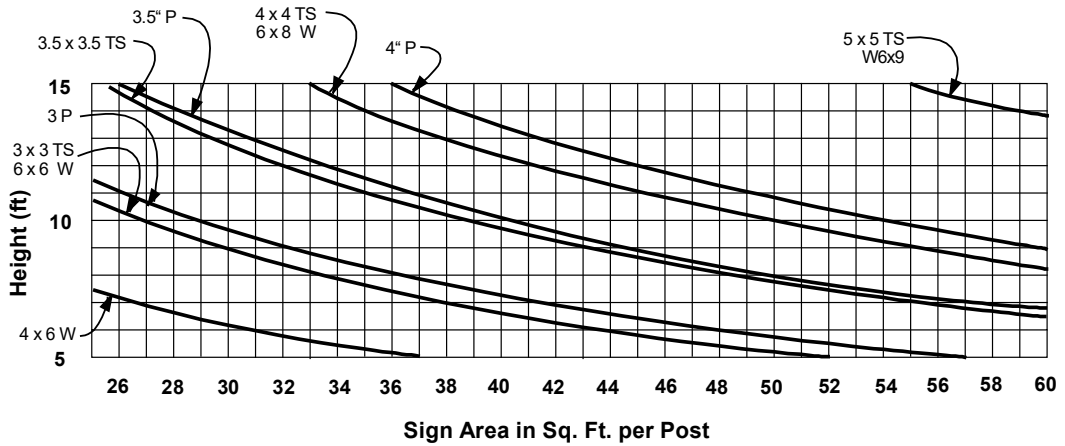
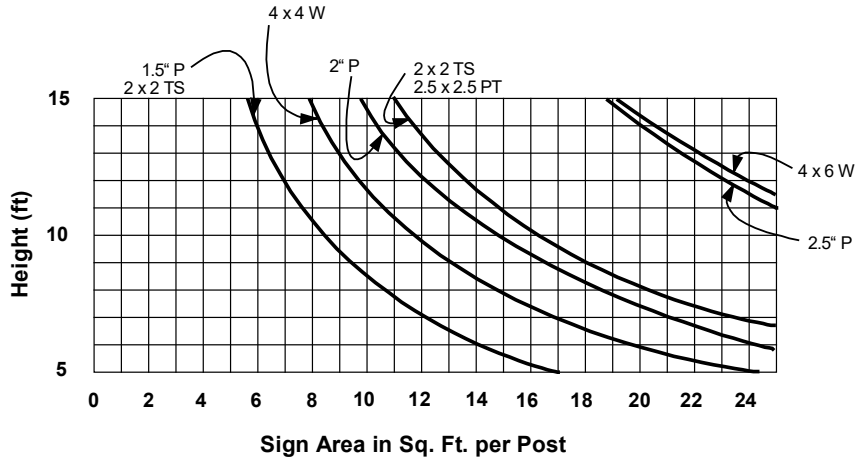
**Figure 1170-4**

**Wind Isotach for 25-Year Interval**

**WIND ISOTACH FOR 25 YEAR INTERVAL**





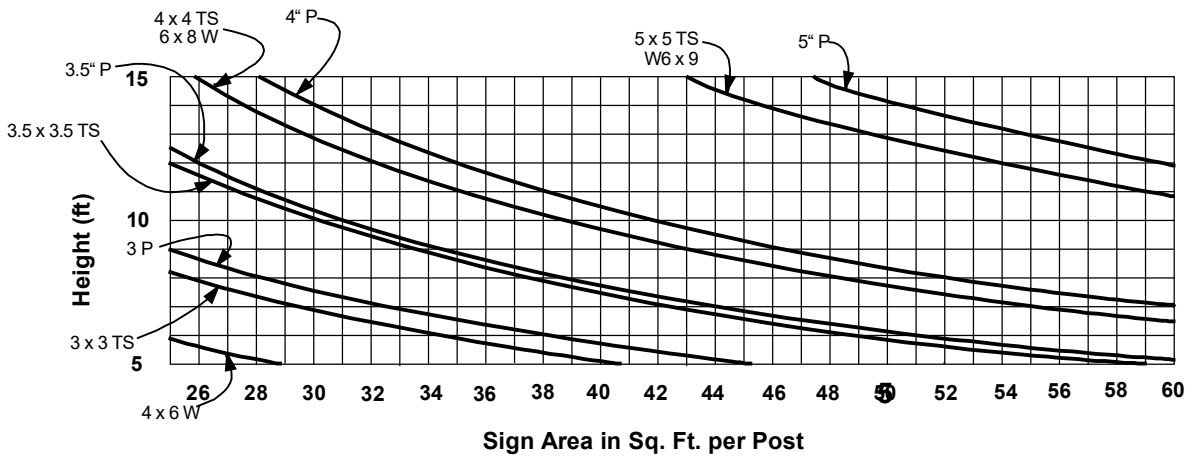
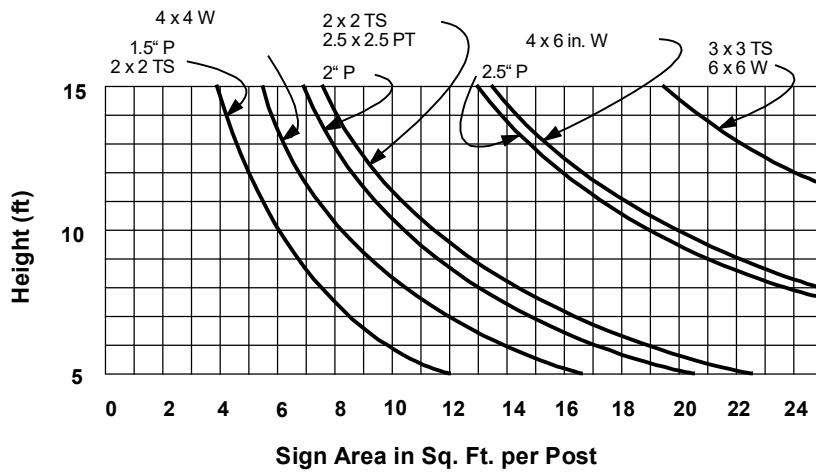


**POST MATERIAL**

- P.....Steel pipe (std. wt.)
- P.T.....Perforated steel tubing (0.105 in. wall)
- TS.....Steel tube square (0.1875 in. wall)
- \_x\_W.....Treated wood
- W\_x.....Steel W shapes

**SIGN POST SELECTION**  
**50 MPH DESIGN WIND VELOCITY**

**Figure 1170-6**  
**Sign Post Selection 50 mph Design Wind Velocity**

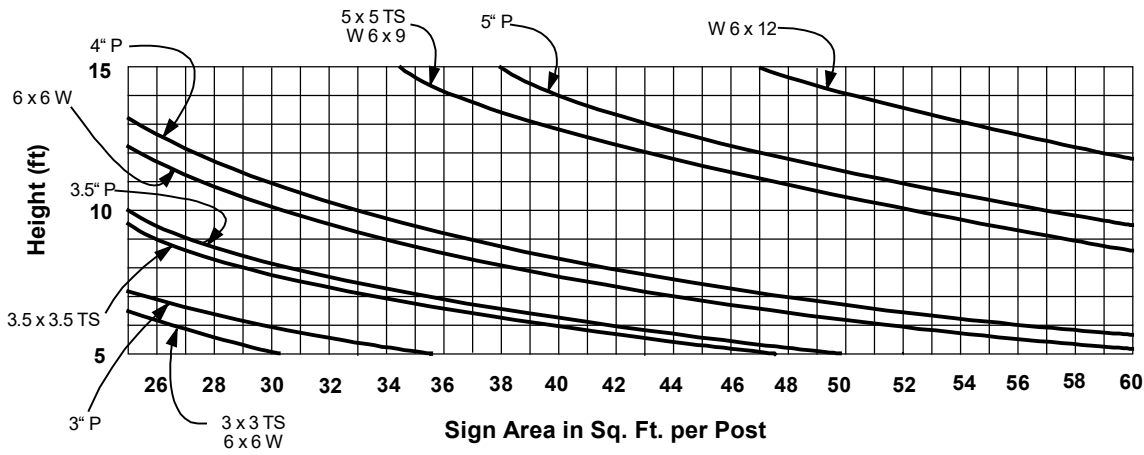
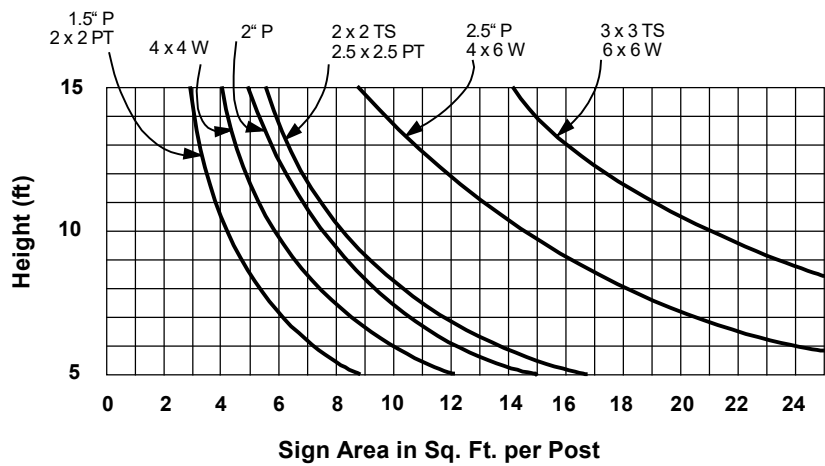


**POST MATERIAL**

- P.....Steel pipe (std. wt.)
- P.T.....Perforated steel tubing (0.105 in. wall)
- TS.....Steel tube square (0.1875 in. wall)
- \_x\_W....Treated wood
- W\_x.....Steel W shapes

**SIGN POST SELECTION**  
**60 MPH DESIGN WIND VELOCITY**

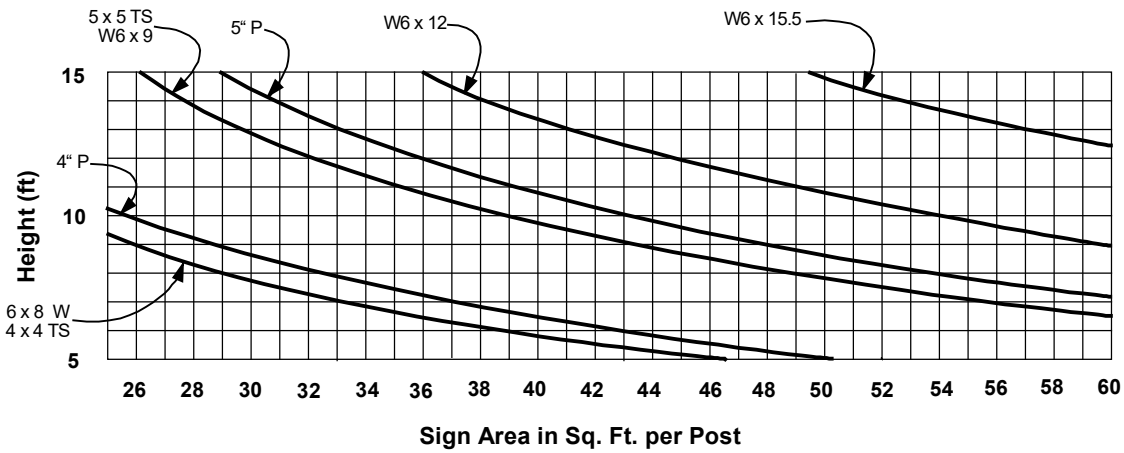
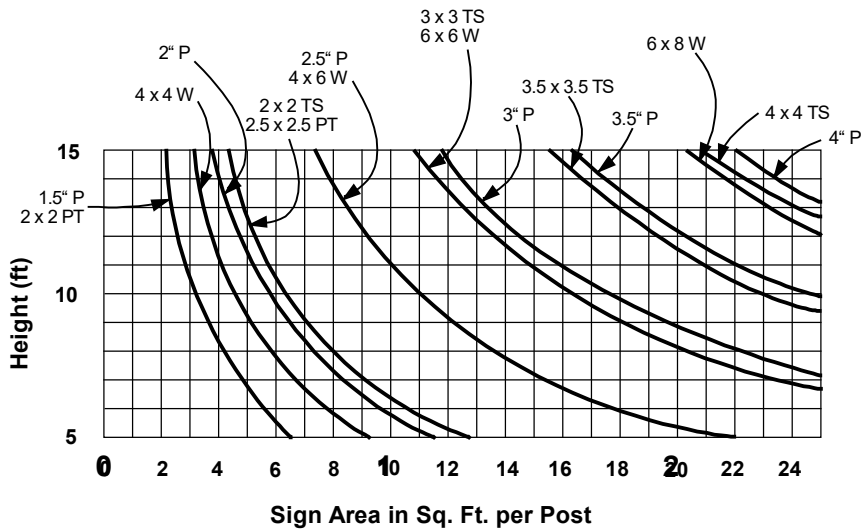
**Figure 1170-7**  
**Sign Post Selection 60 mph Design Wind Velocity**



**POST MATERIAL**  
P.....Steel pipe (std. wt.)  
P.T.....Perforated steel tubing (0.105 in. wall)  
TS.....Steel tube square (0.1875 in. wall)  
\_x\_W....Treated wood  
W\_x.....Steel W shapes

**SIGN POST SELECTION**  
**70 MPH DESIGN WIND VELOCITY**

**Figure 1170-8**  
**Sign Post Selection 70 mph Design Wind Velocity**

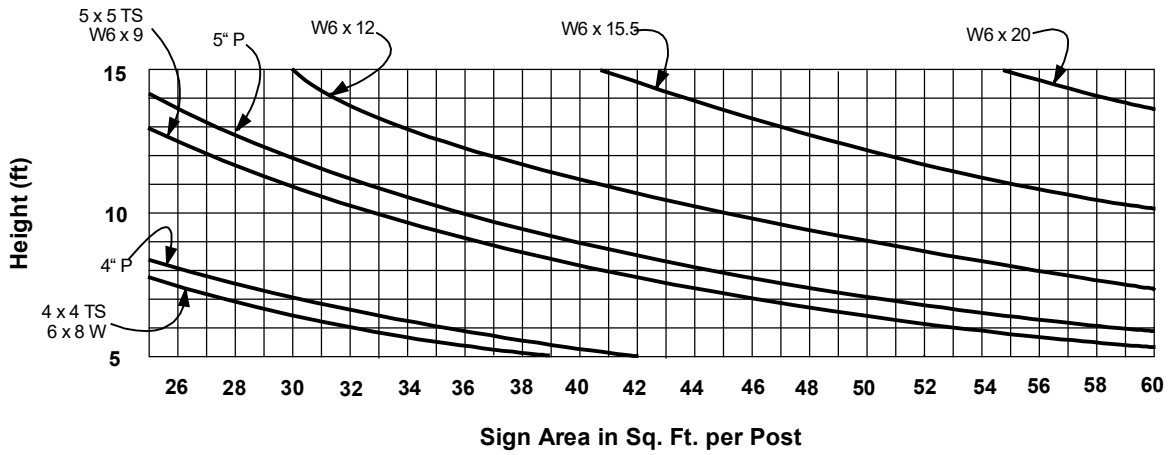
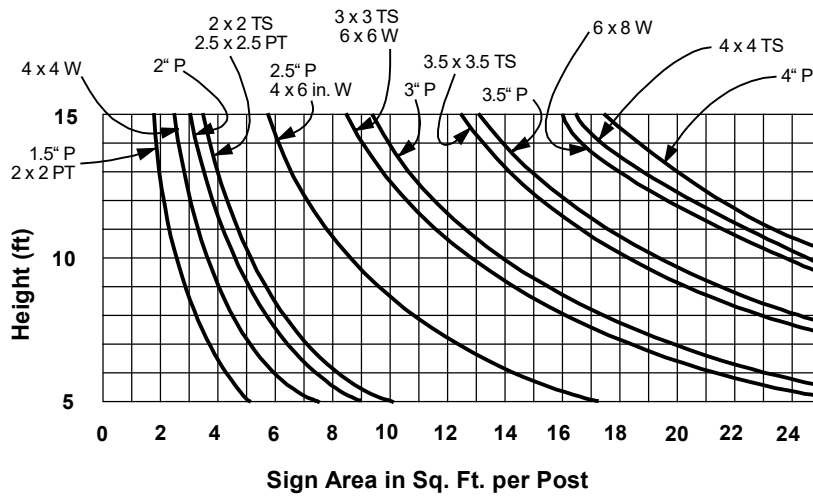


**POST MATERIAL**

- P.....Steel pipe (std. wt.)
- P.T.....Perforated steel tubing (0.105 in. wall)
- TS.....Steel tube square (0.1875 in. wall)
- X\_W....Treated wood
- W\_x.....Steel W shapes

**SIGN POST SELECTION**  
**80 MPH DESIGN WIND VELOCITY**

**Figure 1170-9**  
**Sign Post Selection 80 mph Design Wind Velocity**

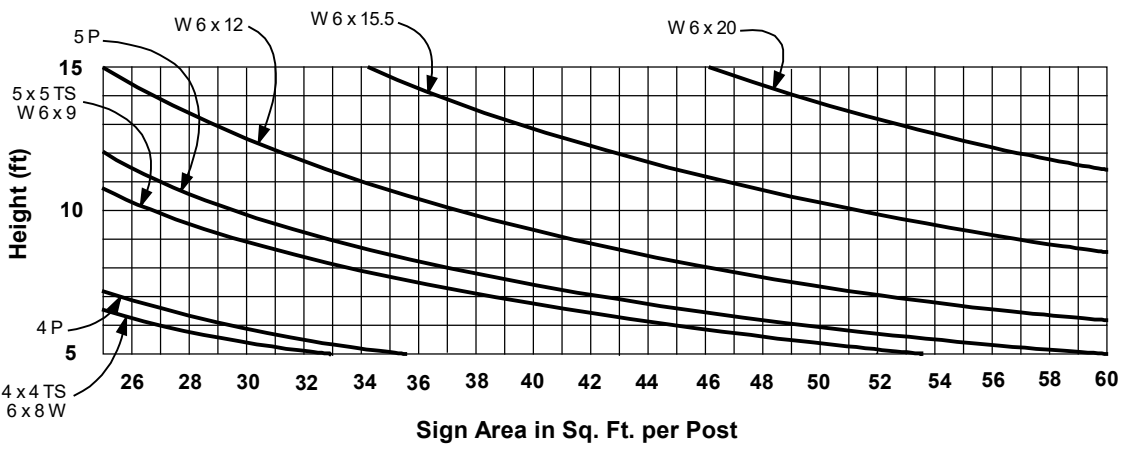
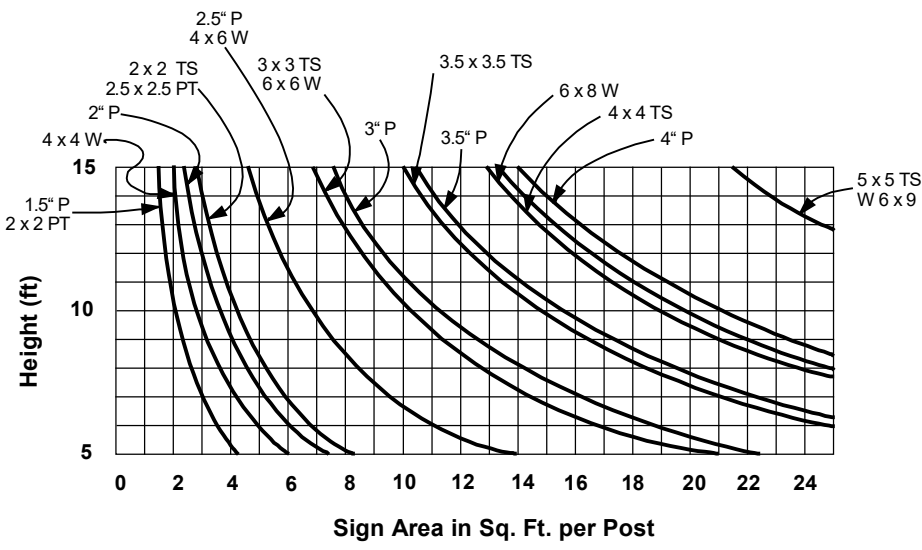


**POST MATERIAL**

- P.....Steel pipe (std. wt.)
- P.T.....Perforated steel tubing (0.105 in. wall)
- TS.....Steel tube square (0.1875 in. wall)
- \_x\_W....Treated wood
- W\_x.....Steel W shapes

**SIGN POST SELECTION**  
**90 MPH DESIGN WIND VELOCITY**

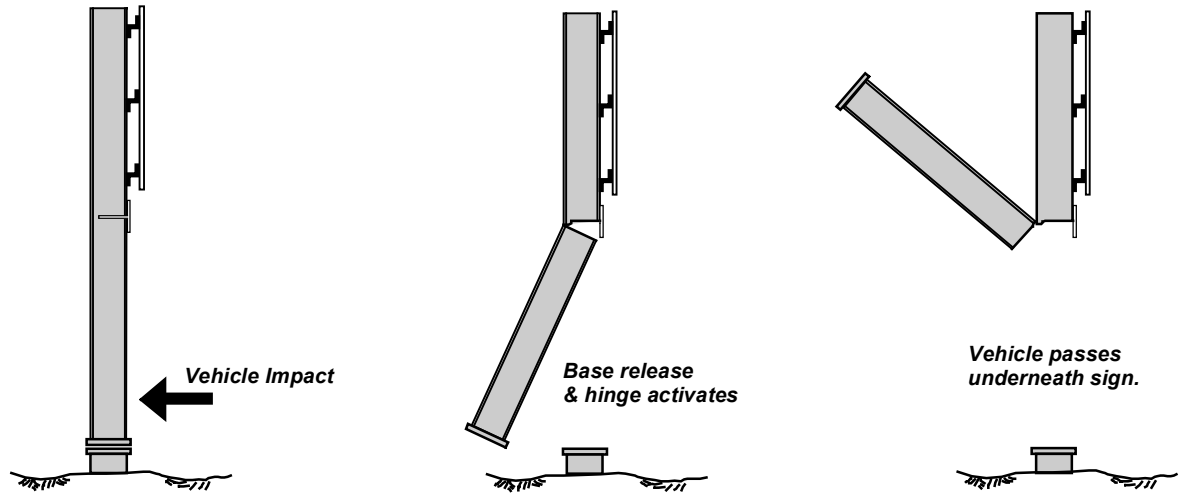
**Figure 1170-10**  
**Sign Post Selection 90 mph Design Wind Velocity**



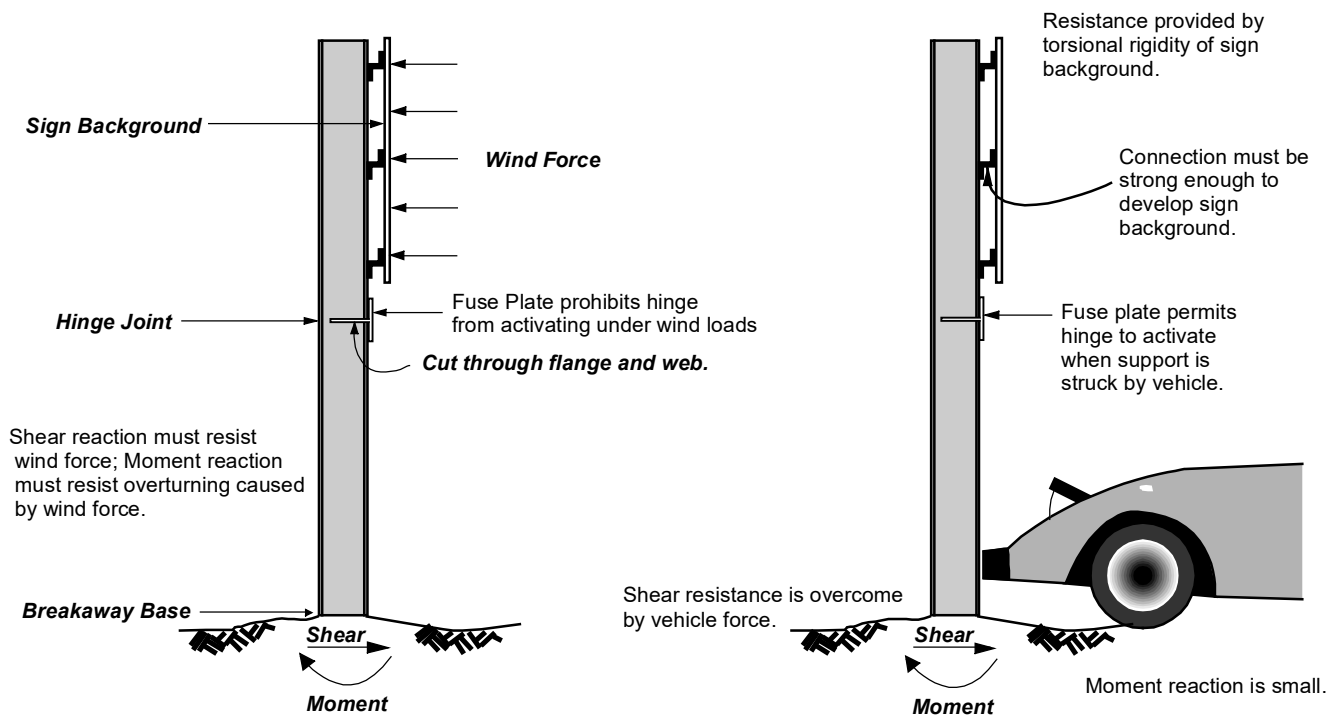
**POST MATERIAL**  
P.....Steel pipe (std. wt.)  
P.T.....Perforated steel tubing (0.105 in. wall)  
TS.....Steel tube square (0.1875 in. wall)  
x W.....Treated wood  
W\_x.....Steel W shapes

**SIGN POST SELECTION**  
**100 MPH DESIGN WIND VELOCITY**

**Figure 1170-11**  
**Sign Post Selection 100 mph Design Wind Velocity**



**VEHICLE IMPACT OPERATION**



**WIND LOADING CONDITION**

**COLLISION CONDITION**

**LARGE ROADSIDE SIGN SUPPORTS**

**Figure 1170-12  
Large Roadside Sign Supports**



This page intentionally left blank.

## 1180. Pavement Design

---

- 1180.1. Introduction
- 1180.2. Pavement Overview
- 1180.3. Wearing Course
- 1180.4. Binder Course
- 1180.5. Base Course
- 1180.6. Subbase/Select Material/Borrow
- 1180.7. Gravel Roads
- 1180.8. Glossary

### 1180.1. Introduction

Alaska's road transportation system is vital to the state's residents and economy. Pavements must withstand a variety of traffic and environmental conditions and must serve the public in a safe and comfortable manner. In addition, pavements are expected to perform over extended periods of time.

This chapter is an overview of the DOT&PF policy and design philosophy for pavements. Detailed policy and procedures that govern Alaska's flexible pavement design are provided in the *Alaska Flexible Pavement Design (AKFPD) Manual* and its companion software.

The *AKFPD Manual* is available online at:

[http://www.dot.state.ak.us/stwddes/desmaterials/mat/pvmtmgt/pop\\_flexpaveman.shtml](http://www.dot.state.ak.us/stwddes/desmaterials/mat/pvmtmgt/pop_flexpaveman.shtml).

### 1180.2. Pavement Overview

#### 1180.2.1 Pavement Structure

Pavement structure is a layered system of materials built on top of a prepared subgrade to protect it from excessive deformations due to traffic loads. In general, a pavement structure consists of (top to bottom): wearing course, binder course, base course (stabilized or unstabilized) and subbase or selected material (individually or in combination). The principal function of the layers is to distribute traffic load stresses within the pavement structure, thus protecting the subgrade from excessive deflection. Layer properties (i.e. density, strength, and stiffness) normally decrease from the top to the bottom of the system.

#### 1180.2.2 Highway Pavements

A pavement design analysis is required for all roadway projects requiring pavement construction, reconstruction, or rehabilitation. The regional

preconstruction engineer is responsible for the final pavement design.

#### 1180.2.3 Non-Highway Pavements

Pavement designs for non-roadway projects, such as parking areas, paths, and sidewalks, do not require the use of the *AKFPD Manual* procedure if the design equivalent single axel load (ESAL) is below 10,000. If the ESALs are 10,000 or more, then follow Section 2.2.4 of the *AKFPD Manual*. The minimum thickness of all non-highway hot mix asphalt pavements shall be 2 inches.

A Type II or III, Class C hot-mix asphalt may be used for parking areas, paths, and sidewalks with low ESALs. Section 401 of the *DOT&PF Standard Specifications for Highway Construction* (specifications) addresses Class C asphalt pavement.

### 1180.3. Wearing Course

The wearing course is the top layer of a surfacing system that is in direct contact with traffic loads. The wearing course is designed to:

- Provide resistance to abrasion
- Provide a smooth ride
- Resist plastic deformation
- Resist water permeability
- Resist fatigue
- Resist thermal cracking

Available surfacing types are listed in section 7.3 of the *AKFPD Manual*. Following are descriptions of some of the more common types of surfacing DOT&PF uses.

#### 1180.3.1 Hot Mix Asphalt (HMA)

Hot Mix Asphalt (HMA, or asphalt concrete pavement) is the predominant type of wearing course used on DOT&PF roadways. A pavement that receives such a surfacing is called a flexible pavement. HMA is appropriate for highway pavements, parking lots, pathways, and sidewalks.

HMA pavement structures are designed in accordance with the policies and design procedures in the *AKFPD Manual*. Use a minimum thickness of 2 inches for new and overlay HMA layers. The specifications cover HMA in Section 401.

### **1180.3.2 Asphalt Surface Treatment (AST)**

An AST is an asphalt/aggregate application to a road surface. Usually less than 1 inch thick, asphalt surface treatments do not increase the load bearing capacity of pavement structures. They provide friction and decrease dust generation. ASTs are appropriate when unstable embankments are present and/or for low-traffic roadways.

ASTs may be used if any of the following conditions are met (refer to Section 2.1 of the *AKFPD Manual*):

- The AADT is less than 1,000
- Life-cycle cost analysis supports their use
- Unstable foundations underlie more than 60 percent of the project
- The regional preconstruction engineer has approved them

Design ASTs using the *Asphalt Surface Treatment Guide*, which is available online at:

[http://www.dot.state.ak.us/stwddes/research/assets/pdf/fhwa\\_ak\\_rd\\_01\\_03.pdf](http://www.dot.state.ak.us/stwddes/research/assets/pdf/fhwa_ak_rd_01_03.pdf)

Section 405 of the specifications covers ASTs.

### **1180.3.3 Portland Cement Concrete (PCC)**

PCC is rarely used in Alaska pavements. High cost and damage due to foundation settlement preclude its use in roadways.

If a PCC pavement is used, consult the 1993 *AASHTO Guide for Design of Pavement Structures*. Consult the regional materials engineer for special provisions, specific concrete mix designs, and subgrade requirements.

### **1180.3.4 Gravel Surfacing**

See Section 1180.7 for guidance on gravel surfacing.

## **1180.4. Binder Course**

The binder course is the bottom layer of pavement below the wearing course. The binder course supports the wearing course. A binder course has all the properties of a wearing course except that resistance to abrasion is not essential. The minimum thickness of a binder course is 3 inches when placed on top of a non-stabilized base and 2 inches when placed on top of a stabilized base.

The wearing course and binder course may be composed of the same material when advantageous; however, the binder course often has a different asphalt content and gradation or hardness of aggregate. A binder course is not necessarily required in a specific pavement design.

### **1180.4.1 Hot Mixed Asphalt (HMA)**

Binder courses are usually HMAs, but in the case of overlays, the original wearing course layer becomes a binder course layer when topped with a new HMA layer.

The specifications cover HMA materials in Section 401.

### **1180.4.2 Recycled Asphalt Pavement**

Recycled asphalt pavement is the process of recycling old asphalt into new pavement by in-place cold mixing process or hot mixing at a plant. To be considered adequate as a binder course, a recycled asphalt pavement must have a resilient modulus greater than 300 ksi.

Consult the regional materials engineer for recycled asphalt pavement special provisions.

## **1180.5. Base Course**

The base course is the layer of material placed on top of the subbase or subgrade that supports the wearing and binder courses. A base course can be stabilized or non-stabilized.

Use of a bound stabilized base is required on all roadway construction, reconstruction, and rehabilitation projects except for:

1. Projects designed under the *Gravel to Pavement* program
2. Projects exempted in writing by the regional preconstruction engineer. Rationale for an exemption may include:
  - Projects with a low AADT
  - Areas underlain by unstable foundations, such as ice-rich permafrost, where settlement results in frequent maintenance
  - Projects for which a stabilized base will not provide a cost-effective improvement in the pavement performance, reduced maintenance, or reduced future rehabilitation costs through a comprehensive life-cycle cost analysis. The

period of the life-cycle cost analysis shall be 30 years.

- Roads designed on behalf of agencies other than DOT&PF

### **1180.5.1 Stabilized Bases**

Stabilized bases are normally defined as standard base course materials containing one or more of the following binder additives:

- Asphalt emulsion
- Asphalt cement
- Foamed asphalt cement
- Lime
- Portland cement
- Reclaimed asphalt pavement (RAP)

Stabilized bases are used to improve long-term pavement performance, reduce maintenance costs, and reduce future rehabilitation costs. While a stabilized base has no minimum amount of required binder additive, it must achieve a resilient modulus of at least 80 ksi.

The minimum thickness of a stabilized base is 3 inches. In developing flexible pavement designs using stabilized bases, refer to general policies GP5, 6, and 7 in Section 2.1 of the *AKFPD Manual*. In addition, use the following:

1. *Alaska Soil Stabilization Guide* (Report No. FHWA-AK-RD-01-6B)
2. The mechanistic design method used in the AKFPD computer program
3. The definition of stabilized layers as found in Section 7.4.1 of the *AKFPD Manual*

The *Alaska Soil Stabilization Guide* is online at:

[http://www.dot.state.ak.us/stwddes/research/assets/pdf/fhwa\\_ak\\_rd\\_01\\_06b.pdf](http://www.dot.state.ak.us/stwddes/research/assets/pdf/fhwa_ak_rd_01_06b.pdf)

The resilient modulus,  $M_R$ , of the stabilized base is determined from experience, back calculation, or testing and is a necessary input variable to run the AKFPD analysis program.

Following are stabilized bases used relatively frequently in Alaska:

#### **Asphalt Treated Base (ATB)**

Asphalt treated base (ATB) is a stabilized base course constructed using a minimum of 4 percent asphalt cement binder. ATB's primary use is as a binder

course in the Alaska Renewable Pavement (ARP) layering system. Refer to sections 7.4.2 and 7.4.3 of the *AKFPD Manual* for a detailed discussion of ATBs and the ARP. To be used as a binder course in the AKFPD method, an ATB must have a resilient modulus greater than 300 ksi.

There is some functional overlap with HMAs, but ATBs have different asphalt oil content, can use softer aggregate, and are less restrictive on aggregate gradation and in placing and leveling requirements. Therefore, they are more economical than HMAs.

Asphalt treated base course is addressed in section 306 of the specifications.

#### **Emulsified Asphalt Treated Base (EATB)**

Emulsified asphalt treated base course (EATB) is addressed in section 307 of the specifications.

When used with emulsified asphalt, crushed asphalt base course is also considered a stabilized base. Crushed asphalt base course is covered in Section 308 of the specifications.

#### **Reclaimed Asphalt Pavement (RAP)**

Reclaimed asphalt pavement (RAP) that contains greater than 50 percent asphalt concrete pavement or greater than 3 percent residual asphalt content is considered a stabilized base.

### **1180.5.2 Non-Stabilized Bases**

Non-stabilized bases comprise materials that do not have any binder additive. Crushed aggregate is the most common type of base course. Non-stabilized base course layers shall be a minimum of 4 inches thick.

Aggregate base course is covered in Section 301 of the specifications. Reclaimed asphalt pavement (RAP) may be used as base course, or blended with aggregate base course, when produced in accordance with section 308 of the specifications.

### **1180.6. Subbase/Select Material/Borrow**

The lower pavement structure typically includes subbase or selected material, individually or in combination. Where existing natural material is of adequate quality, it may serve as the lower portion of the pavement structure.

Section 304 of the specifications covers subbase.

## 1180.7. Gravel Roads

### 1180.7.1 General

Alaska has several existing major gravel roads and gravel surfacing is appropriate for some new, very low-volume roads in rural areas, where dust is not an environmental issue. This section has therefore been included in this “pavement design” section of the *Preconstruction Manual*.

Maintenance cost of gravel roads is considerably higher than that for HMA, AST, or PCC surfaced roads and is an important consideration when performing cost-effective or life-cycle cost analysis.

### 1180.7.2 Gravel Surface Structure

#### New Gravel Roads

The following references provide guidance that will assist in design of gravel roads:

- *AKFPD Manual*
- *AASHTO Guidelines for Design of Very Low-Volume Local Roads*
- *AASHTO Design of Pavement Structures-Part II* (Chapter 4 Low-Volume Road Pavement Design)
- Asphalt Institute *MS-1 Thickness Design Asphalt Pavements for Highways and Streets*.

When future paving of a gravel road is planned, evaluate the pavement structure in accordance with the design guidance appropriate to the anticipated future pavement type (i.e. *AKFPD Manual* for HAP).

Consult the regional materials engineer for more specific gravel roadway design guidance. Aggregate surface courses are addressed in section 301 of the specifications.

Consult the regional Maintenance and Operations (M&O) Section to determine if adequate personnel and equipment will be available to maintain the roadway prior to selecting gravel as surfacing.

#### Existing Gravel Roads

The roadway surfacing design process for existing gravel roads is as follows:

1. Evaluate the existing gravel road for previous performance and drainage system adequacy. M&O should participate.

2. Determine the adequacy of the embankment strength. Consider in the determination that the existing roadway structure will or will not support a base and surface course the recommendations from Materials, and Maintenance and Operations. Supplement as needed by structural support readings (i.e. Falling Weight Deflectometer, California Bearing Ratio, Dynamic Cone Penetrometer) or fines content.

If the embankment has adequate strength, provide sufficient aggregate surface course to shape cross slope and superelevation as a minimum. Aggregate surface course is addressed in section 301 of the specifications.

If the embankment does not have adequate strength, follow the guidance provided in the “New Gravel Roads” portion of this subsection.

## 1180.8. Glossary

The following is a brief glossary. A comprehensive glossary of asphalt design and construction terminology is found in the *AKFPD Manual*.

**AADT:** Average Annual Daily Traffic. AADT is a measure of traffic volume.

**Asphalt Concrete:** Also referred to as asphalt concrete pavement (ACP), hot mix asphalt (HMA), flexible pavement, and hot bituminous pavement. It is the material most commonly used for surfacing roadways and airports in Alaska that are subject to high traffic. ACP is a high-quality, controlled, hot mixture of asphalt cement and graded aggregate, thoroughly compacted into a uniform dense mass.

**Emulsified Asphalt:** A combination of ground asphalt, emulsifying agents, and water. It cures by “breaking,” which is water removal by evaporation or steaming off. Asphalt emulsions fall into three categories: anionic, cationic, and nonionic. The first two types are ordinarily used in roadway construction and maintenance. The anionic (electronegatively charged) and cationic (electropositively charged) classes refer to the electrical charges surrounding the asphalt particles. With nonionic emulsions, the asphalt particles are neutral. Cationic emulsions are used with aggregates that are negatively charged. Anionic emulsions are used with positively charged aggregates. Opposite charges attract. The relative setting time of either slow setting (SS), medium setting (MS), or rapid setting (RS) emulsions further categorizes emulsified asphalts.

**Emulsified Asphalt Treated Base (EATB):** A product of mixing base course material with emulsified asphalt and sometimes a few percent Portland cement. It can be mixed on grade by heavy equipment or by specially made traveling plants. It can also be produced in a central mixing plant. Emulsified asphalt treated bases bind up  $P_{200}$  in base course material and reduce frost heave and high moisture content. They also can create an effective structural support layer so that the otherwise required thickness of pavement or subbase can be reduced.

**ESAL:** An acronym for Equivalent Single Axle Load. An ESAL is the vertical load of a standard 18,000-pound, dual-tire, single-axle truck. The effect of pavement performance of any combination of axle loads is equated to the number of ESALs.

**Mix Design:** The project-specific combination of materials to be used in construction of a given pavement.

**Resilient Modulus ( $M_R$ ):** An elastic property of pavements and stabilized bases. The resilient modulus is defined as the ratio of repeated axial stress over the recoverable elastic strain.

This page intentionally left blank.

## 1190. Driveway Standards

---

- 1190.1. General
- 1190.2. Definitions
- 1190.3. Functional Classification
- 1190.4. General Principles
- 1190.5. Control Dimensions

### 1190.1. General

Driveways that intersect public roadways are a type of at-grade intersection. The numbers of accidents at driveway intersections are disproportionately higher than at public road intersections and consequently, driveway intersection design merits special attention.

The regional director or his or her designee may grant exceptions on driveways to be constructed or reconstructed along existing highways built to design standards prior to the *AASHTO A Policy on the Geometric Design of Highways and Streets 2001*. Driveways to be constructed or reconstructed along highways built according to the *AASHTO A Policy on the Geometric Design of Highways and Streets 2001* must follow the procedures of Section 1100.3. in the consideration of waivers from the driveway standards.

Use municipal geometric standards approved for use on Department roadways within a municipality instead of the geometric standards contained in this section for all driveways within the municipality.

The regional director will grant approval of municipal driveway geometric standards for use on roadways administered or maintained by the Department after review by the following people:

- Regional preconstruction engineer
- Regional director of maintenance and operations
- Headquarters chief engineer of Statewide Design and Engineering Services

### 1190.2. Definitions

(See Figures 1190-1 through 1190-7b).

**Angle of Intersection:** The horizontal angle of 90 degrees or less between the driveway centerline and the edge of the traveled way of the public roadway

**Buffer Area:** The border area along the property frontage between the edge of traveled way and the

right-of-way line bounded at each end by the frontage boundary lines

**Collector-Distributor Road:** An arterial road (usually one-way, with limited access) auxiliary to and adjacent to the side of a freeway for collection or distribution of traffic entering or leaving the freeway

**Clear Zone:** The roadside border area, starting at the edge of the traveled way, available for safe use by errant vehicles. Establishment of clear zone implies that rigid objects and other hazards with clearances less than the minimum width should be removed, relocated to an inaccessible position or outside the minimum clear zone, remodeled to make safely traversable or breakaway, or shielded.

**Corner Clearance:** The distance along the edge of traveled way of a public road or street from the near edge of traveled way of another public road or street to the tangent projection of the nearest edge of any driveway, not including transition slopes, tapers, or return-radii

**Distance Between Driveways:** The distance measured parallel to the centerline of roadway between intersection of the inside edges of two adjacent driveways and the right-of-way line

**Driveway Foreslope:** In cross-section, that portion of the driveway embankment that slopes downward from the driveway

**Edge Clearance:** The distance measured along the edge of traveled way between the frontage boundary line and the tangent projection of the nearest edge of driveway, not including returns, flares, or transition

**Frontage:** The length along the road or street right-of-way line of a single property tract, measured parallel to the centerline of the road or street, between the edges of the property. Corner property at a road or street intersection has a separate frontage along each road or street.

**Frontage Boundary Line:** A line perpendicular or radial to the public road or street centerline at each end of the frontage, extending from the right-of-way line to the edge of traveled way

**Frontage Road:** A local road auxiliary to and adjacent to the side of an arterial highway for service



to abutting property and adjacent areas and for control of access

**Interchange Ramp:** A turning roadway at an interchange for travel between intersecting legs

**May:** A term indicating permission. There is no requirement for design or application.

**Return:** The curbed or uncurbed edge of the road, street, or driveway intersection that connects the edge of the public roadway with the adjacent edge of the driveway or another public roadway; usually as a single radius

**Right-of-Way (ROW):** A strip of land owned by a municipality or the state upon which a public road is constructed

**Setback:** The distance measured perpendicular or radial to the right-of-way line and the nearest building, pump island, display stand, or other manmade object over 6 inches in height within the property

**Shall:** Where requirements in the design standards are described with the “shall” or “must” stipulation, it is mandatory to meet these requirements.

**Should:** An advisory term. Where the word “should” is used, the specific design criteria are recommended, but they are not mandatory. However, you should document why you did not follow the recommended criteria.

**Width:** The distance across the driveway at its narrow point within the right-of-way measured at right angles to the centerline of the driveway

### 1190.3. Functional Classifications

Highways, roads, and streets are classified according to their intended function as arterials, collectors, or local roads or streets. Arterials are primarily, if not exclusively, for through traffic along the roadway. Local roads and streets are primarily, if not exclusively, to provide access to the public road system from the property adjacent to the roadway. Collectors serve as limited through traffic ways and provide access from the adjacent property. For safety and efficiency, arterials should have few, if any, private driveways.

Freeways and expressways are special, high-design-type arterials that are exclusively for through traffic.

Access is legally controlled along the arterial and no private driveways are permitted.

Driveways will not be allowed on other arterials if other access is available. The Department’s primary concern is the safe, efficient movement of through traffic. If driveways directly accessing the arterial are necessary, then their number, location, and design will be controlled to minimize the effect on through traffic.

On local roads and streets, the roadway’s primary purpose is to provide access to adjacent lands. Consequently, the Department only exercises driveway controls that are necessary to a safe roadway. Collector roadways require more driveway controls than local roads and streets, but less than arterials.

Where there are differences in the required degree of control for driveway design and placement due to variance in functional classes, we provide differing criteria. The process of formally classifying Alaska roadways is not complete. If a particular roadway is not classified, the regional director or his or her designee will determine the interim classification for administering the driveway design standards.

### 1190.4. General Principles

1. **Buffer Area:** Buffer areas should be graded and landscaped to ensure adequate sight distance along the roadway, proper drainage, adequate clear zones, and a good appearance.
2. **Sight Distance:** The profile grade of a driveway and the treatment of the buffer area should allow the driver on the driveway to see sufficiently along the roadway to enable entry to the roadway without creating a hazard, and without encroaching into the traveled way (See Figure 1190-1).
3. **Setbacks:** The location of improvements on private property adjacent to the right-of-way line should not require parking, stopping, and maneuvering of vehicles within the right-of-way for vehicles or patrons to be properly served.
4. **Location of Driveways:** The location of driveways must minimize interference with the free movement of normal roadway traffic. This will reduce the hazards caused by congestion. Do not place driveways adjacent to or within an intersection. They also should not be located on

a separate turning roadway, auxiliary speed change lane, or exclusive turning lane. Driveway placement must not provide direct access to the through roadways, ramps, or collector-distributor roadways of a freeway or expressway.

5. **Number and Arrangement of Driveways:** The number of driveways provided to a property should be the minimum required to adequately serve the needs of that property. Frontages of 50 feet or less must be limited to one driveway per frontage. Not more than two driveways should be provided to any single property tract or business establishment, but where the single ownership frontage exceeds 1,000 feet, additional driveways may be allowed provided they are required for servicing the property, and the distance between adjacent driveways is at least 330 feet.

Where two driveways are provided for one frontage less than 1,000 feet long, the clear distance between driveways should not be less than the minimum distances presented in 1190.5., Control Dimensions. Corner clearances at intersections should also be in accordance with the distance shown in 1190.5.

Develop driveways and adjacent property so that vehicles entering any arterial or collector roadway are not required to do so by backing into the right-of-way. Develop all frontages having two or more driveways and all commercial developments so that backing into a public roadway isn't necessary. Multi-family residential developments of more than four units per lot are considered commercial development as far as driveway standards are concerned.

6. **Curbs:** Where the posted speed limit on an existing roadway or the design speed on a proposed roadway is 50 mph or greater, driveway curbs, if used, must be the mountable type and you must place them no closer to the edge of through traveled way than the outside edge of shoulder or 8 feet, whichever is greater. On rural roadways with speed limits or design speeds less than 50 mph, curbs, if used, should be mountable and placed at the outside edge of shoulder, but no closer than 4 feet from the edge of traveled way. Surface all roadway areas between the edge of traveled way and curbs

placed parallel to the edge of traveled way with the same material as the traveled way.

7. **Drainage:** Construct all driveways and buffer areas so that there will be no right-of-way surface drainage onto the traveled way of the public roadway. Where driveways are on the high side of a superelevated roadway, or are otherwise on a descending grade into the edge of traveled way, special drainage structures, including drop inlets or slotted drains, may be required to prevent non-right-of-way drainage from flowing into or across the public roadway traveled way. It is the responsibility of the property owner or permittee to maintain these drainage structures.

In addition, design and construction of the driveway and buffer must not impair or alter drainage within the right-of-way, which may damage or threaten the stability of the public roadway. All drainage facilities within the right-of-way must conform to any applicable Department standards.

8. **Embankment (Transverse Slopes):** Driveway foreslopes, when constructed in a roadway ditch section on high-speed roadways, should have a 6:1 or flatter slope within the roadway's clear zone. Low-speed roadways or urban areas may have transverse foreslopes steeper than 6:1. Refer to Section 1130.3.1 and the 2002 *AASHTO Roadside Design Guide* Section 3.2.3, Transverse Slopes, for additional information on driveway transverse slopes within the clear zone.
9. **Lighting:** The Department will not provide roadway illumination solely for private driveways. The adjacent property owner may, except as stated here, install such lighting as long as it conforms to accepted highway lighting criteria in the AASHTO publication *An Informational Guide for Roadway Lighting*. A property owner may not illuminate a driveway if it is within 500 feet of an unlit public road intersection.
10. **Anticipated Traffic:** It is not necessary to estimate the volume of traffic for the majority of driveways. However, for larger developments it may be desirable, if not necessary, to do so to determine the number, size, and design of the driveways needed to serve the development. A

few well-designed driveways are preferable to many smaller driveways.

When the volume of traffic is expected to exceed 100 vehicles during the peak hour, a competent licensed professional engineer should conduct an analysis of the vehicle trip generation characteristics of the development. If such an analysis is not available, you may use the average trip generation factors in Table 1190-1, which are based on the Institute of Transportation Engineers Informational Report, *Trip Generation, 3rd Edition*, to determine anticipated traffic for establishing the number, size, and design of driveways needed to accommodate the development.

“Peak hour” is the peak traffic-generating hour of the off-street facility.

**Table 1190-1  
Average Trip Generation Factors \***

<u>Type of Development</u>	<u>Peak Hour Trips</u>
Apartments and other residential units	1.00 trips per dwelling unit
Hotels and motels	1.00 trips per room
Schools (All)	0.25 trips per student
Industrial facilities	0.50 trips per employee
Hospitals	1.36 trips per bed
Nursing homes	0.36 trips per bed
Clinics	2.48 trips per 1,000 sf*
General office buildings	2.00 trips per 1,000 sf
Medical office buildings	3.90 trips per 1,000 sf
Civic centers	2.85 trips per 1,000 sf
Post offices, motor vehicle offices and other high-turnover public services	11.00 trips per 1,000 sf
Discount stores	6.97 trips per 1,000 sf
Hardware stores	5.20 trips per 1,000 sf
Shopping centers, per feet squared	
0-50,000 sf	$Trips = 110 \sqrt{\frac{\text{Size of Shopping Center in sf}}{1,000}}$
50,000-1,500,000 sf	$Trips = 3.22 \left[ \frac{\text{Size of Shopping Center in sf}}{1,000} \right] + 614$
Service stations	6.00 trips per pump (two hoses)
Car wash	132.00 trips per site
Truck stop	88.00 trips per site
Supermarket	15.7 trips per 1,000 sf
Convenience market	47.0 trips per 1,000 sf
Wholesale markets	0.52 trips per 1,000 sf
Furniture stores	0.10 trips per 1,000 sf
Banks	30.00 trips per 1,000sf
Savings & Loan offices	9.70 trips per 1,000 sf
Insurance offices	2.40 trips per 1,000 sf

\* Average number of one-way trips generated (or attracted) by a given facility during the peak generating (or attracting) hour of the facility. This peak may or may not coincide with peak traffic flow on the adjacent street. Where the average time of the motorist at the generator (or attractor) is less than one hour, the flow is half into the facility and half out. (Example: Truck stops with 88 peak hour trips per site would represent 44 inbound and 44 outbound trips.) Trips based on area are based on gross leasable floor area.

11. **Median Openings:** Where a median exists or is to be constructed on a public roadway, driveways should be designed and controlled to allow right turns only. Median openings should not be provided for driveways unless all the following conditions exist:

- a. There is a sufficient volume of traffic using the subject driveway to warrant driveway intersection design as a public intersection.
- b. The driveway intersection is evenly spaced between adjacent arterial or collector intersections.
- c. Installation of a signal at present or in the future at the subject driveway intersection will not adversely affect the capacity of the public roadway.

To minimize wrong way movements on the divided public roadway, driveways planned near a median opening should be placed either directly opposite the median opening or at least 200 feet from the median opening.

12. **Design Vehicles:** Refer to AASHTO *A Policy on the Geometric Design of Highways and Streets 2001*, Chapter 2, Design Vehicles General Characteristics, for guidance in selecting the appropriate design vehicle for the driveway. At least one driveway shall have widths, intersection alignments, and corner radii designed to accommodate the turning paths of the largest vehicles generated by the site. This would include large single units or tractor-trailer combination vehicles that deliver freight.

### 1190.5. Control Dimensions

Specific control dimensions implement the general principles in 1220.4. Exceed minimum dimensions as much as possible. Due to differing conditions in rural and urban areas, different dimensions are provided. Where appropriate, the control dimensions also reflect the difference between differing functional classes of roadways.

In administering these driveway standards, urban areas have populations of 500 or more within a defined compact area. The defined area need not be incorporated, but an incorporated place containing

500 people would be an urban area. Unincorporated places that have the characteristics of an incorporated community of 500 should be considered urban. In addition, if a roadway has urban characteristics such as small lot frontages, you may use the urban control dimensions.

1. **Sight Distances:** Figure 1190-1 illustrates the unobstructed sight distance along the public roadway, which should be available to a motorist entering the roadway. On arterial collector roadways, if the appropriate sight distance cannot be reasonably achieved, relocate the driveway.

The sight line used to set sight distance is from the entering height of eye (3.5 feet above the driveway surface) to the driver eye height of the design vehicle (3.5 feet above the surface of the public roadway at the required distance from the driveway). The driver's eye is assumed to be between 14.4 to 17.8 feet from the edge of the nearest through traveled way, and the triangle formed by the sight lines left and right from this point to the required sight distances left and right along the public roadway is the sight distances triangle. Nothing should substantially obstruct the entering driver's view of public roadway traffic anywhere within this triangle.

2. **Width:** Residential driveways, rural and urban, should be a minimum of 14 feet wide and a maximum of 20 feet wide. Rural farm driveways should be a minimum of 14 feet wide and a maximum of 24 feet wide to accommodate machinery. Commercial driveways should be a minimum of 24 feet wide for traffic volume up to 100 vehicles per hour and may be a maximum of 34 feet wide for up to 200 vehicles per hour. Where repetitive peak hour traffic is expected to exceed 200 vehicles per hour, the driveway should be designed as a normal street intersection in accordance with the AASHTO publication *A Policy on the Geometric Design of Highways and Streets, 2001* as modified by Chapter 11 – Design of the Department's *Alaska Highway Preconstruction Manual*.

3. **Driveway Angle:** The driveway angle should be 90 degrees. It must not be less than 60 degrees except where designed as a one-way, one-lane,

right-turn-only ramp, in which case it should be designed in accordance with *A Policy on the Geometric Design of Highways and Streets 2001* (AASHTO).

4. **Return Radii:** Curb or edge of pavement returns should connect the edge of the driveway with the face of curb on curbed roadways and with the edge of a 9-foot paved shoulder on uncurbed roadways. Where uncurbed roadways have paved shoulders less than 9 feet wide, the return should terminate 8 feet from the edge of traveled way and be connected to the edge of pavement (traveled way or paved shoulder) with a 10:1 taper (10 feet longitudinally along the roadway for each 1 foot transversely).

The return radii for driveways using returns, curbed or uncurbed, should conform to Table 1190-2.

5. **Curb Cuts:** The bottom width of curb cuts should equal the width of driveway and should match the flow line (or bottom of curb face line) of the curb section at the edge of roadway. Transitional slopes should begin at the edge of driveway and slope upward to reach the top of a 6-inch-high curb face in 6 feet. The transitional slopes behind the curb face may have a constant width with a variable slope or a constant slope with a variable width.
6. **Distance between Driveways:** The minimum distance between two adjacent driveways, on the same parcel, measured along the right-of-way line between the adjacent edges, should conform to Table 1190-3.
7. **Setback:** Setback distances must conform to local zoning requirements. Where local zoning ordinances do not provide a minimum setback, the minimum setback should be 16.5 feet, and where angle parking is permitted adjacent to the right-of-way line, the setback should be 50 feet.
8. **Edge Clearance:** The property line edge clearance should be equal to the return radius for driveways using returns and should be 16.5 feet for driveways using curb cuts with transitional slopes. *Exception:* Where a common-use driveway is to serve two adjoining properties, the approximate centerline of the driveway may be on the frontage boundary line.

9. **Corner Clearance:** The minimum distance from the nearest face of the curb, or nearest edge of traveled way for uncurbed roadways, of an intersecting public roadway to the nearest edge of driveway should conform to Table 1190-4.

10. **Driveway Profiles:** The maximum access grade for a residential driveway should be 15 percent. Commercial driveways should have a maximum algebraic difference of 8 percent between access grade and landing grade. The maximum landing grade is  $\pm 2$  percent for all driveways. Driveway profiles must conform to the following descriptions.

- a. **Driveway with Uncurbed Returns:** Public roadway with a negative cross-slope (i.e. outer edge of traveled way lower than lane or centerline):
  - From the outer edge of the traveled way to the edge of the shoulder or 9 feet, whichever is greater, the driveway profile grade should be the same as the traveled way or shoulder cross-slope.
  - From the outer edge of the shoulder, a vertical curve should connect the profile to a positive or negative grade, which will bring the driveway profile to the adjacent property grade.
- b. **Driveway with Curbed Returns:** Public roadway with a negative cross-slope (i.e. outer edge of traveled way lower than lane or centerline):
  - Beginning with an angle point at the flow line (bottom of face of curb) along the roadway, the driveway profile should rise at a gradient such that the algebraic difference in grade between the cross-slope of the roadway and the grade of the driveway does not exceed 8 percent.
  - A landing zone must begin after a rise of 6 inches.
- c. **Driveway with Returns:** Public roadway with positive cross-slope (i.e., on high side of superelevated section):

- From the outer edge of traveled way to the edge of the shoulder or 8 feet, whichever is greater, the driveway profile grade should be the same as the traveled way superelevation rate.
- From the outer edge of the shoulder, a vertical curve should connect the profile to a positive or negative grade, which will bring the driveway profile to the adjacent property grade

d. **Driveway with Curb Cuts**

- From the bottom face of curb or flow line, the driveway profile grade should slope uniformly upward at a grade not to exceed an algebraic difference of 8 percent with the adjacent lane or shoulder cross-slope.
- If a sidewalk or portion thereof remains to be crossed, the driveway profile may match the surface of the sidewalk.
- The profile should then follow a vertical curve or have an angle point, if necessary, to connect with a positive or negative grade, which will bring the driveway profile to the adjacent property grade.

e. **Vertical Curves:** Vertical curve should be symmetrical and as flat as feasible. Crest vertical curves should not exceed a 3...-inch hump in a 12-foot chord, and sag vertical curves should not exceed a 2-inch depression in a 12-foot chord. Vertical curves must not have humps or depressions exceeding 3.6 inches in a 12-foot chord.

f. **Landings:** All driveways are to have landing zones. Landing length depends on anticipated traffic. Passenger cars require 12 feet minimum while semi-tractor trailers require 30 feet based on wheel bases.

g. **Pedestrian Areas:** Where curbed returns intersect a pedestrian way, provide appropriate handicapped access ramps.

required for the acceleration or deceleration of vehicles entering or leaving the public roadway from or to a higher-volume traffic generation (greater than or equal to 100 vehicles per hour) or attracting development. Use Figure 4-3 of NCHRP 279 Intersection Channelization Design Guide as a guideline for the right-turn treatments. On a one-way street, the above criteria also apply to the left through lane. For guidelines on the need for left-turn lanes on a main street or road at a driveway, refer to Exhibit 9-75 in AASHTO *A Policy on the Geometric Design of Highways and Streets 2001*.

11. **Speed Change Lane and Left-Turn Lanes:** On high-speed (50 mph or over) or high-volume arterial roadways, speed change lanes may be

**Table 1190-2  
Driveway Return Radii (feet)**

<u>Driveway</u> Width (ft)	<u>Residential</u>		<u>Farm</u>		<u>Commercial</u>	
	Curbed	Uncurbed	Curbed	Uncurbed	Curbed	Uncurbed
14 - 20	*20	20	-	20	-	-
24 - 34	-	-	-	40	*40	40

\* For curbed roadways where residential driveways or commercial driveway have a 100-vehicles-per-hour or fewer repetitive peak, use a curb cut rather than a return.

**Table 1190-3  
Distance Between Driveways**

*(On Same Parcel)*

<b>Hourly Volume &gt; 10 vph</b>			
<b>Speed (mph)</b>	<b>Rural Arterial and Collector Roads</b>	<b>Urban Arterial and Collector Streets</b>	<b>Urban and Rural Local Streets and Roads</b>
30	370 feet	200 feet	200 feet
35	400 feet	260 feet	250 feet
40	440 feet	340 feet	310 feet
45	540 feet	430 feet	390 feet
50	690 feet	510 feet	490 feet
<b>Hourly Volume Less than or equal to 10 vph</b>			
<b>Functional Classification</b>		<b>Distance</b>	
Arterial roadways		75 feet	
Collector roadways		50 feet	
Local roadways		35 feet	

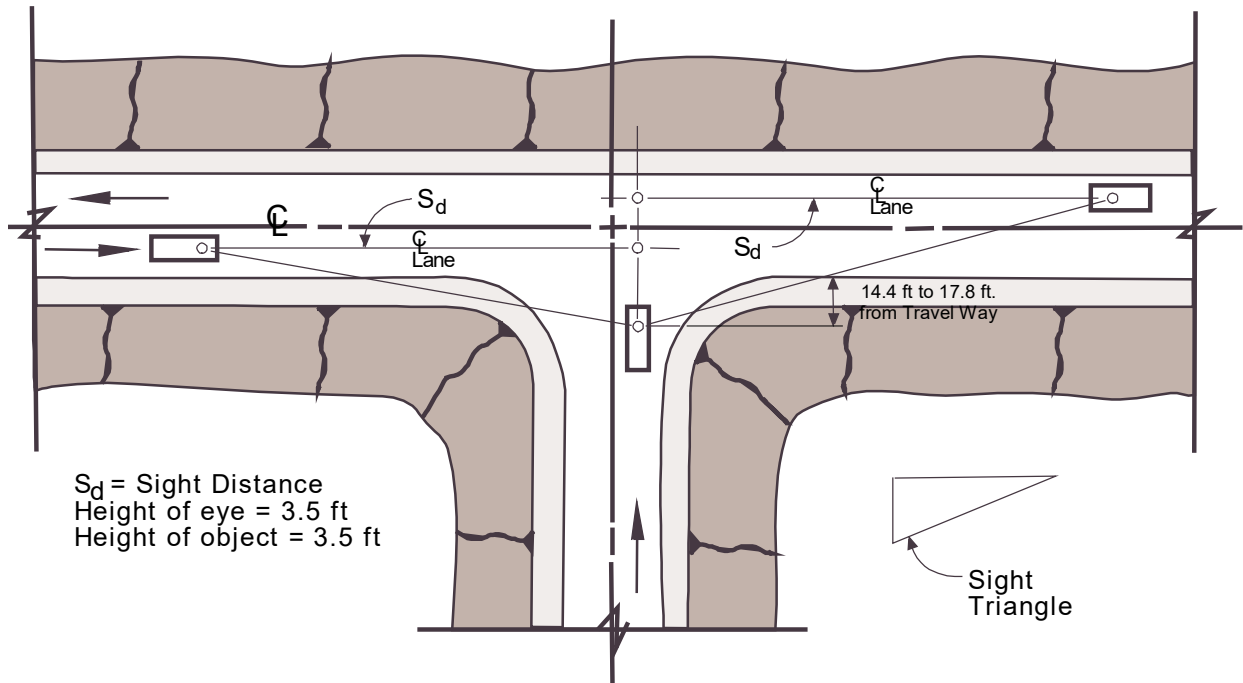


**Table 1190-4  
Corner Clearance**

<b>Hourly Volume less than or equal to 10 vph</b>			
<b>Corner Clearance (Feet)</b>			
<b>Functional Classification</b>	<b>Curbed Crossroad</b>	<b>Uncurbed Crossroad</b>	
		<b>Urban</b>	<b>Rural</b>
Arterial roadways	60 feet	70 feet	100 feet
Collector roadways	50 feet	60 feet	60 feet
Local roadways	40 feet	50 feet	60 feet

<b>Hourly Volume &gt; 10 vph</b>			
<b>Speed (MPH)</b>	<b>Major Generator &gt;250 vph</b>	<b>Medium Generator 100 - 250 vph</b>	<b>Small Generator &lt;100 vph</b>
30	200 feet	150 feet	80 feet
35	260 feet	210 feet	110 feet
40	330 feet	260 feet	150 feet
45	390 feet	310 feet	180 feet
50	460 feet	340 feet	230 feet

## DRIVEWAY SIGHT DISTANCE



DESIGN SPEED or POSTED SPEED LIMIT mph	SD MINIMUM (ft)
20	115
25	155
30	200
35	250
40	305
45	360
50	425
55	495
60	570
65	645

Note: Minimum sight distances are stopping sight distances for level grades, between -3% and +3%. Refer to AASHTO *A Policy on the Geometric Design of Highways and Streets 2001*, for desirable intersection sight distances and for grade adjustments.

**Figure 1190-1  
Driveway Sight Distance**

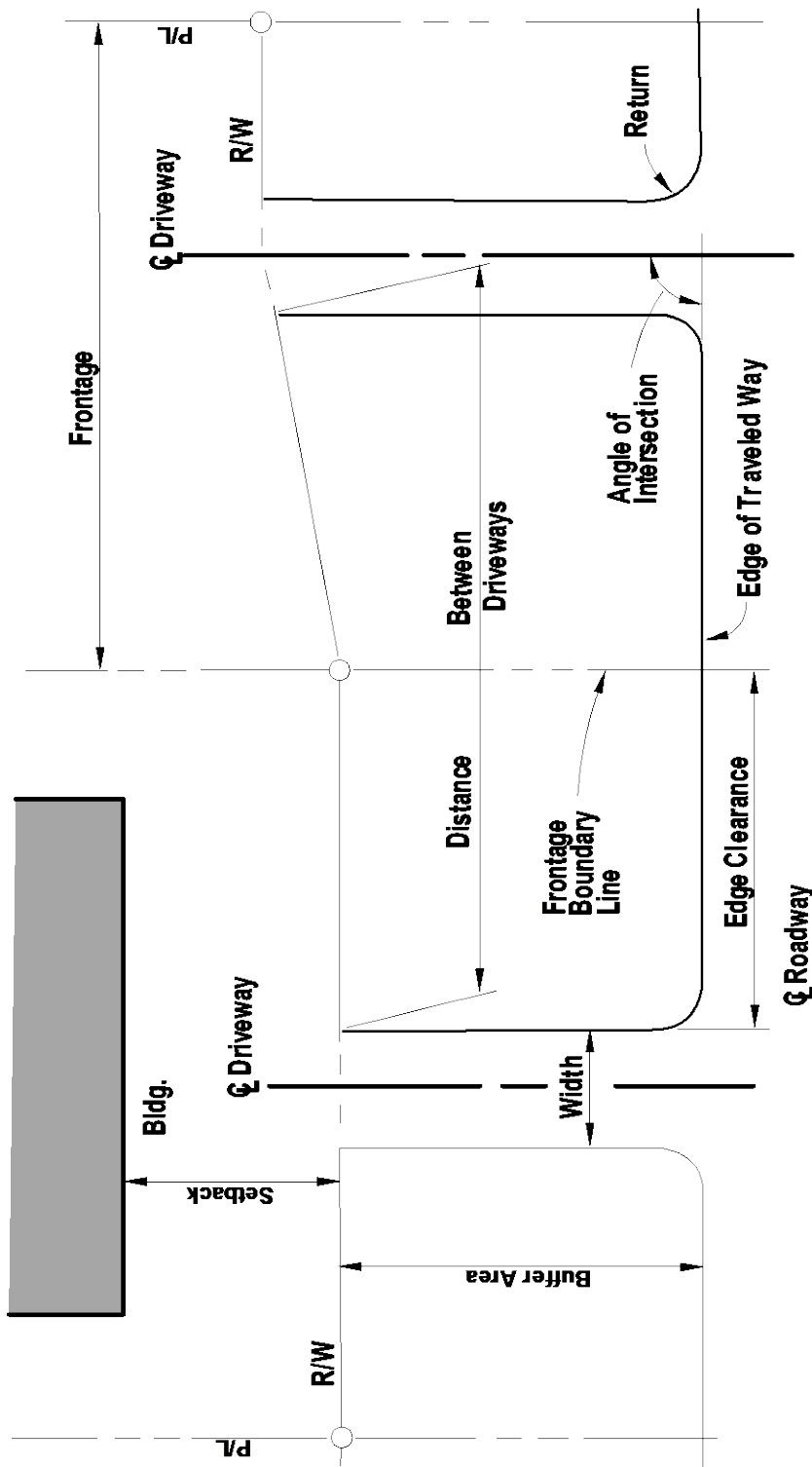
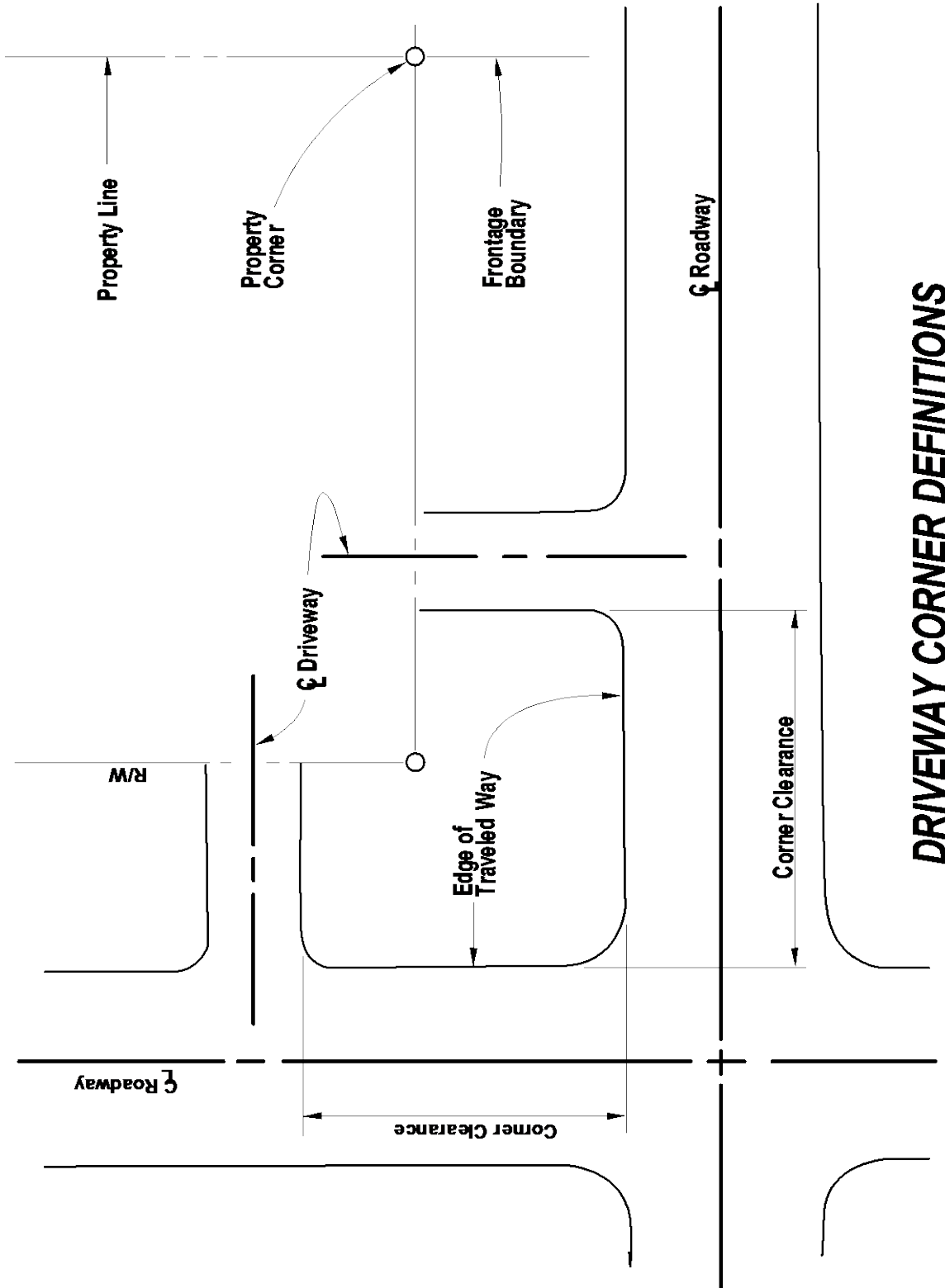


Figure 1190-2  
Driveway Definitions

## DRIVEWAY DEFINITIONS



**DRIVEWAY CORNER DEFINITIONS**

Figure 1190-3  
Driveway Corner Definitions

Landing Dimensions	
Usage	Minimum
Passenger Cars	10 ft
Semi Tractor Trailers	30 ft

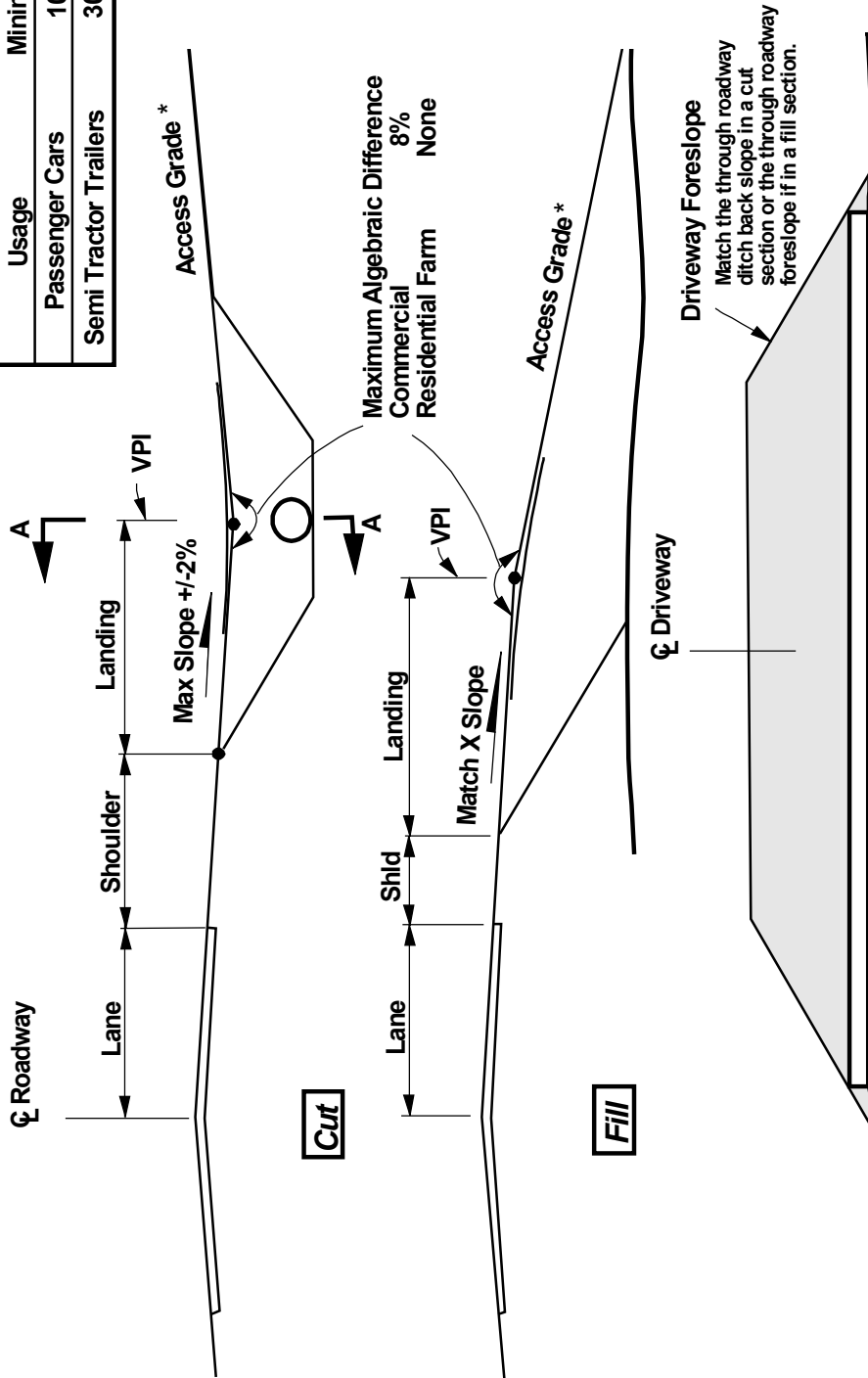


Figure 1190-4  
Driveway Profiles

\* Access Grade  
Max. 15%  
Residential/Farm

## DRIVEWAY PROFILES

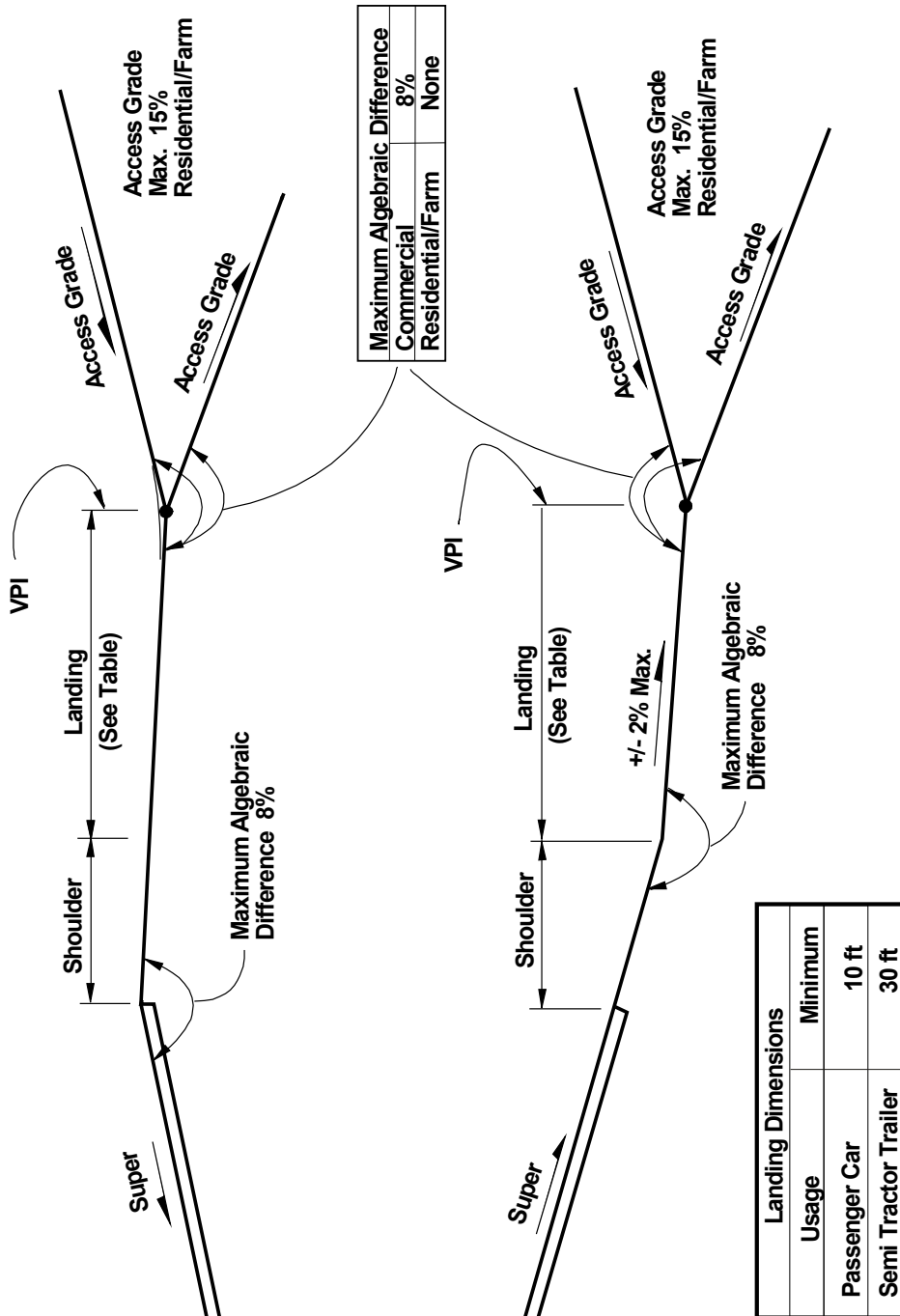
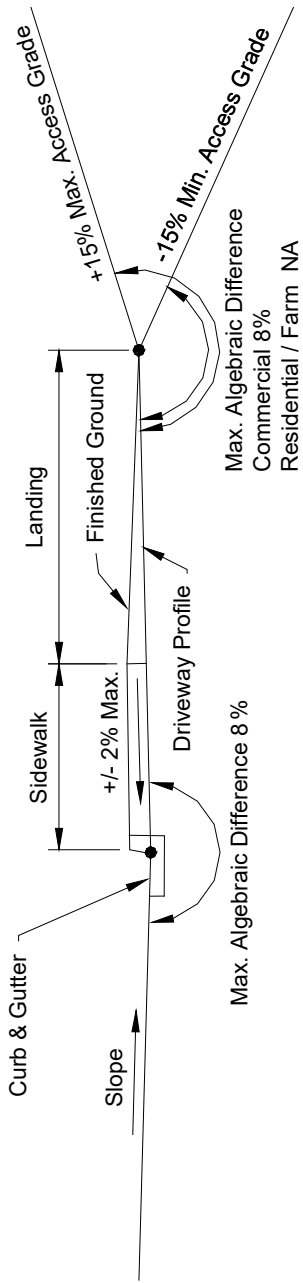


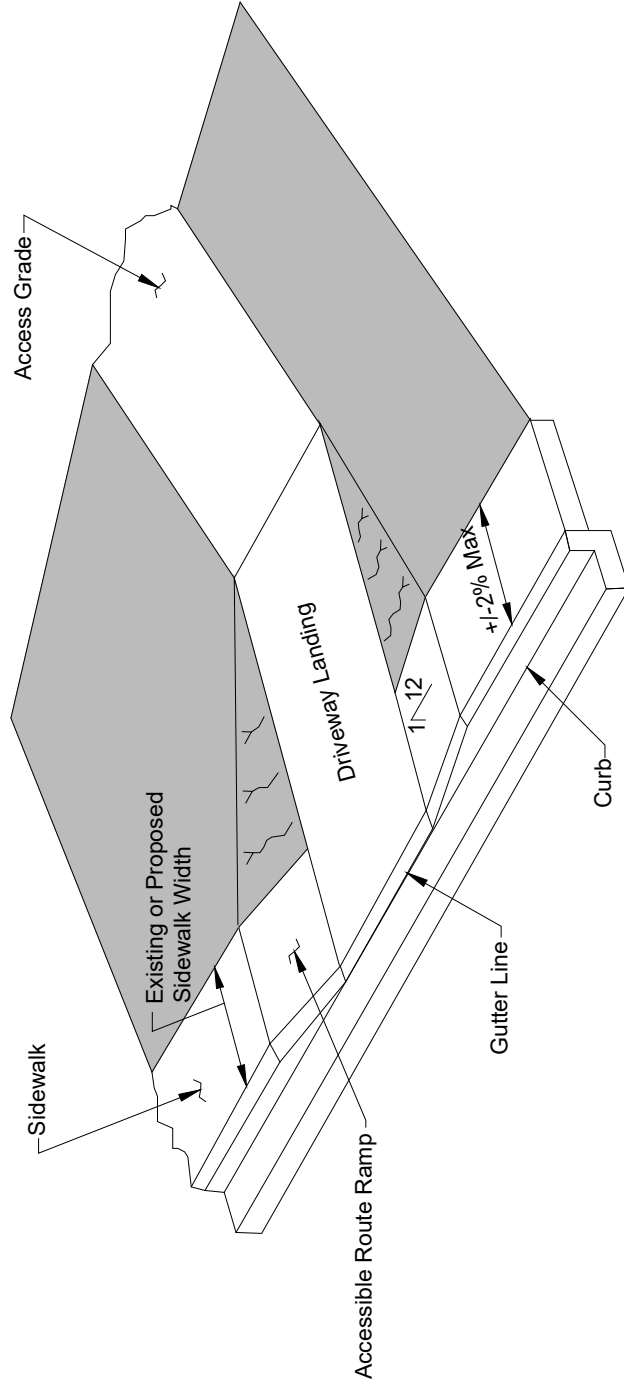
Figure 1190-5  
Driveway Profiles With Super

**DRIVEWAY PROFILES with SUPER**



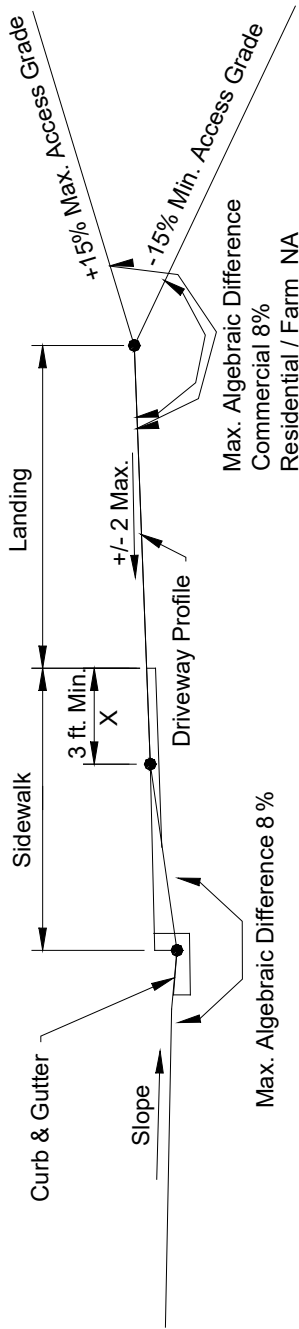
CURB CUT PROFILE

Landing Dimensions	
Usage	Minimum
Passenger Car	10 ft
Semi Tractor Trailer	30 ft



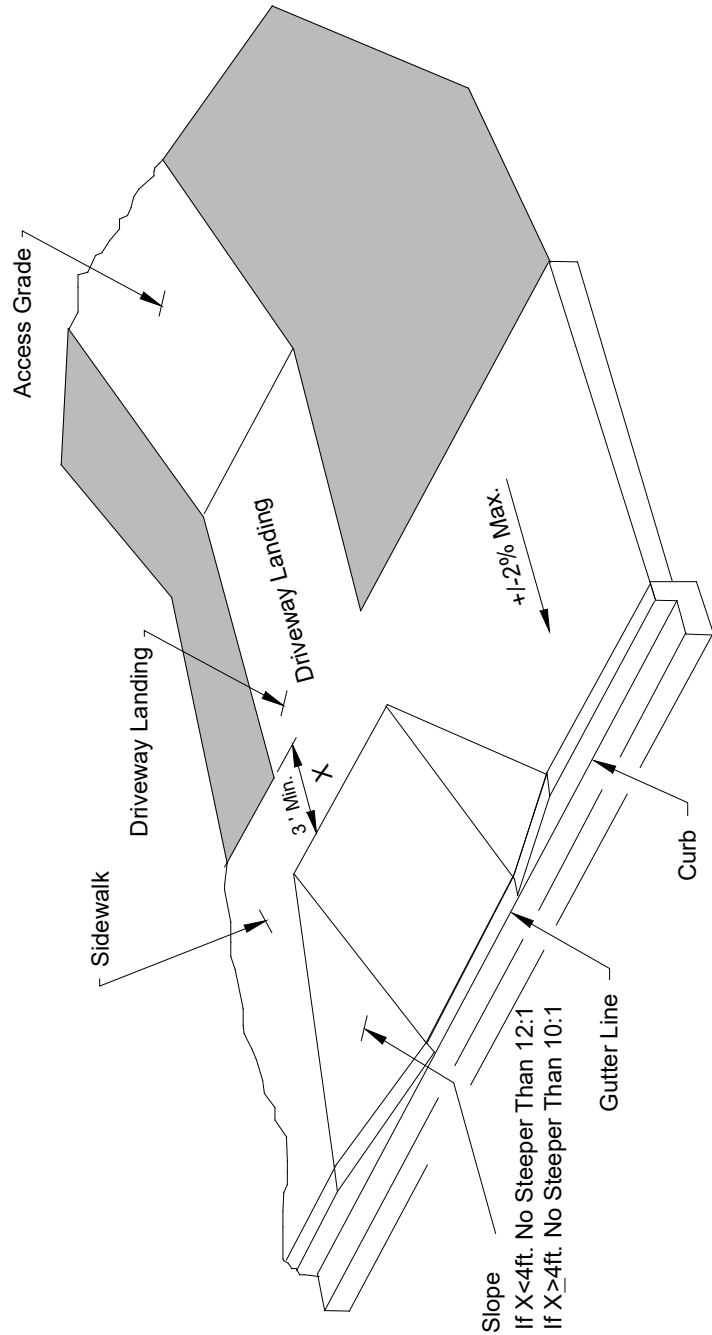
CURB CUT Where Near Level Sidewalk Path (Min 3 ft width & Max 2% X-slope) Can not be constructed

Figure 1190-6a  
Curb Cut Profile



Landing Dimensions	
Usage	Minimum
Passenger Car	10 ft
Semi Tractor Trailer	30 ft

**CURB CUT PROFILE**

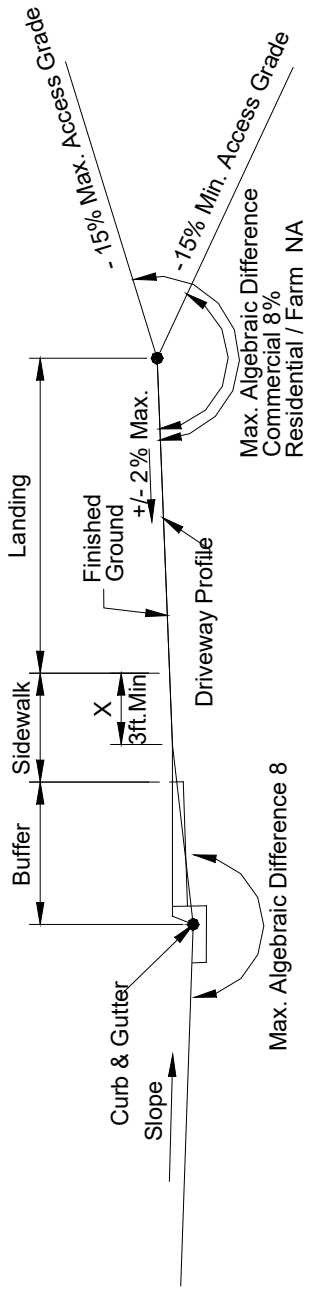


CURB CUT Where Near Level Sidewalk Path (Min 3 ft width & Max 2% X-slope) Can be constructed

**Figure 1190-6b  
Curb Cut Profile**

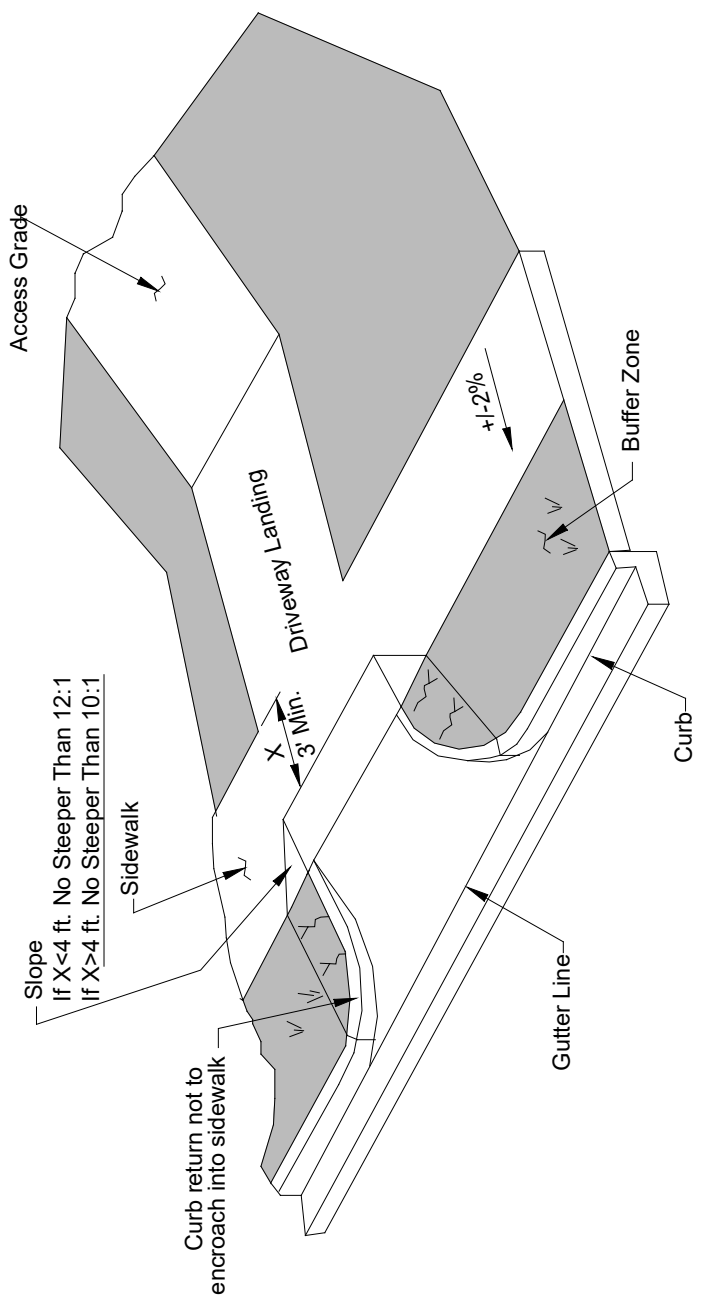






Landing Dimensions	Minimum
Usage	Minimum
Passenger Car	10 ft
Semi Tractor Trailer	30 ft

**CURB CUT PROFILE**



**CURB RETURN CUT** Where Near Level Sidewalk Path (Min 3 ft. width & Max 2% X-slope) Can not be constructed

**Figure 1190-7b  
Curb Cut Profile**

This page intentionally left blank.