

NATIONAL COOPERATIVE HIGHWAY RESEARCH PROGRAM  
REPORT

**279**

# INTERSECTION CHANNELIZATION DESIGN GUIDE

**TIMOTHY R. NEUMAN**  
**Jack E. Leisch & Associates**  
Evanston, Illinois

RESEARCH SPONSORED BY THE AMERICAN  
ASSOCIATION OF STATE HIGHWAY AND  
TRANSPORTATION OFFICIALS IN COOPERATION  
WITH THE FEDERAL HIGHWAY ADMINISTRATION

**AREAS OF INTEREST:**

FACILITIES DESIGN  
OPERATIONS AND TRAFFIC CONTROL  
(HIGHWAY TRANSPORTATION)

**TRANSPORTATION RESEARCH BOARD**  
NATIONAL RESEARCH COUNCIL  
WASHINGTON, D.C.

NOVEMBER 1985

## **NATIONAL COOPERATIVE HIGHWAY RESEARCH PROGRAM**

Systematic, well-designed research provides the most effective approach to the solution of many problems facing highway administrators and engineers. Often, highway problems are of local interest and can best be studied by highway departments individually or in cooperation with their state universities and others. However, the accelerating growth of highway transportation develops increasingly complex problems of wide interest to highway authorities. These problems are best studied through a coordinated program of cooperative research.

In recognition of these needs, the highway administrators of the American Association of State Highway and Transportation Officials initiated in 1962 an objective national highway research program employing modern scientific techniques. This program is supported on a continuing basis by funds from participating member states of the Association and it receives the full cooperation and support of the Federal Highway Administration, United States Department of Transportation.

The Transportation Research Board of the National Research Council was requested by the Association to administer the research program because of the Board's recognized objectivity and understanding of modern research practices. The Board is uniquely suited for this purpose as: it maintains an extensive committee structure from which authorities on any highway transportation subject may be drawn; it possesses avenues of communications and cooperation with federal, state, and local governmental agencies, universities, and industry; its relationship to the National Research Council is an insurance of objectivity; it maintains a full-time research correlation staff of specialists in highway transportation matters to bring the findings of research directly to those who are in a position to use them.

The program is developed on the basis of research needs identified by chief administrators of the highway and transportation departments and by committees of AASHTO. Each year, specific areas of research needs to be included in the program are proposed to the National Research Council and the Board by the American Association of State Highway and Transportation Officials. Research projects to fulfill these needs are defined by the Board, and qualified research agencies are selected from those that have submitted proposals. Administration and surveillance of research contracts are the responsibilities of the National Research Council and the Transportation Research Board.

The needs for highway research are many, and the National Cooperative Highway Research Program can make significant contributions to the solution of highway transportation problems of mutual concern to many responsible groups. The program, however, is intended to complement rather than to substitute for or duplicate other highway research programs.

## **NCHRP REPORT 279**

Project 3-30 FY '83

ISSN 0077-5614

ISBN 0-309-03864-2

L. C. Catalog Card No. 85-51894

**Price \$16.00**

### **NOTICE**

The project that is the subject of this report was a part of the National Cooperative Highway Research Program conducted by the Transportation Research Board with the approval of the Governing Board of the National Research Council. Such approval reflects the Governing Board's judgment that the program concerned is of national importance and appropriate with respect to both the purposes and resources of the National Research Council.

The members of the technical committee selected to monitor this project and to review this report were chosen for recognized scholarly competence and with due consideration for the balance of disciplines appropriate to the project. The opinions and conclusions expressed or implied are those of the research agency that performed the research, and, while they have been accepted as appropriate by the technical committee, they are not necessarily those of the Transportation Research Board, the National Research Council, the American Association of State Highway and Transportation officials, or the Federal Highway Administration, U.S. Department of Transportation.

Each report is reviewed and accepted for publication by the technical committee according to procedures established and monitored by the Transportation Research Board Executive Committee and the Governing Board of the National Research Council.

The National Research Council was established by the National Academy of Sciences in 1916 to associate the broad community of science and technology with the Academy's purposes of furthering knowledge and of advising the Federal Government. The Council has become the principal operating agency of both the National Academy of Sciences and the National Academy of Engineering in the conduct of their services to the government, the public, and the scientific and engineering communities. It is administered jointly by both Academies and the Institute of Medicine. The National Academy of Engineering and the Institute of Medicine were established in 1964 and 1970, respectively, under the charter of the National Academy of Sciences.

The Transportation Research Board evolved in 1974 from the Highway Research Board which was established in 1920. The TRB incorporates all former HRB activities and also performs additional functions under a broader scope involving all modes of transportation and the interactions of transportation with society.

### **Special Notice**

The Transportation Research Board, the National Research Council, the Federal Highway Administration, the American Association of State Highway and Transportation Officials, and the individual states participating in the National Cooperative Highway Research Program do not endorse products or manufacturers. Trade or manufacturers' names appear herein solely because they are considered essential to the object of this report.

Published reports of the

### **NATIONAL COOPERATIVE HIGHWAY RESEARCH PROGRAM**

are available from:

Transportation Research Board  
National Research Council  
2101 Constitution Avenue, N.W.  
Washington, D.C. 20418

## FOREWORD

*By Staff  
Transportation  
Research Board*

Highway designers and traffic planners will find this report of special interest. It is the first guide specifically devoted to intersection channelization design that has been prepared since HRB Special Report 74 was published in 1962. Based on a review of state design manuals, interviews with design and traffic engineers, review of numerous channelization drawings, and operational studies, this report presents a current version of Special Report 74, including illustrative examples of channelization designs and more detailed guidelines than were provided in the earlier report. Design drawings are enclosed as inserts in a pocket on the back cover of the report to facilitate direct use by designers.

---

HRB Special Report 74 was developed for use as a reference guide for traffic engineers and designers concerned with design and operation of at-grade intersections. Its value to the profession, however, has diminished in recent years because of a number of factors. Significant changes in vehicle characteristics, societal values, engineering techniques, as well as continuing research on safety and traffic operations, all have contributed to the need to update that report.

Many state and local agencies had developed their own channelization design criteria (e.g., operational characteristics such as speed and volume) for special intersection conditions including double-turning lanes and free-right turns. However, in most cases, these criteria had not been documented and disseminated for consideration and use by other agencies. The need for a current, comprehensive document describing proven techniques and providing guidelines for the cost-effective design of channelized intersections was paramount.

This report covers channelization of both new and reconstructed intersections in urban and rural environments. The research included typical intersection types such as 4-way, Y, T, oblique, and multileg intersections, as well as freeway ramp intersections with surface streets. Techniques being used to accommodate pedestrians, handicapped, and bicyclists, as well as to reduce vehicular delay and fuel consumption and to enhance safety, were studied. The elements of cost effectiveness, operations, traffic control devices, and maintenance were also addressed. This research was conducted by Jack E. Leisch and Associates under NCHRP Project 3-30.



## CONTENTS

SUMMARY .....	1
CHAPTER ONE Introduction .....	2
Background .....	2
Purpose of Guide and Contents .....	2
CHAPTER TWO Inputs to Design of Channelized Intersections .....	3
Intersections as Points of Conflicts .....	3
User Characteristics .....	3
Operational Characteristics of Intersections .....	8
Other Geometric Features .....	10
Construction Cost Considerations .....	14
Cost Effectiveness .....	15
References .....	15
CHAPTER THREE Design Principles .....	16
Functional Objectives of Channelization .....	16
Principles of Channelization .....	21
CHAPTER FOUR Guidelines for Design of Channelized Intersections .....	40
Number of Legs/Types of Intersections .....	41
Angle of Intersection .....	42
Horizontal and Vertical Alinement .....	44
Warrants/Guidelines for Use of Left-Turn Lanes .....	47
Design of Left-Turn Lanes .....	49
Special Left-Turn Designs .....	52
Exclusive Right-Turn Lanes .....	61
Design of Right-Turn Lanes .....	63
Corner Radius Design .....	66
Design of Turning Roadways .....	69
Traffic Islands .....	69
Access Control and Design of Driveways .....	78
Finalizing the Design .....	83
References .....	83
Additional References .....	86
CHAPTER FIVE Application of Principles and Guidelines to Design of Channelized Intersections .....	88
(Note in the following that references involving foldouts are indicated by the letter F.)	
Intersection 1 .....	90, F
Intersection 2 .....	92, F
Intersection 3 .....	94, F
Intersection 4 .....	96, F
Intersection 5 .....	98, F
Intersection 6 .....	99, F
Intersection 7 .....	100, F
Intersection 8 .....	102, F
Intersection 9 .....	104, F
Intersection 10 .....	106, F
Intersection 11 .....	108, F
Intersection 12 .....	110, F
Intersection 13 .....	112, F
Intersection 14 .....	114, F
Intersection 15 .....	116, F
Intersection 16 .....	118, F
Intersection 17 .....	120
Intersection 18 .....	122
Intersection 19 .....	124

Intersection 20A.....	126
Intersection 20B.....	128
Intersection 21.....	130
Intersection 22.....	132, F
Intersection 23.....	134, F
Intersection 24.....	136, F
Intersection 25.....	F
Intersection 26.....	F
Intersection 27.....	F
Intersection 28.....	138
Intersection 29.....	140
Intersection 30.....	142
Intersection 31.....	143
Intersection 32.....	144
Intersection 33.....	145
Special Case Studies.....	146, F
Intersection 34.....	148, F
Intersection 35.....	150, F
Intersection 36.....	152, F
Intersection 37.....	

## ACKNOWLEDGMENTS

This design guide was developed under NCHRP Project 3-30 by Jack E. Leisch & Associates, Evanston, Illinois. The principal investigator for the research and author of the Design Guide was Timothy R. Neuman. Jack E. Leisch was Project Director. Dr. John C. Glennon of Overland Park, Kansas, served as a special consultant on the project.

The guide could not have been produced without the cooperation and assistance of many people. In particular, we wish to acknowledge the contributions of the following individuals who provided plans and intersection details, and who volunteered many hours of effort in discussion and review of channelization and intersection design: Roger W. Allington, Alaska Department of Transportation and Public Facilities; Robert O. Craigmile, City of Ann Arbor, Michigan; J. D. Barnett, Arkansas State Highway and Transportation Department; Parker Hall, Richard Smith, William Hoverston, California Department of Transportation; William D. McCoy, Georgia Department of Transportation; Elmer Kassens, Idaho Department of Transportation; A. J. Gazda, Illinois Department of Transportation; Robert E. Rebling, Indiana Department of Highways; George F. Sisson, Iowa Department of Transportation; Mark T. Roberts, Kansas Department of Transportation; David M. Groenleer, Kent County (Michigan) Road Commission; Ronald L. Oleson, City of LaCrosse, Wisconsin; Martin G. Buehler, Lake County (Illinois) Highway Department; Harvey D. Shaffer, Louisiana

Department of Transportation; Maurice E. Witteveen, Allen A. Lampela, Michigan Department of Transportation; Wally Marusenko, Minnesota Department of Transportation; Gregory A. Jackson, Terry Copenhaver, Montana Department of Highways; Michael W. McFall, Ronald Hill, Nevada Department of Transportation; Duncan S. Pearson, Gilbert S. Rogers, New Hampshire Department of Public Works and Highways; John H. Datz, New Jersey Department of Transportation; Arthur Perkins, Robert K. Radliff, New York Department of Transportation; E. F. Mallard, W. J. Watson, North Carolina Department of Transportation; G. P. D'Ippolito, E. J. Shaefer, Marion Worley, Ohio Department of Transportation; J. R. Doughty, Pennsylvania Department of Transportation; Pat Alexander, Tennessee Department of Transportation; Mark G. Goode III, Byron C. Blaschke, Texas Department of Highways and Public Transportation; D. D. Harris, Virginia Department of Highways and Transportation; George W. Schoene, Washington, D.C. Department of Public Works; S. A. Moon, Washington Department of Transportation.

Many other engineers from across the country responded to a survey of design practices. Their input was greatly appreciated. The author is particularly indebted to the JEL technical support staff who produced and assembled all materials displayed in this Guide. Finally, special thanks are due the members of the project panel. Their review of progress and suggestions for the design guide were significant contributions.

# INTERSECTION CHANNELIZATION DESIGN GUIDE

## SUMMARY

This report presents the results of research conducted under NCHRP Project 3-30. The objective of this research was to prepare a publication updating the information in *HRB Special Report 74* and incorporating information, illustrations, and guidelines on the current state of the art for channelization. This research covers channelization of both new and reconstructed intersections in urban and rural environments. The research includes typical intersection types such as 4-way, Y, T, oblique, and multileg intersections, as well as freeway ramp intersections with surface streets.

The channelization guidelines presented in subsequent chapters of this report provide specific principles and criteria on the applicability of channelization techniques. In observing the evolution of channelization practices, and reviewing current designs, a number of important points are evident. First and foremost, intersections must be considered as critical highway elements requiring special attention. Geometry adequate for tangent open highway may be inadequate at or near intersections. The importance of driver expectations is heightened on approaches to intersections.

Second, recent experience with "over-channelized" intersections has taught engineers that simplicity in design is highly important. Islands should be kept to the minimum required for the channelization functions of the location. Simple designs are easier to construct, more adaptable to changes in traffic needs, and are understood better by drivers.

Third, one should always be reminded of the important design and operational concerns typical of a given situation. Such concerns can be expressed in terms of the following operational priorities.

### 1. *Operational Priorities For Rural Intersections*

- Provide adequate sight distance on approaches to and clear sight lines at intersections.
- Design all exclusive turning lanes for deceleration from high speed.
- Provide left-turn lanes along primary highways wherever possible.
- Avoid confounding geometry (sharp curves and steep grades) near intersections.
- Produce an intersection that appears consistent with its traffic control.

### 2. *Operational Priorities For Suburban Intersections*

- Provide a design flexible enough to operate under unexpected traffic conditions.
- Retain and design for control of access around major intersections.
- Provide exclusive lane designs that reflect both moderate speeds and high traffic volumes.

### 3. *Operational Priorities For Urban Intersections*

- Maximize approach capacity through judicious use of narrower lanes and various lane arrangements.
- Retain sensitivity to surrounding activities (pedestrians, transit stops, etc.).
- Accommodate and/or control the effects of traffic access adjacent to intersections.
- Design separate turning lanes with sufficient length to enable operation independently of adjacent lanes.

Typical examples of good current practice are documented in the final chapter of this report, including fully dimensioned plan views, photographs, and agency insights to the specific applications (including unique features).

## INTRODUCTION

Design of channelized intersections requires the combined skills of the traffic engineer and the highway engineer. Of particular interest to the traffic engineer are capacity and delay, accident mitigation, vehicle operating characteristics, and appropriate traffic control. The overall layout of the intersection, including horizontal and vertical alignment, cross sectional arrangements, and drainage are specific elements of concern to the highway engineer. All of these features directly relate to design and operation of channelized intersections.

The importance of good design practice for intersections cannot be underestimated. By their very nature, they represent locations of potential safety and/or operational problems.

This publication is a comprehensive collection and evaluation of current knowledge about design of channelized intersections. Its predecessors are *Highway Research Board Special Report 5* (1953) and *Highway Research Board Special Report 74* (1963). In the intervening years, design policies and procedures have evolved in response to changes in vehicle characteristics, traffic problems, societal demands and needs, and constraints. This report thus represents an updated design guide that should be of value to engineers and designers with concern or responsibility for highway intersections.

### BACKGROUND

The design guide is a culmination of research conducted by Jack E. Leisch & Associates under NCHRP Project 3-30. The following research tasks were undertaken:

1. Literature review of the safety and operational aspects of intersections.

2. Survey of design practices of states, cities, and counties.
3. Collection of example intersection designs from design agencies.
4. Field studies of intersections.
5. Interviews with design personnel.
6. Development of design guidelines for channelization.
7. Selection and depiction of example intersections.

The research process was intended to investigate nationwide design practices, thereby discovering both consensus policies and differences in practice. Design guidelines and the example intersections were developed following all interviews and reviews of technical material.

### PURPOSE OF GUIDE AND CONTENTS

No single publication can completely cover the design, operation, and analysis of all types of intersections. This design guide is meant for use as a supplement to prevailing agency standards and policies, and to AASHTO design policies. The intent here is to present in a logical format the functional "bases" or reasons for design of various intersection elements. Through the example intersections and other supplementary material, these functional bases are tied to design, illustrating actual application of channelization principles.

The remainder of this report is organized as follows. Chapter Two presents an overview of the major factors considered in the design of channelized intersections. Chapter Three discusses the principles of design. Guidelines for the design of channelized intersections are discussed in Chapter Four. Example intersections are provided in Chapter Five.



## INPUTS TO DESIGN OF CHANNELIZED INTERSECTIONS

Channelized intersections are similar to other highway elements in that their design involves consideration of many factors. Physical dimensions and operational characteristics of vehicles, roadway approach geometrics, and human factors all contribute to the standards and guidelines that govern design of channelized intersections.

In this chapter, a brief review of those important inputs to channelization design is presented. The reader is referred to referenced publications for more in-depth discussion or further background on the topics presented here.

### INTERSECTIONS AS POINTS OF CONFLICTS

Intersections are intended to operate with vehicles, pedestrians and bicyclists proceeding in many directions, often at the same time. At such locations, traffic movements on two or more facilities are required to occupy a common area. It is this unique characteristic of intersections—the repeated occurrence of conflicts—that is the basis for most intersection design standards and criteria, and proper operating procedures.

Understanding conflicts—why they occur, what their consequences are, how to safely accommodate them—is the key to good design of intersections. *Conflict* is defined here as a demand for the same highway space by two or more users of the highway. While conflicts occur on all highways, their frequency and wide variance in type and nature is a particularly critical aspect of intersections.

Consider Figure 2-1, which illustrates the basic conflict types that occur at intersections. *Crossing* conflicts are unique to intersections, and are generally the most important type. *Diverging* conflicts are created by vehicles making turning movements or lane changes. *Merging* conflicts result from the completion of such turning movements.

As Figure 2-1 shows, the essence of design can be viewed as achieving safe and efficient resolution of conflicts that are inherent to intersections. Conflict situations left unresolved can lead to erratic maneuvers such as hard braking or unsafe lane changing, long delays, and other undesirable occurrences. Ultimately, such situations produce accidents which, depending on the circumstances, can lead to loss of life and serious injury.

Conflict resolution primarily involves (1) providing sufficient notice to the driver of a potentially dangerous conflict, and (2) easing the driving task by spacing out conflicts over time or by eliminating conflicts. In both instances, the importance of time and, hence, vehicle speed is central to conflict resolution. Good design reflects prevailing speeds and required times for the complex decisions and reactions required of drivers at intersections. Indeed, because such reactions include deceleration and braking, not only speed is important, but also speed changes. Channelization and intersection design are closely tied to the require-

ments of vehicles undergoing significant speed changes, as well as to requirements of other drivers who must react to these speed changes.

Of course, the type of traffic control at an intersection is also vitally important to resolution of conflicts. Traffic control devices, such as stop and yield signs and traffic signals, resolve certain types of conflicts by separating conflicts demands for space by time. However, this separation also creates conflicts associated with the speed changes and braking that are produced by the traffic control. Clearly, resolution of all conflicts requires coordination of the geometry and channelization with the type of traffic control.

Finally, as is true of all design problems, conflict resolution through channelization must reflect many constraints. These include costs and ease of implementation, maintenance needs, and environmental conditions. Such constraints affect the design standards and practices that generally prevail, as well as their implementation at any given location.

### USER CHARACTERISTICS

From the previous discussion, it is clear that human factors considerations are extremely important at intersections. Also, certain physical and operational characteristics of vehicles are demonstrably a part of intersection design. In this section, a brief review of these elements is presented.

#### Human Factors

The driving task on approach to and at an intersection is extremely complex, including a number of factors. *Navigation* involves the selection of the proper lane on roadways. *Maneuvering*, the actual task of placing the vehicle in its proper position, also must be considered. *Perception* of conflicting traffic or of the traffic control in effect is another driving task. *Reaction* to imminent events requiring acceleration, deceleration, braking or avoidance is particularly important. *Gap acceptance* to perform crossing or merging maneuvers with conflicting traffic streams is a particularly complex task, involving elements of all of the foregoing factors. The combination of all such tasks creates the potential for task overload, i.e., a condition in which the driver is unable to safely process and react to all important conditions. Avoiding task overload through good signing is important. It involves awareness of basic driver expectancies.

The concept of *driver expectancy* is a key to handling all of the above driving tasks within the context of intersection design. Drivers expect and to a degree anticipate certain geometric and operational situations at intersections. The channelization scheme and traffic control should as a minimum avoid violating

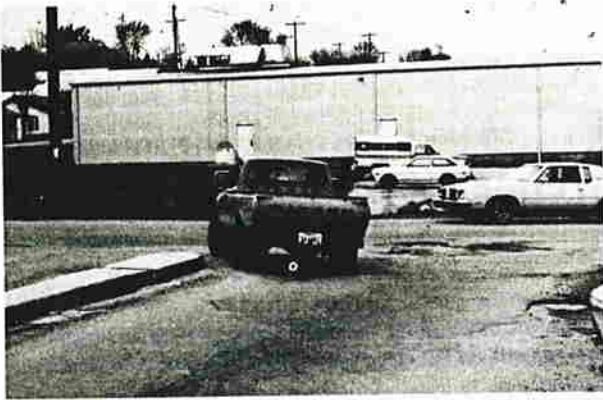

Crossing conflicts are also created by left turning vehicles.

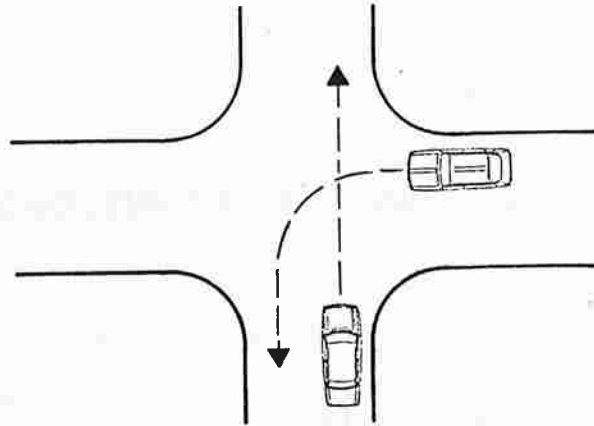

CROSSING CONFLICTS



Merging conflicts are created by right- or left-turning vehicles that interact with traffic on the departure leg.

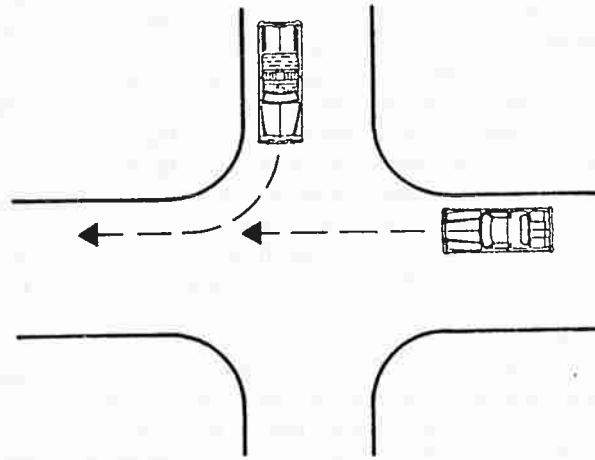

MERGING CONFLICTS

Figure 2-1. Basic conflict types at intersections.



Crossing vehicle paths occur at all 4-leg intersections. Crossing conflicts are also created by pedestrian activity within the traveled way.

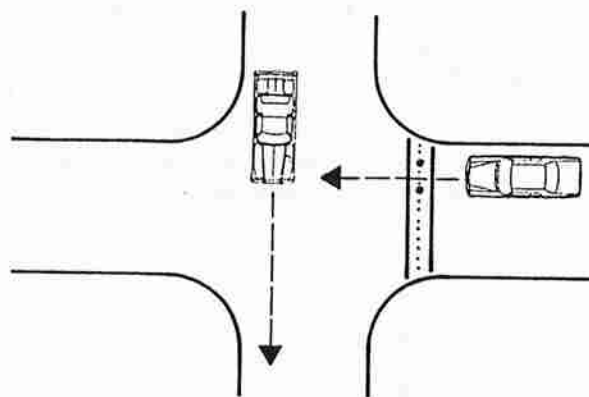

CROSSING CONFLICTS



Turning maneuvers usually require speed adjustments, resulting in rear-end or diverging conflicts with following vehicles.

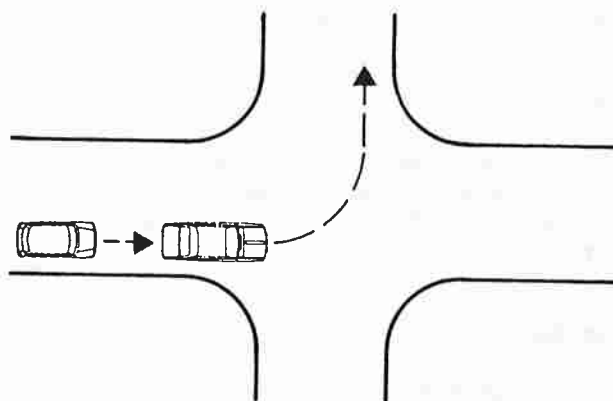

DIVERGING CONFLICTS

*Figure 2-1. Continued*

driver expectations, and should desirably reinforce these expectations. Table 2-1 describes application of driver expectancy to channelization design.

Certain specific human characteristics are related directly to design standards. These primarily involve driver abilities to perceive and respond to stimuli. Table 2-2 summarizes relevant human factors and their design relationships.

### Vehicle Characteristics

Vehicle characteristics also play a significant role in channelization design. Table 2-3 describes the particular vehicle characteristics related to intersection design elements.

In terms of design, the physical dimensions and their operational characteristics of vehicles affects intersections. Minimum and desirable lane widths, turning roadway widths and storage lane lengths are a function of the vehicle population mix and individual vehicle characteristics. Operational characteristics (acceleration, deceleration, minimum turning radius) affect the design of exclusive lanes, tapers, turning roadways, and corner islands.

Traditional design practice relies on designated "design vehicles" the characteristics of which are selected to model a particular or critical segment of the vehicle population. Figure 2-2 depicts AASHTO design vehicles that are used in intersection design. Minimum turning radii, swept path width, and vehicle dimensions are shown for each vehicle.

Figure 2-3 shows relevant vehicle operational characteristics used in intersection design. These include vehicle acceleration, deceleration, and braking characteristics.

### Environmental Factors

Design of an intersection must be sensitive to a number of environmental factors. The type of highway and area, surrounding land use, and local climate all influence the type of design that is reasonable.

### Type of Highway

Functional classification is a major consideration in application of channelization principles and design standards. Major arterials and other high classified facilities tend to carry higher traffic volumes, operate at higher speeds, and are used by greater numbers of occasional or first time (i.e., unfamiliar) drivers. They also tend to be used by greater proportions of large trucks and buses. In addition, driver expectations on such highways are greater. Drivers anticipate good route continuity and a high level of service.

Intersections along such highways should reflect their operating characteristics of drivers and their expectations. Channelization should accommodate large vehicles in a simple, direct manner. Decision sight distance is an important element, and route signing and pavement markings should be clear and direct.

### Area Type and Land Use

Intersection activity is largely dependent on the type of area and adjacent land use. In highly developed urban areas, pedes-

**Table 2-1. Human factors relationships with intersections.**

DRIVER EXPECTANCY AND INTERSECTION ELEMENTS
<ul style="list-style-type: none"> <li>• Avoid lane traps (exclusive turn-lanes) on through roadways or lanes.</li> <li>• Provide decision sight distance on approaches to major intersections.</li> <li>• Maintain consistency in appearance of intersection and its traffic control.</li> <li>• Maintain consistency in design treatment of elements such as turn-lanes, islands, etc.</li> <li>• Maintain consistency in traffic control schemes</li> </ul>
TASK OVERLOAD AND INTERSECTION ELEMENTS
<ul style="list-style-type: none"> <li>• Avoid confounding alinement (i.e., sharp horizontal curves, steep grades) in conjunction with intersections.</li> <li>• Provide adequate distance and taper design for lane drops past intersections.</li> <li>• Provide recovery areas past departure of exclusive turn-lanes.</li> <li>• Provide adequate sight distance commensurate with traffic control.</li> </ul>

**Table 2-2. Human factors values appropriate for intersection design.**

HUMAN FACTOR	DESIGN VALUES	DESIGN ELEMENTS AFFECTED
Perception/reaction time	2.0 <sup>a</sup> -4.0 <sup>b</sup> sec	Intersection sight distance
Driver height of eye	3.5 ft <sup>a</sup>	Sight distance
Pedestrian walk times	3.0-4.5 fps <sup>c</sup>	Pedestrian facilities

<sup>a</sup> Source: Ref. 2-1

<sup>b</sup> Source: Ref. 2-2

<sup>c</sup> Source: Refs. 2-2, 2-3

**Table 2-3. Vehicle characteristics applicable to design of channelized intersections.**

VEHICLE CHARACTERISTICS	INTERSECTION DESIGN ELEMENTS AFFECTED
<i>Physical Characteristics</i>	
Length	• Length of storage lanes
Width	• Width of lanes
	• Width of turning roadways
Height	• Placement of overhead signals and signs
<i>Operational Characteristics</i>	
Wheelbase	• Nose placement
	• Corner radius
	• Width of turning roadway
Acceleration capability	• Acceleration tapers and lane lengths
Deceleration and braking capability	• Length of deceleration lanes and tapers
	• Stopping sight distance

trian volumes, on-street parking, and transit bus activity are normal. In suburban residential areas, bicycle and school pedestrian activity may be important. Rural areas usually are associated with motor vehicle traffic, and little bicycle and pedestrian traffic.

### Climate

Designers should be aware of operational and cost constraints imposed by variable climatic conditions. Regular snowfalls can

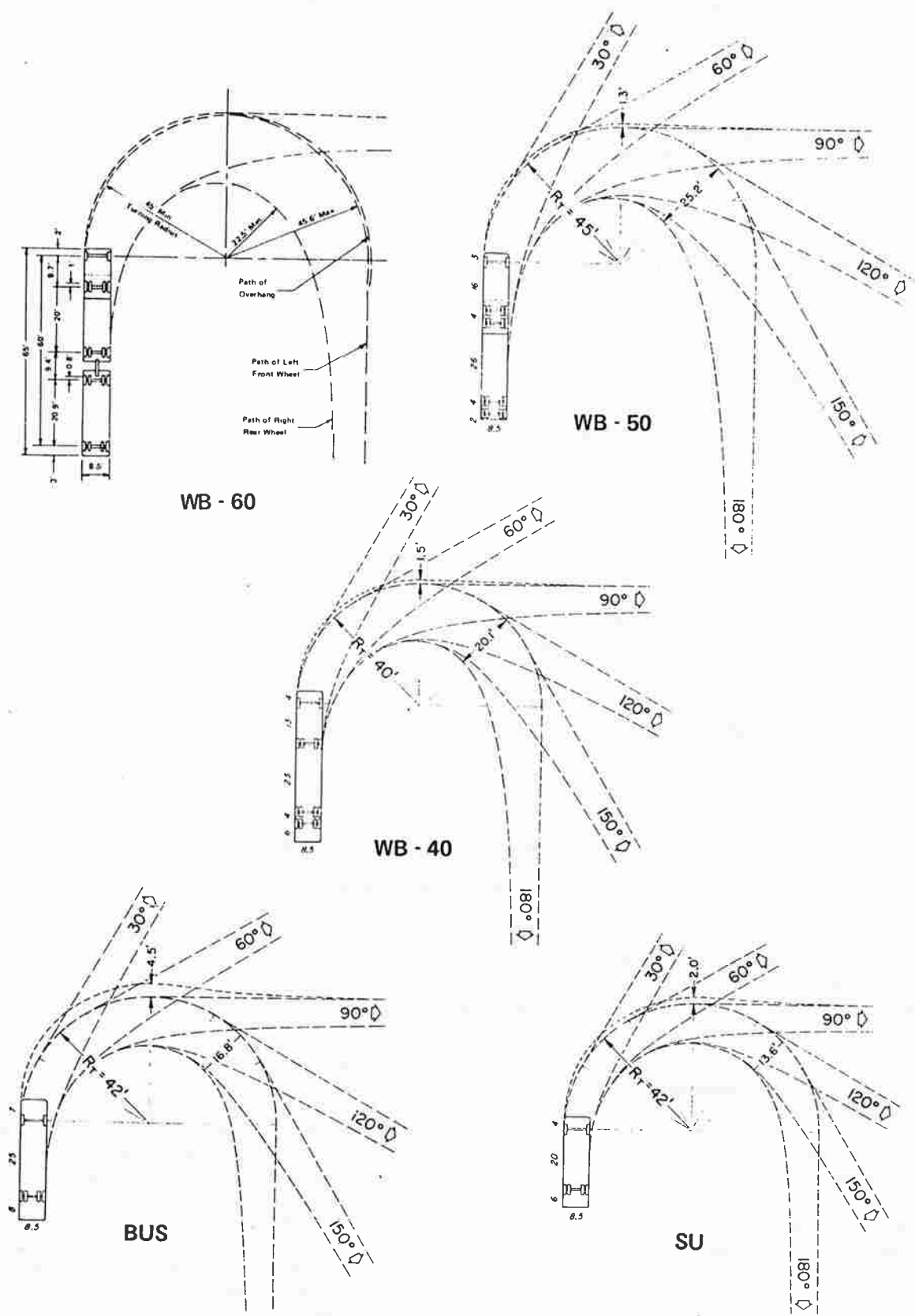
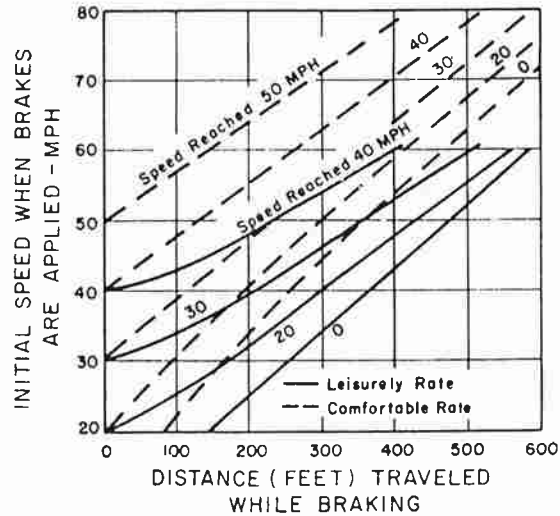
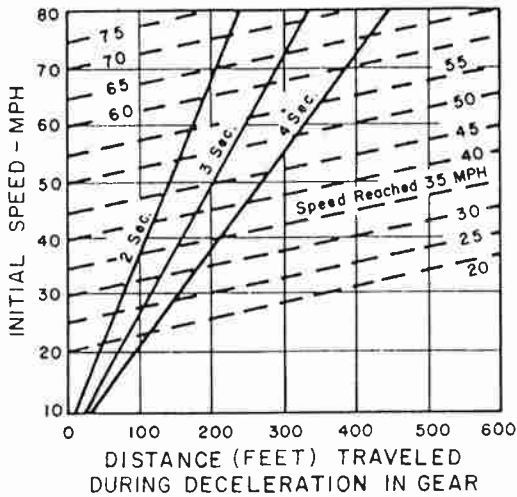
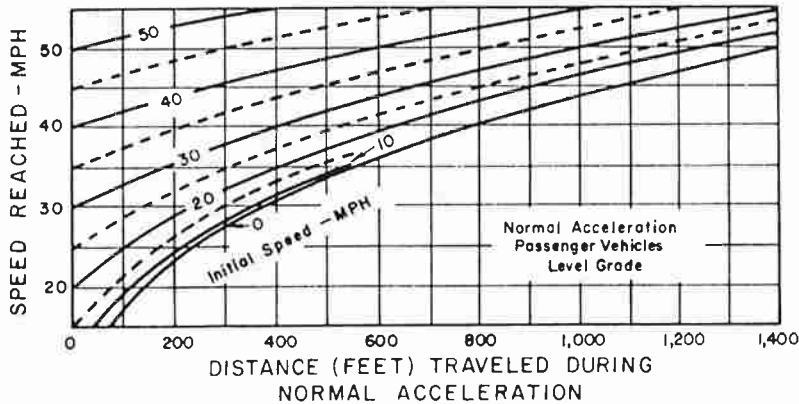

Figure 2-2. Vehicle characteristics affecting intersection design—turning radii and offtracking for minimum turns of AASHTO design vehicles.



### DECELERATION CHARACTERISTICS



### ACCELERATION CHARACTERISTICS

Figure 2-3. Vehicle characteristics affecting intersection design—acceleration and deceleration of passenger cars. (Source: Ref. 2-1)

obscure some channelization. In addition, ease of snow removal is affected by an intersection's design. The visibility of pavement markings can also be severely limited by rain or poor light conditions.

#### OPERATIONAL CHARACTERISTICS OF INTERSECTIONS

The basic conflict nature of intersections creates a unique set of operational characteristics. Understanding these basic intersection operational characteristics is central to an appreciation of channelization principles and design guidelines. In particular, both safety (frequency, types and severity of accidents), and capacity considerations are important.

#### Intersection Accidents

Figures 2-4 through 2-7 summarize the basic characteristics of intersection accidents. In general, traffic volume is the single

most important determinant in intersection accidents. This is logical, because the potential for accidents created by conflict situations greatly increases as traffic on both highways increases. Also, the type of traffic control is of great significance. Signalized intersections tend to experience more rear-end and same direction sideswipe accidents than stop-controlled intersections. Stop-controlled intersections experience greater frequencies of angle or crossing accidents, because of the less positive form of control.

There are many other features that contribute to accidents at intersections. Reviews of research and the survey of practicing engineers produce useful findings for designers. As Table 2-4 shows, many geometric features or conditions that can create particularly hazardous situations have been successfully treated through various geometric and control measures. The features given in Table 2-4 are covered in greater detail in Chapter Four on design guidelines.

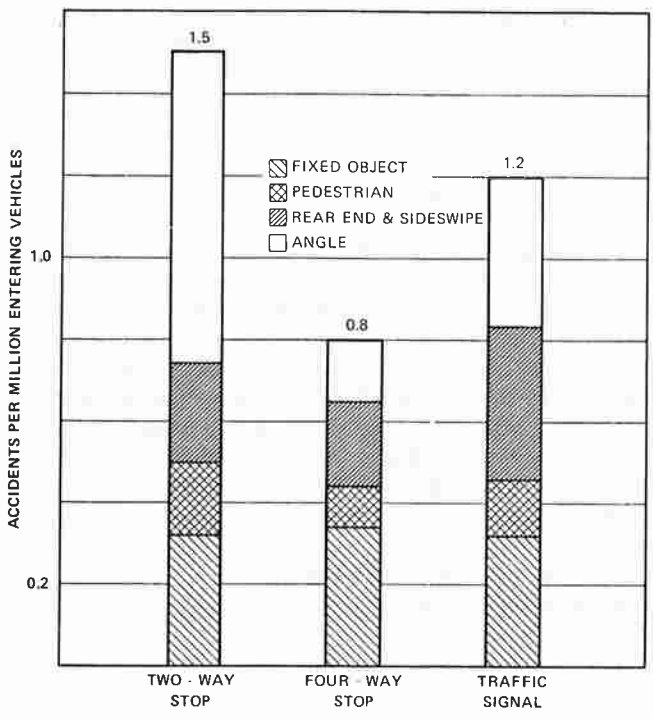

Figure 2-4. Types and rates of accidents at intersections. (Source: Ref. 2-4)

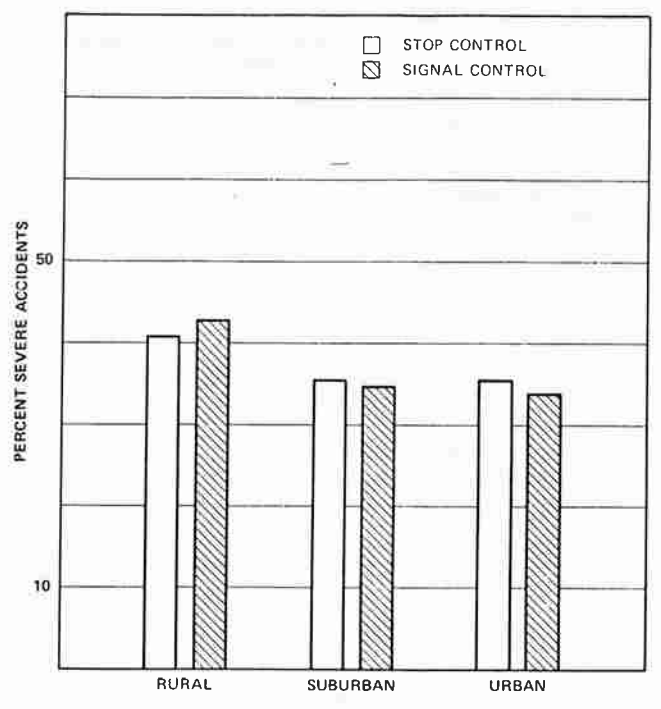

Figure 2-5. Severity of accidents at intersections. (Source: Ref. 2-5)

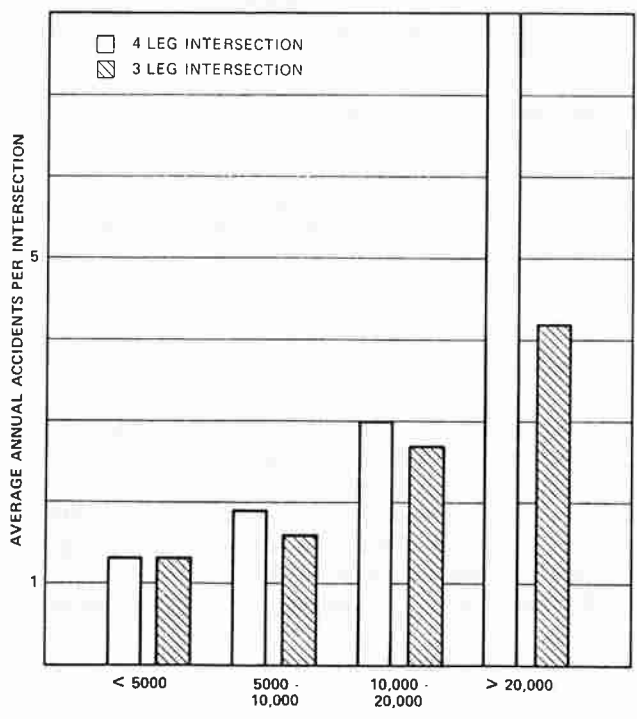

Figure 2-6. Effect of traffic volume and geometry on accidents at intersections. (Source: Ref. 2-6)

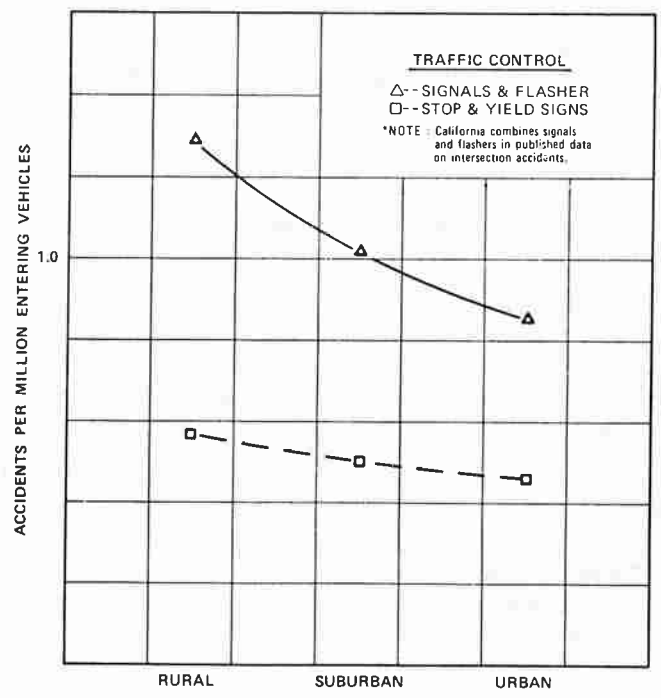

Figure 2-7. Accident rates at intersections by area and type of traffic control. (Source: Ref. 2-5)

**Table 2-4. Features contributing to accidents at intersections and control measures (as noted by design and traffic engineers responding to a survey of intersection channelization practices).**

*Geometric Features or Conditions Contributing to Adverse Accident Experience at Intersections*

- Poor approach sight distance
- Poor corner sight distance
- Steep grades at intersections
- Inappropriate traffic control
- Multiple approaches
- Presence of curves within intersection
- Number of adjacent driveways or access points
- Inappropriate curb radii
- Narrow lanes

*Traffic Engineering Actions That Reduce Accident Experience or Severity*

- Addition/installation of exclusive turn-lanes
- Upgrading of traffic control scheme
- Improving sight distance
- Installation of lighting
- Removal of fixed objects
- Increasing corner radii

### Intersection Capacity Considerations

A basic design control is provision for adequate capacity to handle peak period traffic demands. Intersection capacity analyses are based on the operational characteristics of conflicting vehicles sharing the same space, but separated by time via the type of traffic control. A brief summary of capacity considerations related to design follows.

#### *Signalized Intersections*

Capacity of signalized intersections is based on the discharge characteristics of vehicles queued at signal. Driver reaction, vehicle acceleration, and car following behavior all affect the saturation flow rate of the intersection. The capacity of an approach is given by:

$$\text{Capacity} = C = S(g/c)$$

where  $S$  is the saturation flow rate (in vehicles per hour of green time) and  $g/c$  is the ratio of approach green time to total cycle time.

In terms of design, it is important to note those factors that influence saturation flow rate:

- Number of lanes.
- Width of lanes.
- Presence of heavy vehicles.
- Presence of grades.
- Presence of parking.
- Amount of pedestrian activity.
- Signal phasing plan.

In terms of capacity, the need for, and design of, exclusive turning lanes is critical, as is the total number of lanes on each approach.

Figure 2-8 illustrates the basic considerations important to evaluation of signalized intersection capacity. Reference 2-7 should be consulted for detailed discussion and analysis procedures.

#### *Unsignalized Intersections*

The operation of unsignalized intersections is completely different, with resulting different capacity considerations. Unsignalized intersections operate with distinct priority movements, as shown in Figure 2-9. The crucial capacity concerns are generally centered around the lower priority (i.e., stopped) approaches or movements. Capacity analysis procedures are based on expected distribution of gaps in through (unstopped) traffic, and driver behavior regarding acceptance of those gaps. Factors that affect the capacity (i.e., that influence amount of delay) of stopped approaches include:

- Prevailing speed of through highway.
- Available sight distance.
- Corner radius design.
- Arrangement of lanes.
- Type of area.
- Presence of heavy vehicles.

In terms of channelization, provision for adequate sight distance and unblocked sight lines is very important on stopped approaches. Also, arrangement of lanes is a significant factor. As Figure 2-9 shows, right-turn movements operate more freely (with a high priority) than left and through movements. Hence, it is generally advantageous to separate right-turn movements wherever possible at STOP- or YIELD-controlled intersections.

Reference 2-7 presents a more complete discussion of unsignalized intersection capacity. It should also be referred to for analysis procedures and guidelines.

### OTHER GEOMETRIC FEATURES

Intersection design must be considered in relation to the other geometric features that comprise the highway. Horizontal and vertical alignment and cross sectional features affect driver/vehicle behavior at and on the approach to the intersection, and therefore are important design considerations.

#### **Horizontal Alinement**

Special care should be taken in designing intersections near horizontal curves. The driving task of tracking the curve takes up much of the driver's attention, leaving less for conflict resolution. Also, vehicle cornering friction demands associated with curves reduce the amount of friction available for braking. Figure 2-10 demonstrates this problem, which results in greater actual safe stopping distance requirements for vehicles braking on curves.

#### **Vertical Alinement**

Vehicle operating characteristics are greatly influenced by vertical alignment. Approaches on upgrades operate at lower





*Approach capacity is largely a function of the number and arrangement of lanes.*



*Saturation flow rates are based on discharge headways of vehicles queued at an approach.*



*Unusual geometry such as this multi-leg intersection adversely affects intersection capacity.*



*The presence of large vehicles and ease of their movements also affects approach capacity.*



*The presence of pedestrians affects both right turn movements and signal phasing requirements.*



*The signal phasing plan influences approach and total intersection capacity.*

*Figure 2-8. Illustrations of capacity concepts at signalized intersections.*



*Capacity of stopped or low priority approaches is a function of acceptance of gaps in through traffic.*



*Left turns off unstopped approaches must await gaps in opposing traffic to complete the turn.*

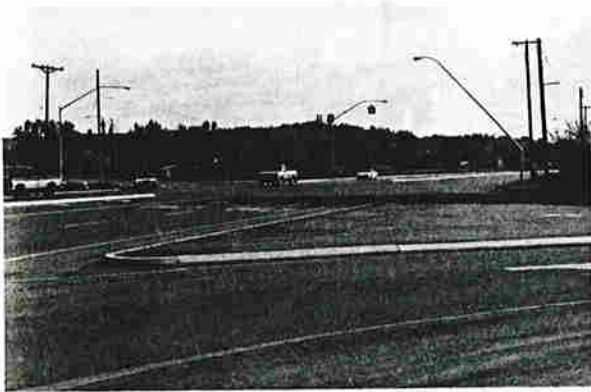

*Gap acceptance is influenced by speed of through traffic and the width to be crossed.*



*Right turn movements are generally easier than through and left turns, as traffic from the right does not interfere with the turn.*



*Poor corner sight distance can adversely affect gap acceptance and stopped approach capacity.*



*Delay to stopped approaches is the basis for level of service definitions.*

*Figure 2-9. Illustrations of capacity concepts at unsignalized intersections.*

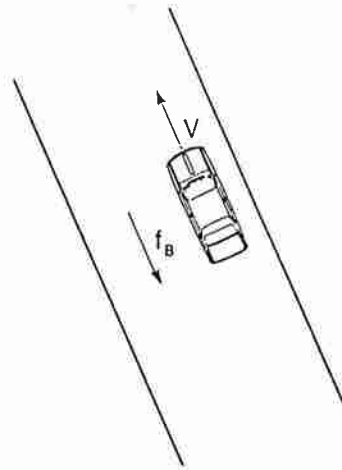

## BRAKING ON LEVEL TANGENTS

$$d_B = \frac{V^2}{30 f_B}$$

Where  $d_B$  = Braking distance (ft)  
 $V$  = Initial speed (mph)  
 $f_B$  = Coefficient of friction available for braking  
 (AASHTO design values assumed)

## BRAKING ON LEVEL CURVES

$$d_B = \frac{V^2}{30 f_B'}$$

Where  $d_B$ ,  $V$ ,  $f_B$  as above

$f_B'$  = Coefficient of friction available for braking  
 on curves

$$\text{and } f_B' = \sqrt{f_B^2 - f_C^2}$$

$$f_C = \frac{V^2}{15R} - e$$

Where  $f_C$  = Coefficient of side friction required for cornering  
 (AASHTO design values assumed)

$R$  = Radius of curve (ft)

$e$  = Superelevation (m/m)

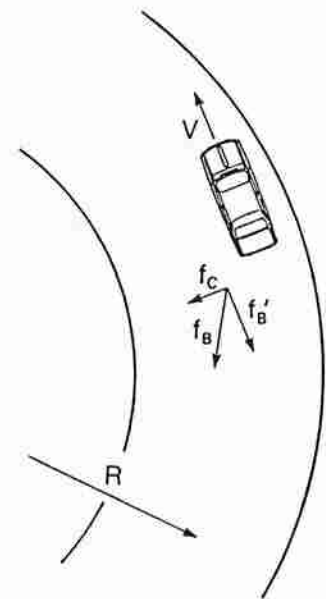

Figure 2-10. Friction requirements for stopping on horizontal curves. (Source: Ref. 2-8)

capacities, because discharge flow rates are lower due to poorer acceleration capabilities. On downgrades, braking requirements increase. Vertical curves (their location and length) directly influence the amount and location of restrictions to stopping sight distance.

### Cross Section

Roadway widths and roadside design characteristics can significantly influence intersection operations. In urban areas, the frequency and consequences of many width-related features can affect nearby intersection conflicts. On rural highways, availability of shoulders for turning vehicles or for lessening the possible adverse effects of bicycles is important.

### Sight Distance

Sight distance, created by all the geometric elements of the highway, is among the most significant characteristics associated

with intersections. There are three types of sight distance relevant to intersections. These are corner sight distance, stopping sight distance, and decision sight distance.

#### Corner Sight Distance

The ability to safely accelerate from a stopped position and cross conflicting traffic is a necessary feature of intersections. Clearly, sight line vehicle characteristics, prevailing speeds, and crossing distance all determine minimum sight distance "at the corner." Figure 2-11 illustrates this concept. Providing sufficient sight distance at stopped or uncontrolled approaches is accomplished through profile design, clearing of sight triangles in each quadrant of the intersection, and adjusting the location and angle of intersection.

#### Stopping Sight Distance

Safe minimum stopping sight distance is necessary at all points

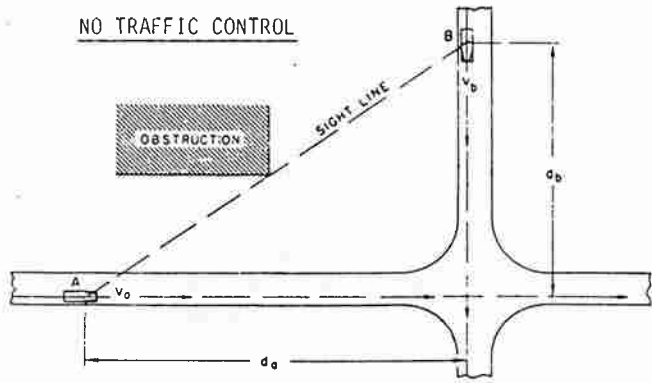

Clear sight lines must be available on both approaches

- Desirable Condition--Safe Stopping Sight Distance (Perception, Reaction and Braking from Design Speed)
- Minimum Requirement--Notice to Each Driver (3 seconds) For Collision Avoidance

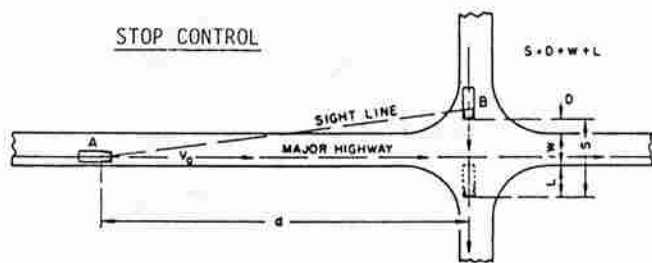

Stopped traffic must have sufficient sight distance to safely depart from a stopped condition.

- Desirable Condition--Left Turn Departure That Does Not Significantly Disrupt Major Street Traffic
- Minimum Condition--Safe Crossing Departure For Large Trucks

SIGNAL CONTROL

Corner Sight Distance Desirable But Not Required

Figure 2-11. Corner sight distance concepts.

on the highway. It is particularly critical on the approaches to intersections. Designers should note that available sight distance varies along a change in horizontal and vertical alinement. Stopping sight distance profiles, shown in Figure 2-12, are useful in evaluating locations of minimum sight distance. Wherever possible, design of the alinement and location of the intersection should consider these areas of minimum sight distance. It is best to avoid placing an intersection within the region of minimum stopping sight distance.

*Decision Sight Distance*

Decision sight distance is the distance required for a driver to (1) detect an unexpected or difficult to perceive information source; (2) recognize the potential hazard or opportunity; (3)

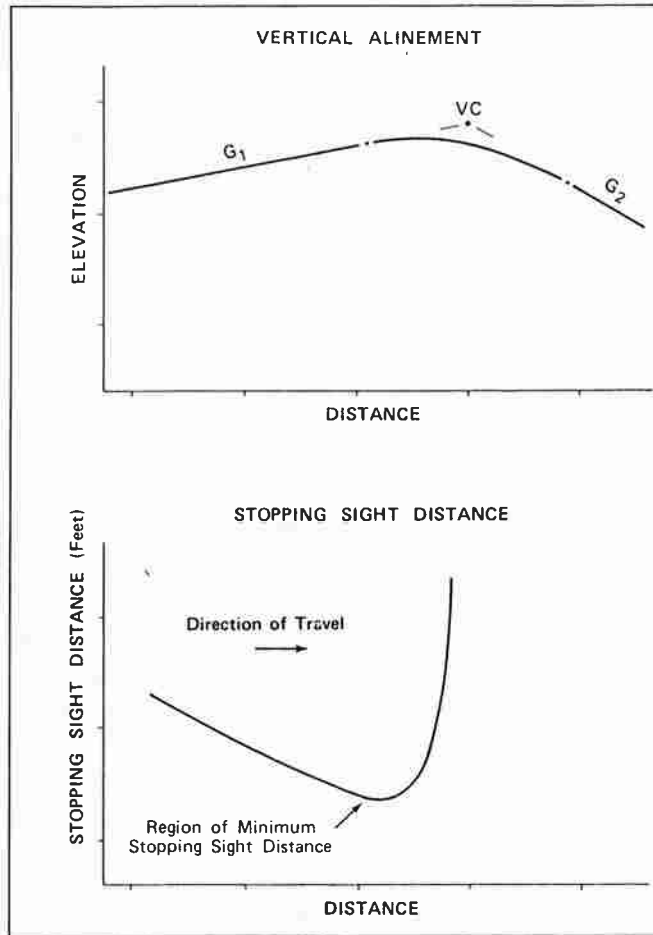

Figure 2-12. Stopping sight distance profile.

select an appropriate speed and/or path; and (4) initiate and complete the selected maneuver. Major, high-speed intersections, particularly involving route turns or junctions, represent important navigational points for drivers. Decision sight distance, which includes that distance sufficient for perception and navigation, should be provided on approaches to major intersections.

**CONSTRUCTION COST CONSIDERATIONS**

Channelization can involve a wide range of improvements and their respective costs. Complete reconstruction or new construction, including earthwork, pavement and curb, and traffic signals can require significant expenditures. Minor channelization improvements such as lane additions, construction of islands, or improved radius design can be relatively inexpensive. Some effective channelization treatments, designed within existing roadways, have nominal cost. These may include island removal, rechannelization using pavement markings or redesigned islands and sign/traffic signal upgrading.

Table 2-5 presents illustrative or representative costs of a range of intersection-related improvements. The list was compiled from recently completed or bid projects nationwide.

## COST EFFECTIVENESS

Cost effectiveness of a particular channelization improvement is highly dependent on the type of improvement, local traffic conditions, and its cost. Investment in new turning lanes, realignment, rechannelization, etc. largely depends on expected improvement in a location's accident history, operating costs and delay, or both. In general, the greatest cost effectiveness is achieved by improvements that reduce frequencies of severe accidents (angle, head-on, high-speed rear end, pedestrian-involved). Channelization design improvements that typically address such problems include addition of separate turning lanes, limitations in or control of access, upgrading of traffic control, and improvements to sight distance or driver sight angles. Design agencies should monitor the effects of their intersection improvements to provide assistance in future decision-making.

## REFERENCES

- 2-1. American Association of State Highway and Transportation Officials. *A Policy on Geometric Design of Highways and Streets* (1984).
- 2-2. *Traffic Engineering for Senior Citizen and Handicapped Pedestrians*. Prepared by Multi-Agency Study Committee in the State of Minnesota (Aug. 1983).
- 2-3. Institute of Transportation Engineers, *Transportation and Traffic Engineering Handbook* (1976).
- 2-4. EBBECKER, G. M., and SCHUSTER, J. J., "Areawide Impact of Traffic Control Devices." *Transportation Research Board Record 644* (1975).
- 2-5. California Department of Transportation Statewide Accident Summaries.
- 2-6. DAVID, N. A., and NORMAN, J. R., "Motor Vehicle Accidents in Relation to Geometric and Traffic Features of Highway Intersections, Volume II—Research Report." *Report No. FHWA-RD-76-129* (July 1979).
- 2-7. "Highway Capacity Manual." *Transportation Research Board Special Report 209* (1985).
- 2-8. NEUMAN, T. R., ET AL. "Functional Analysis of Stopping-Sight-Distance Requirements." *Transportation Research Board Record 923* (1983).

Table 2-5. Representative costs of channelization and intersection design projects (1983 costs).

TYPE OF PROJECT	CONSTRUCTION COST (\$)
New major signalized intersection	Variable—up to 3 million
New unsignalized intersection	250,000–350,000
Widening and new channelization	100,000–150,000
Installation of new traffic signals	60,000–100,000
Reconstruction of one approach	50,000–75,000
Construction of new turning lanes	10,000–20,000
Realignment of curb	10,000

## CHAPTER THREE

**DESIGN PRINCIPLES**

Intersection design must begin with the same objectives basic to all highway design. These are two-fold:

1. The design and traffic control scheme should optimize the operational quality of traffic flow through the intersection.
2. The intersection should be designed to minimize accidents and their adverse consequences.

In terms of intersections, operational quality refers primarily to level of service and delay, and comfort and ease of navigation. Safety concerns relate not only to accident frequency, but also to severity of accidents. Good design thus is seen as producing an intersection that is easily traversed by unfamiliar drivers, that produces minimal delays for all users, and that is as safe as is practicable.

With both basic objectives, it is extremely important to recognize the unique characteristics of intersections. They are intended to operate as locations where vehicles traveling in opposing or conflicting directions must share space. Also, the route or path choices available to drivers are inherently much greater than on other highway sections.

**FUNCTIONAL OBJECTIVES OF CHANNELIZATION**

Clearly, the relationship between meeting the basic objectives and intersection design is in dealing with conflicts. In other words, achieving safe, efficient operations must be within the context of managing the conflicts that are inherent to intersections. With this in mind, a more useful refinement of basic design objectives is offered for channelization of intersections.

It is the objective of good intersection design and traffic control to achieve the following:

1. The number of points of potential conflict should be reduced to the minimum required for efficient operation.
2. The complexity of conflict areas should be reduced whenever possible.
3. The frequency of actual conflicts should be limited.
4. The severity of conflicts that do occur should be limited.

These four functional objectives are illustrated on the following pages.

The first objective translates the basic operational objective to a meaningful one for intersections. Complex intersections are difficult to operate efficiently, create confusion for unfamiliar drivers, and should therefore be avoided. The second objective contains elements of both operational quality and safety. Each point of conflict represents a potential source of delay or, in the extreme, a potential accident. The third and fourth objectives primarily relate to safety. Recognizing that points of conflict are necessary at intersections, it is desirable to mitigate their adverse effects. This includes reducing the chances that a conflict will occur, and given that one occurs, reducing the consequences of it.

The four functional objectives thus form the basis for intersection and channelization design concepts. Translating these objectives into design principles entails analysis of traffic operational problems characteristic of intersections. Years of experience and observations, through both formal research and day-to-day, working knowledge of problems and their solutions, reveal the following:

- Many intersection operational problems are caused by a concentration of activities within a very small area. Drivers forced to contend with rapid, multiple decisions are prone to error. Their actions (braking, erratic maneuvers) impact other drivers, further aggravating the situation.
- Intersections generally require adjustments in vehicle speeds for their safe operation. Deceleration and braking for traffic control to effect turns or to avoid conflicts are necessary for most drivers who enter the intersection. These speed adjustments themselves create opportunities for driver error and conflict, as they require other drivers to perceive and react to them.
- Inattentive, unfamiliar, or less capable drivers can significantly affect intersection operations. Sudden lane changes or braking and inappropriate approach speeds create potential safety problems. The number of route opportunities provided by intersections increases the chances of any driver making an improper or unsafe maneuver.

These "characteristic problems" of intersections are central to application of the functional objectives of channelization.

**FUNCTIONAL OBJECTIVE OF CHANNELIZATION—**  
Limitation of Points of Conflict.

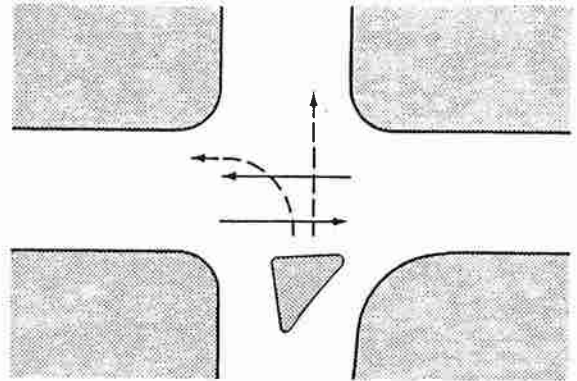

*Prohibition of through and left turn movements by physical channelization reduces the number of crossing points.*

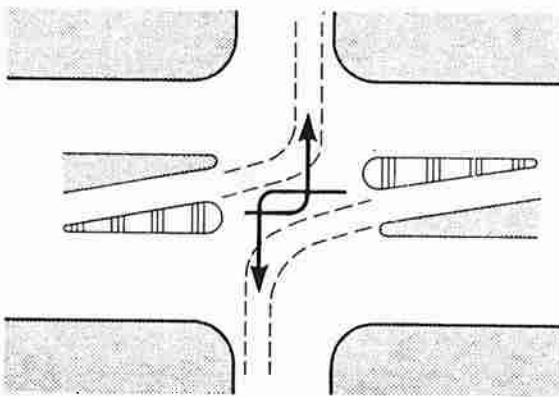

*Separation of opposing left turn lanes eliminates the potential conflict point involving the overlapping paths of left turning vehicles.*

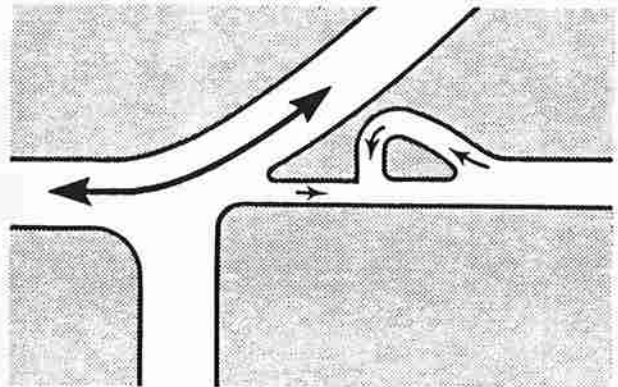

*Prohibition of traffic entering an intersection on one approach eliminates many potential conflict points with the through facility.*

**FUNCTIONAL OBJECTIVE OF CHANNELIZATION—**  
Limitation of Conflict Area Complexity

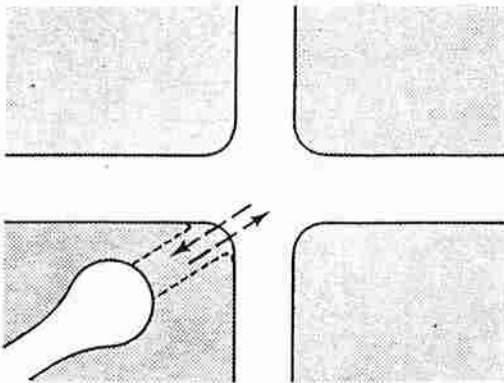

*Elimination of multi-leg intersections through street closures greatly simplifies the operation of the intersection.*

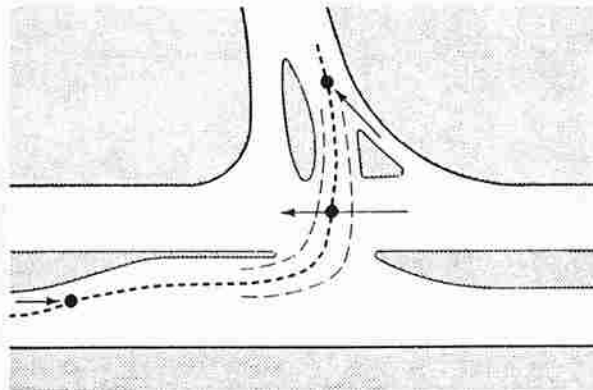

*Channelized left turn lanes and exit legs separate points of conflict and define vehicle paths, thereby greatly simplifying the left turn movement.*

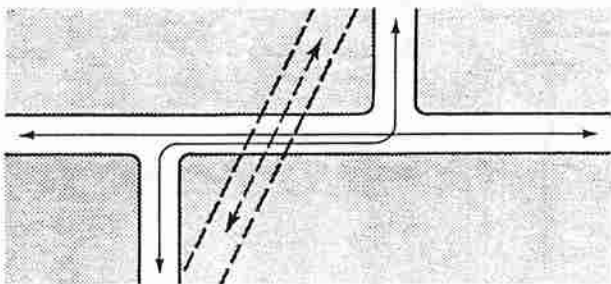

*Reconstruction of offset intersections eliminates the complex and difficult through movement "jog."*



**FUNCTIONAL OBJECTIVE OF CHANNELIZATION—**  
 Limitation of Conflict Frequency .

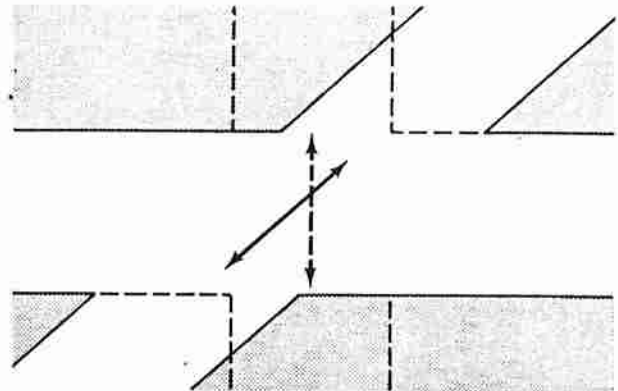

*Maintenance of 90° angles of intersection minimizes the time of exposure to cross traffic, thereby reducing the probability of actual crossing conflicts.*

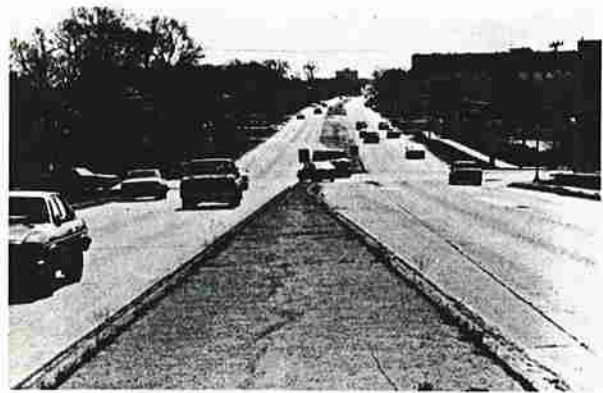
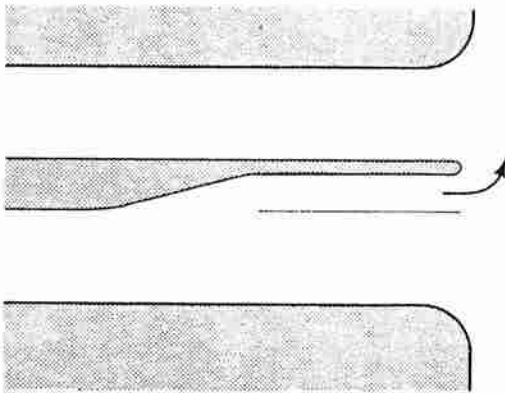

*The use of exclusive left turn lanes removes left turn queues from through lanes, thereby reducing the number of rear-end conflicts involving left turning vehicles.*

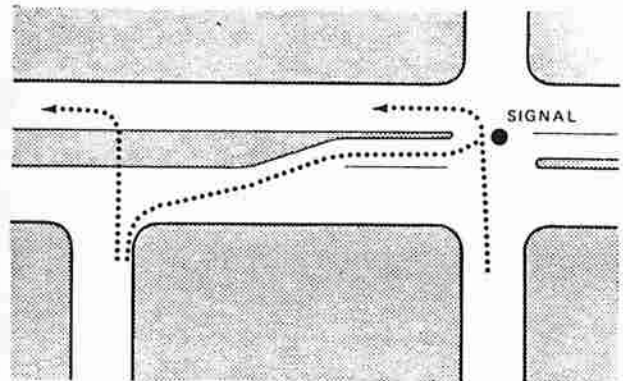

*Prohibition of left turns at stop-controlled intersections diverts movements to safer, signal-controlled intersections.*

*FUNCTIONAL OBJECTIVE OF CHANNELIZATION—  
Limitation of Conflict Severity*

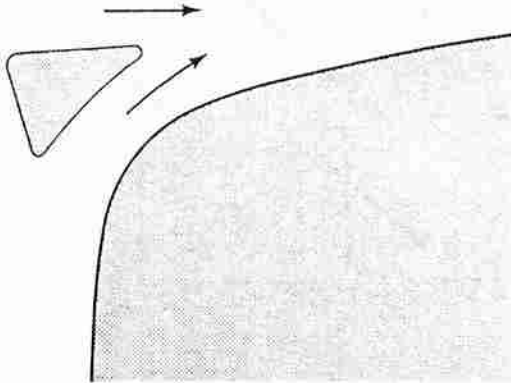

*Safe merging of traffic streams is accomplished by small angles of merge and acceleration tapers, both of which reduce conflict severity.*

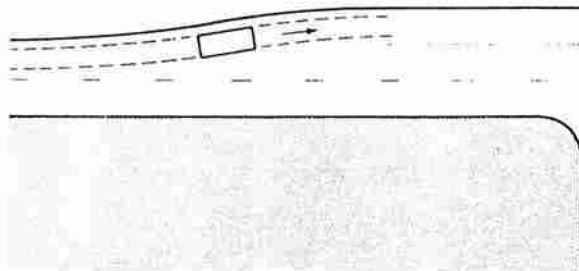

*Long transition tapers and turn lanes promote comfortable deceleration, enabling safer speed reductions. Note the potential combined effectiveness of appropriate striping and physical channelization.*

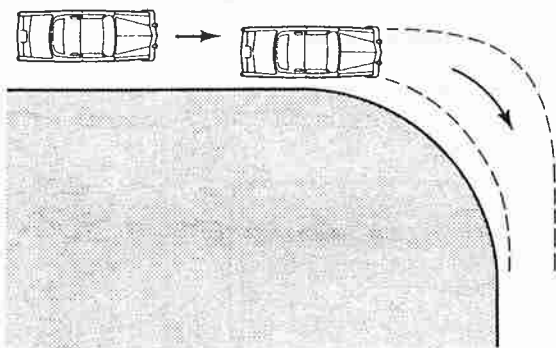

*Large right turn radii enables higher-speed turn turns, producing smaller speed differentials with following vehicles and thus less severe rear-end conflicts.*

**PRINCIPLES OF CHANNELIZATION**

The principles of channelization, detailed on the following pages, have evolved from an understanding of the operational nature of intersections, and from the functional objectives of intersection design. There are nine principles described:

1. Undesirable or wrong-way movements should be discouraged or prohibited through channelization.
2. Desirable paths for vehicles should be clearly defined by all elements of the intersection.
3. Desirable and safe vehicle speeds should be encouraged by the design of the intersection.
4. The design of the intersection should wherever possible separate points of conflict.
5. Traffic streams should cross at near-right angles and merge at flat angles.
6. The design of the intersection should facilitate the movement of high priority traffic flows.
7. The design of the intersection should facilitate its scheme of traffic control.
8. The intersection should accommodate decelerating, slow, or stopped vehicles outside higher speed through traffic lanes.
9. Safe refuge from motor vehicles for pedestrians, hand-capped, and others should be provided where appropriate.

Each of the nine principles is further detailed on the following pages.

The tools available to designers and traffic engineers for achieving channelization objectives are summarized in Figure 3-1. There are seven basic design and operational elements:

1. Traffic lanes (designation and arrangement).
2. Traffic islands (all sizes and types).
3. Median dividers.
4. Corner radii.
5. Approach geometry (including horizontal and vertical geometry).
6. Pavement tapers and transitions.
7. Traffic control devices (signs, signals, etc.).

The first six elements describe the range of physical features that comprises the intersection. The last element, traffic control devices, also belongs in this summary. Traffic control devices fulfill certain of the basic channelization functions. Furthermore, they are an integral part of any intersection.

Figure 3-1 shows which of the basic design elements are applicable in addressing the nine principles of channelization. Chapter Four of the design guide presents guidelines for the appropriate use and design of these elements.

DESIGN ELEMENTS	1) Prohibition of Movements	2) Definition of Vehicle Paths	3) Promotion of Safe Speeds	4) Separation of Conflict	5) Angles of Cross & Merge	6) Facilitation of High Priority Movements	7) Facilitation of Traffic Control	8) Accommodation of Slow/Decelerating Vehicles	9) Safe Refuge For Pedestrians
Traffic Lanes						•	•	•	
Traffic Islands	•	•		•	•		•		•
Median Dividers	•	•		•	•		•		•
Corner Radius	•	•	•			•			•
Approach Geometry	•	•	•	•	•	•			
Pavement Tapers/Transitions		•	•		•			•	
Traffic Control Devices	•			•		•	•		•

Figure 3-1. Principles of channelization.

## PRINCIPLES OF CHANNELIZATION

### 1) Undesirable or Wrong Way Movements Should Be Discouraged or Prohibited

Channelization -- traffic islands, raised medians and corner radii--should be used to restrict or prevent undesirable or wrong way movements. Where such movements can not be completely blocked, the channelization scheme should discourage their completion.

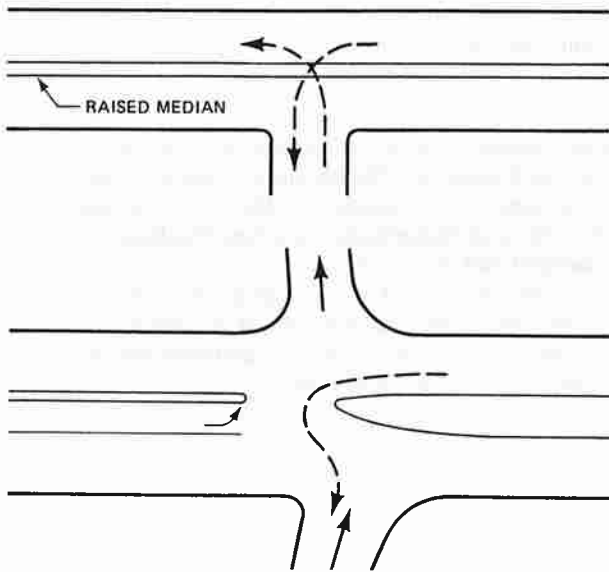

*Raised medians block left turns to and from minor streets or driveways. Such treatment may be appropriate at locations where left turns are dangerous or cause congestion.*

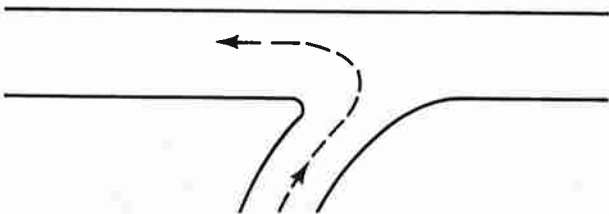

*Alinement of the approach and design of corner radii can encourage right turn only movements and discourage undesirable left turns.*

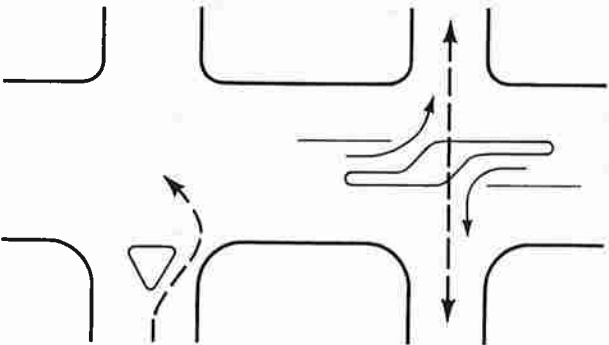

*Raised traffic islands can block through movements or undesirable turning movements without hindering other intersection movements.*

It is occasionally necessary to prevent certain traffic movements in order to promote safe or efficient traffic flow. Carefully designed channelization can achieve this goal without inhibiting other necessary or desirable movements.

Prevention of wrong way movements is particularly important on certain highways:

- Freeway Ramps
- One-way Streets
- Expressways and Other Divided Highways

In other cases, it may be necessary to prevent certain movements which tend to inhibit traffic flow.

- Left turn into driveways near intersections
- Commercial driveway access movements along divided arterials
- Multi-leg intersections

Also, channelization may be required to maintain the intended functional character of a street. Through traffic can be discouraged or prevented from using a local or residential street through judicious use of channelization.

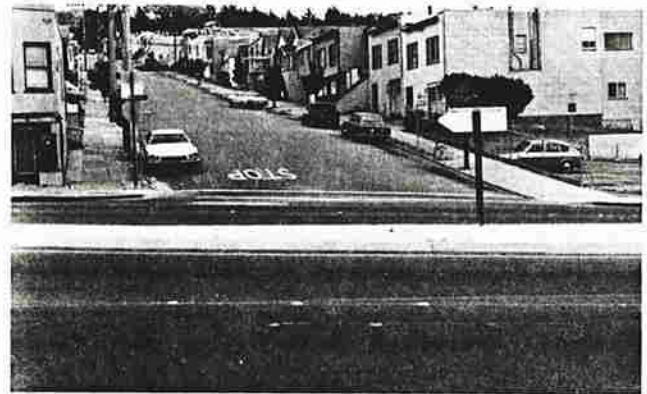

*Physical islands or raised medians block undesirable movements.*

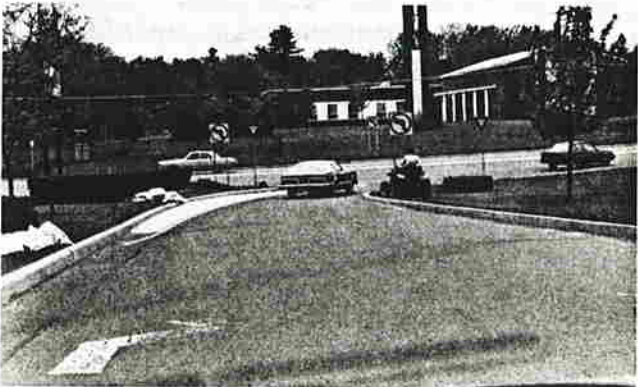

*Driveway design encourages the right turn only movements*



*Small (less than 5-foot) corner radii serve to discourage undesirable right turns.*

## PRINCIPLES OF CHANNELIZATION

### 2) Desirable Vehicular Paths Should be Clearly Defined

The design of an intersection, including its approach alignment, traffic islands, pavement markings and geometry, should clearly define proper or desirable paths for vehicles. Exclusive turning lanes should be clearly delineated to encourage their use by turning drivers and discourage their use by drivers intending to proceed through the intersection. Traffic islands should not cause confusion about the proper direction of travel around them.

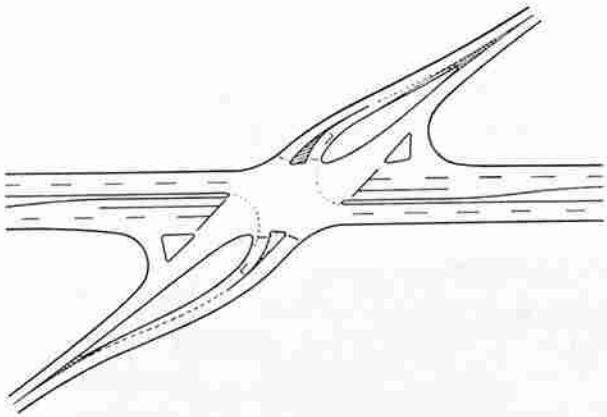

*Approach alignment, physical channelization and pavement markings work in concert to clearly define proper vehicle paths at this intersection. Left turn lanes are designed to minimize the chances of through vehicles wandering into them.*

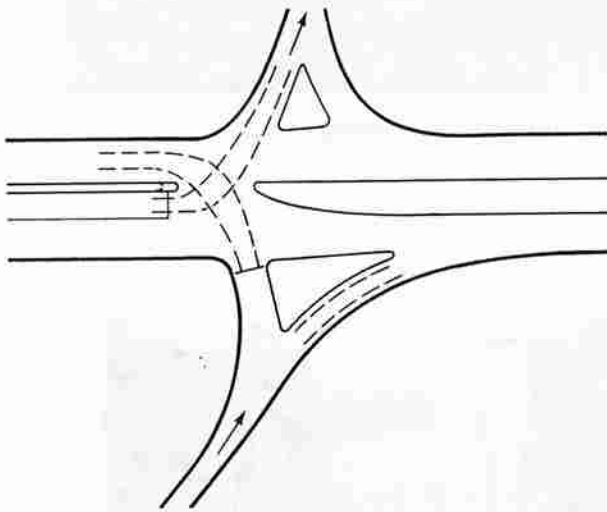

*Locations of islands and their design help to define appropriate paths of vehicles at freeway ramp terminal intersections. Clear path definition is particularly critical here because of potential for wrong-way movements and the need to accommodate high traffic volumes.*

Clear definition of vehicular paths can contribute greatly both to safe operation and greater intersection capacity. Good path definition "sorts out" various movements, and minimizes last second lane changes or inadvertent trapping of drivers in undesirable locations.

Clear path definition is especially appropriate at intersections with unusual geometry or unique traffic patterns. Examples include:

- Multileg intersections
- Skewed intersections
- Intersections at which a major route makes a turn
- Intersections with heavy turning volumes

Application of this principle should not be misconstrued by designers. It is not necessary, and in fact is often counter-productive, to channelize every movement with the use of many islands. Good judgment in defining vehicle paths should rely on driver expectations. Left turning drivers anticipate moving into the left lane to position themselves for the turn. Through drivers (or drivers following a primary, marked route) expect to remain on the highway. They do not anticipate having to make abrupt turns from the through lanes. Drivers generally recognize the general order of priority dictated by the types of movements (left turns, right turns, through movements) and traffic control. Channelization to define paths for these movements should reinforce these driver expectations.



*Turning movements and through lanes are clearly delineated with the use of tapers, pavement markings, and arrangement of lanes.*



*Left turn lanes should be clearly delineated from through lanes.*



*Channelization should clearly separate opposing traffic flows.*

## PRINCIPLES OF CHANNELIZATION

### 3) Desirable or Safe Vehicle Speeds Should be Encouraged

Channelization should promote desirable vehicle speeds wherever possible. In some instances this means providing open alinement to facilitate high-speed, heavy volume traffic movements. In other cases, channelization may be used to limit vehicle speeds in order to mitigate serious high-speed conflicts.

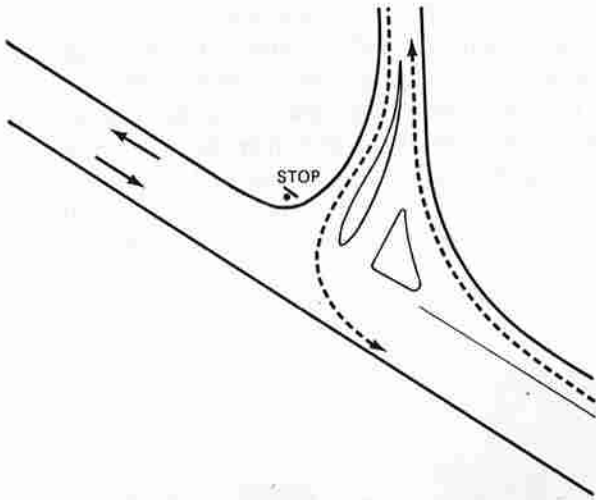

*Alinement and channelization promote deceleration and low speed approach to the stop sign. This facilitates safe left turns onto the major, unstopped highway. The right turn movement from the major highway is provided with high-speed channelization. This movement has a high priority and can be safely completed at high speed.*

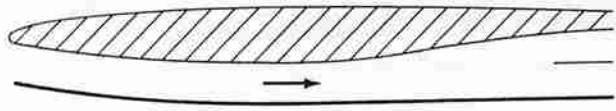

*The design of approach and turning bay tapers should promote safe comfortable deceleration and be consistent with driver expectancy. Long, smooth tapers on approaches are appropriate. Bay tapers should be short enough to clearly delineate the turning lane, and to avoid inadvertent trapping of through drivers.*

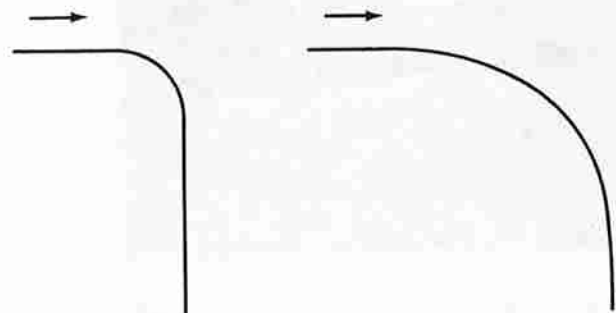

*Small turning radii, which promote low speed right turns, are appropriate where such turns regularly conflict with pedestrians. At other locations, capacity considerations may dictate the use of larger radii, which enable higher speed, higher volume turns.*



Promotion of safe speeds is critical to optimizing intersection safety. This means maintenance of speeds appropriate for the type and location of the intersection, as well as for the type of traffic control.

In certain cases, promotion of high speeds is desirable. These may include:

- Turning roadways from through legs of intersections on relatively high speed highways
- Through legs of relatively high-speed highways

In other cases, channelization should encourage or promote low speeds. For example:

- Intersections near schools, parks or other land uses that generate pedestrian traffic
- Approach to stop-controlled intersections of relatively high-speed highways

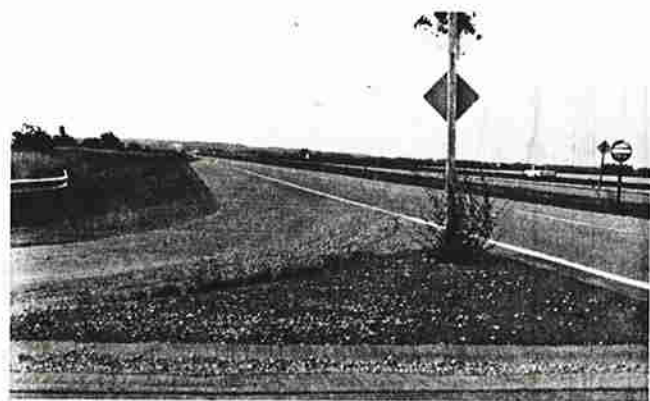
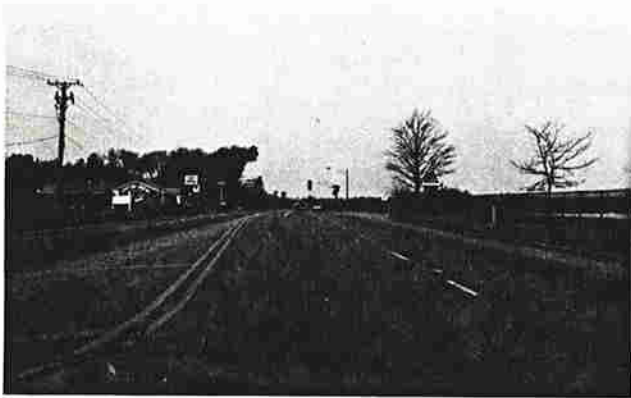

*Long, smooth tapers are appropriate for deceleration lanes on high-speed highways. Tapers should both delineate intended lane use and promote safe deceleration.*



*In urban areas, with pedestrians, parking and transit buses, low speeds should be encouraged for turning vehicles at intersections.*



*T-type crossings for stopped approaches promote safe deceleration and braking. They also optimize the driver's view of approaching traffic from both directions of the major roadway.*

## PRINCIPLES OF CHANNELIZATION

### 4) Points of Conflict Should be Separated Where Possible

Separation of points of conflict eases the driving task. Channelization techniques such as development of turning lanes, design of islands and control of access points all serve to separate points of conflict. This enables the driver to perceive and react to conflicts in an orderly manner.

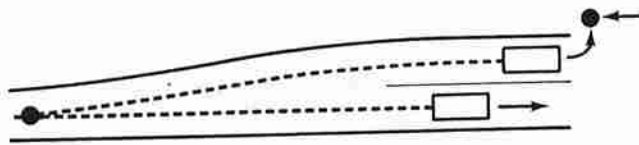

*Exclusive turning lanes separate rear-end conflicts associated with decelerating, diverging vehicles from the turning and crossing conflict points within the intersection.*

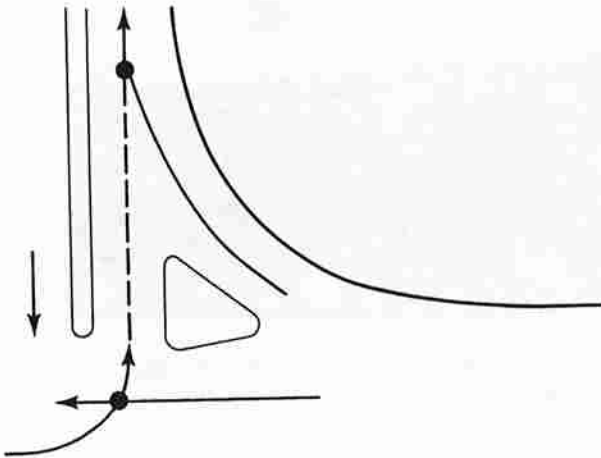

*Highly channelized right turns separate merge-related, right turn conflicts from other turning and crossing conflicts within the intersection. Median dividers separate head-on conflicts.*

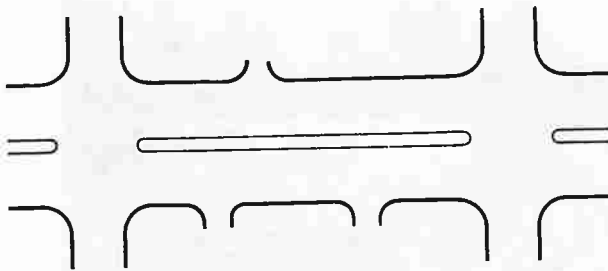

*Maintenance of adequate intersection and driveway spacing combined with access control separates points of conflict along a corridor.*

Conflict separation can improve both capacity and safety. Development of turning lanes, and access control through median channelization, promote corridor capacity by separating local turning conflicts from through traffic. Separation of opposing traffic lanes at intersections eases left turn and through movements by providing an additional margin of error for vehicles that wander outside their optimal path.

Separation of conflict points should focus on the element of **time** and its relationship to the driving task, which includes perception, reaction, navigation and execution of the necessary maneuver. Thus, appropriate design for conflict separation must be sensitive to prevailing speeds. Many safety problems at older, highly channelized rural intersections can be traced to insufficient distance (and time) between points of conflict.



*Left turn lanes reduce rear-end conflicts.*

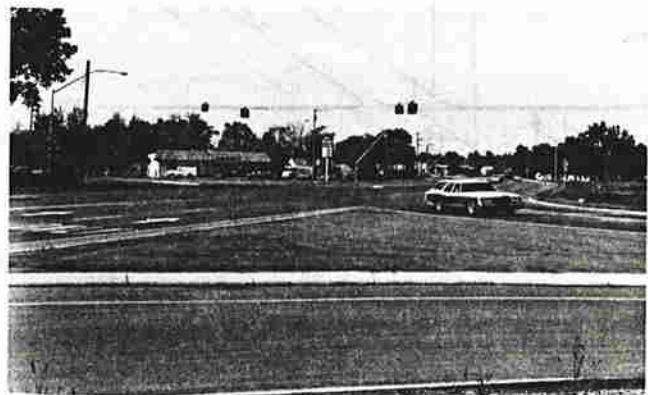

*Right turn lanes remove rear-end conflicts in advance of crossing conflicts at unsignalized intersections.*



*Separation between frontage roads and through arterials eases the driver's task of handling multiple conflicts.*

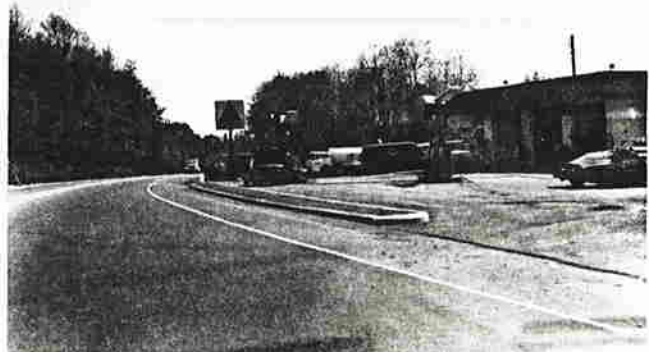

*Closing up a wide, open driveway restricts movements to designated locations. Exit and entry conflicts are thus more readily separated.*

## PRINCIPLES OF CHANNELIZATION

### 5) Traffic Streams Should Cross at Right Angles and Merge at Flat Angles

Crossing and merging of traffic streams should be accomplished to minimize both the probability of actual conflict or collision, and the severity of conflict. Channelization and alignment design should produce crossing vehicle streams at as close to right angles ( $90^\circ$ ) as is practical. Where vehicle streams merge, the alignment of the merging roadways should be accomplished at flat angles.

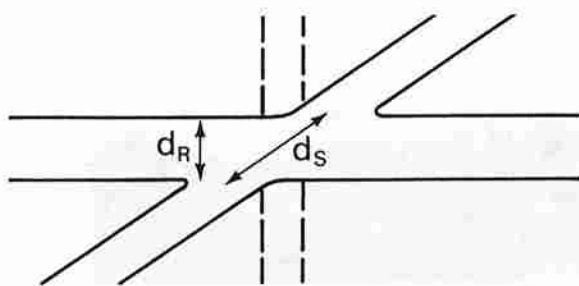

Right angle crossings minimize the distance and time of exposure to crossing conflicts within the intersection. In the schematic example at left,  $d_R$ , the crossing distance for a right angle intersection, is considerably smaller than  $d_S$ , the crossing distance associated with a skew angle of about  $45^\circ$ .

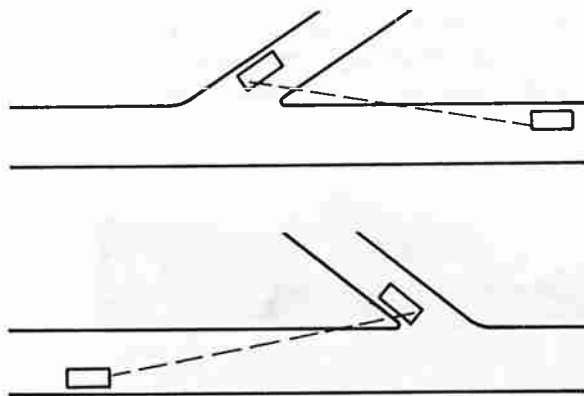

Skewed crossings also produce awkward and often obstructed sight angles for drivers approaching on the angled highway. Angled crossings such as the lower example are particularly undesirable, as the driver's sight line is obstructed by the vehicle interior.

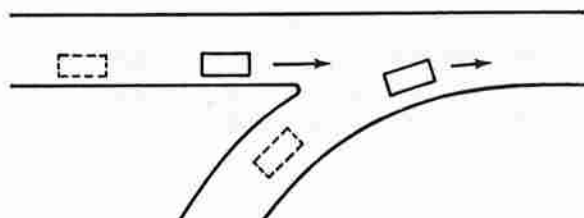

Roadways that merge at flat angles facilitate the actual merging maneuver. In addition, flat angle merges lessen impact energy, thereby resulting in less severe accidents and conflicts.

Design for crossing and merging traffic streams should reflect approach geometry, traffic control in effect, and prevailing speeds.

Right turn movements intended to operate as free movements or under yield control should be designed with flat angle merging areas. Where it is intended that vehicles stop before completing the turn, the channelization should promote a stop at right angles to the crossing facility.

The importance of avoiding severe skew angles varies with the type of intersection. Low-speed, signalized intersections can be operated adequately without altering the angle, through long amber and/or all-red signal indications. At high-speed, rural intersections under stop control, however, sight angle and exposure problems caused by skew angles may be serious.

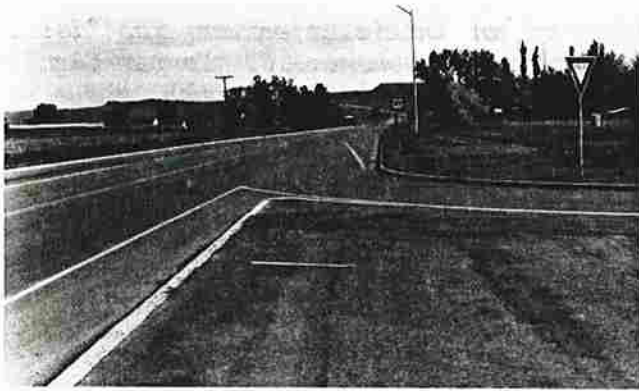

*Turning lanes that operate freely or from yield control should be designed to promote safe merging.*



*Skewed intersections create large, open intersection areas, and increase vehicles' exposure to crossing conflicts.*

*Right angle crossings minimize the time and distance of exposure to conflicts.*

## PRINCIPLES OF CHANNELIZATION

### 6) High Priority Traffic Movements Should be Facilitated

The operating characteristics and appearance of intersections should reflect and facilitate the intended high priority traffic movements. Selection of high priority movements can be based on relative traffic volumes, functional classification of the intersecting highways, or route designations.

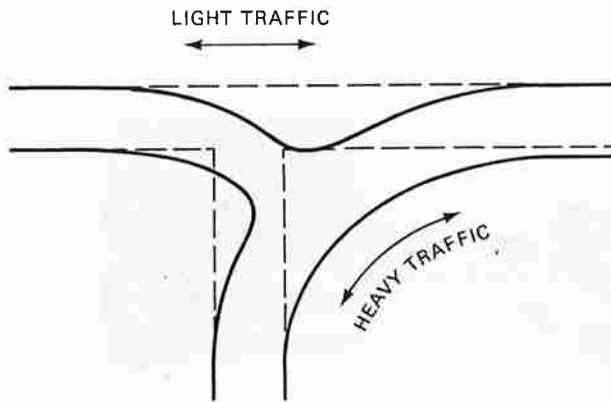

*Realignment of an intersection can facilitate a predominant movement. Former turning movements are converted to through movements, with other, lighter volume movements subordinated.*

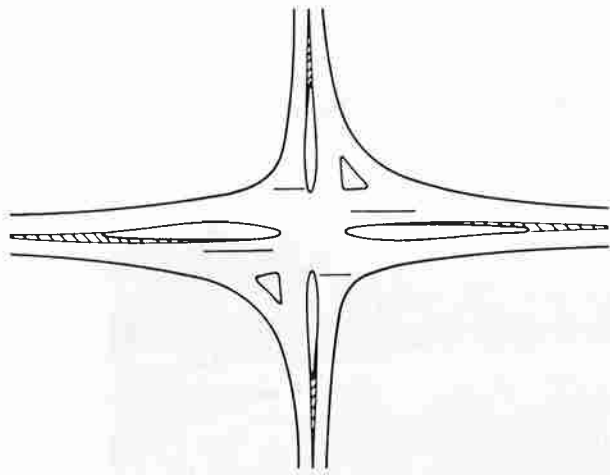

*Facilitation of through traffic on the major route is accomplished by fully channelizing both major route approaches. Separate left turn lanes and highly channelized right turns minimize and separate conflicts involving through vehicles. The appearance of the intersection from all approaches is consistent with its prioritized operation.*

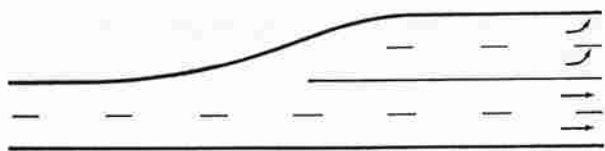

*Arrangement of lanes at approaches to intersections often is based on proportions of turning and through traffic. Double left turn lanes facilitate very high left turn volume demands.*

Accommodation of high priority movements involves consideration of highway capacity and operations, and driver expectations. The form and appearance of basic approach geometry should clearly reinforce the intended priority movements. This is especially important at intersections with unusual characteristics, such as:

- Intersections with route turns
- Multi-leg intersections
- Heavy volume turns

Geometry and channelization can also be effective in reinforcing the traffic control. At unsignalized rural intersections, design of stop-controlled approaches should produce an appearance distinctly different from that of through or unstopped approaches.



*The major, through movement is the most direct through the intersection.*



*Despite the curved alignment through the intersection, the through movements proceed directly.*



*Major turning movements should be delineated with channelization, pavement markings and signing.*



*In central business districts, pedestrians receive high priority. Pedestrian movements are facilitated by wide, well-marked crosswalks, ramps for handicapped, and adequate crossing time.*

## PRINCIPLES OF CHANNELIZATION

### 7) Desired Traffic Control Scheme Should be Facilitated

The channelization employed should facilitate and enhance the traffic control scheme selected for intersection operation. Location and design of exclusive lanes should be consistent with signalization or stop control requirements. Location of traffic islands, medians and curb returns should reflect consideration of the need to place signals and signs in locations visible to drivers.

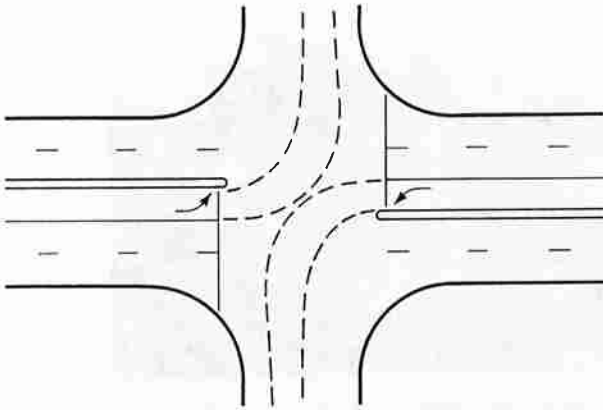

*The use of exclusive left turn lanes at signalized intersections greatly improves operations by providing flexibility in phasing schemes. This enables easy adjustments in operation to reflect variability in traffic patterns throughout the day; or changes in area travel over time. Designs that safely accommodate simultaneous opposing left turns are particularly flexible.*

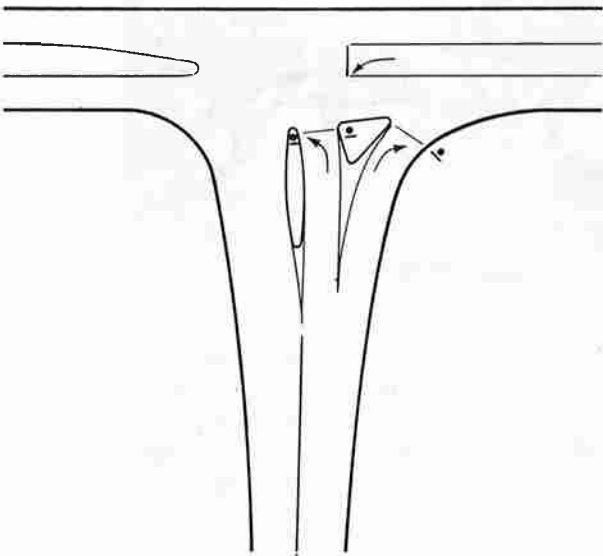

*Traffic islands, in addition to serving other functions, are appropriate locations for stop and yield signs. Use of islands in this manner results in the sign being placed at the stop line and within the driver's cone of vision. Also note the use of separate turning lanes at this stop-controlled intersection. Provision for a right turn lane eliminates unnecessary delays to right turning vehicles from drivers waiting to make the more difficult left turn.*



Traffic control and intersection geometry are by necessity closely related. A good channelization plan reinforces driver perception of the traffic control plan, as well as optimizes intersection operation under that plan.

Facilitation of traffic control involves appropriate arrangement of approach lanes and corner radii and location and design of median dividers and traffic islands. These considerations are important in maximizing intersection capacity under the intended traffic control scheme. They also directly affect the actual location of important signs, traffic signals, stop bars and other traffic control markings.

For example, at stop-controlled approaches to intersection's the intersection design should encourage the necessary stop, and should provide clear sight lines to both directions of cross traffic. At signalized intersections, island placement and lane arrangements should be coordinated to provide clear signal indications from all approach lanes.



*Left turn lanes facilitate signal phasing.*

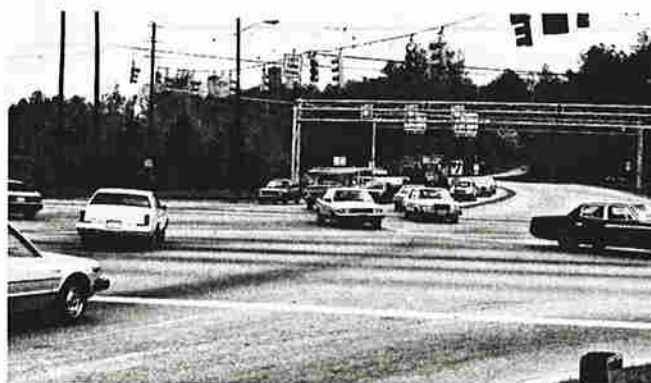

*Lane arrangements and proper intersection design can enable simultaneous left turn opposing movements.*



*Raised islands are useful for placement of traffic control devices in locations within the driver's normal sight lines.*



*Stop controlled intersections on high-speed highways must be designed with adequate sight distance.*

## PRINCIPLES OF CHANNELIZATION

### 8) Decelerating, Stopped or Slow Vehicles Should be Removed From High-Speed, Through Traffic Streams

Intersection design should wherever possible produce separation between traffic streams with large speed differentials. Vehicles that must decelerate or stop because of traffic control or to complete a turn should be separated from through traffic proceeding at higher speeds. This practice facilitates safe completion of all movements by reducing rear-end conflicts.

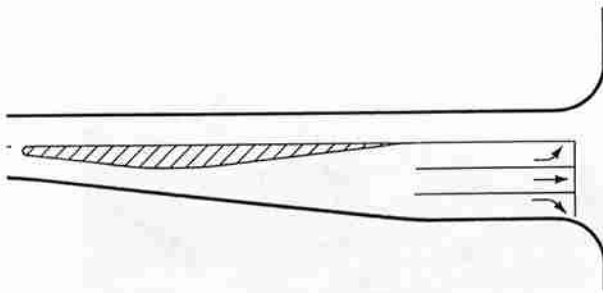

*Separate left- and right-turn lanes on high-speed rural highways remove decelerating vehicles from through traffic. The potential severity of high-speed rear-end conflicts makes the use of separate turn lanes desirable regardless of turning traffic volume.*

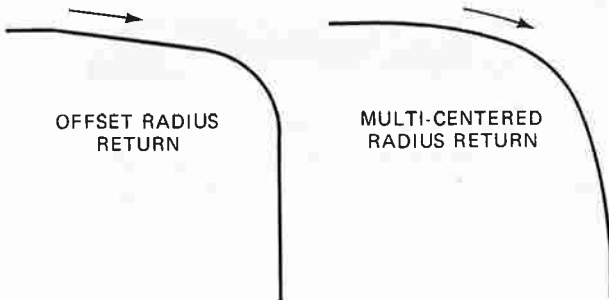

*Large corner radii, or offset or multi-centered radii, facilitate right turns off high-speed highways.*

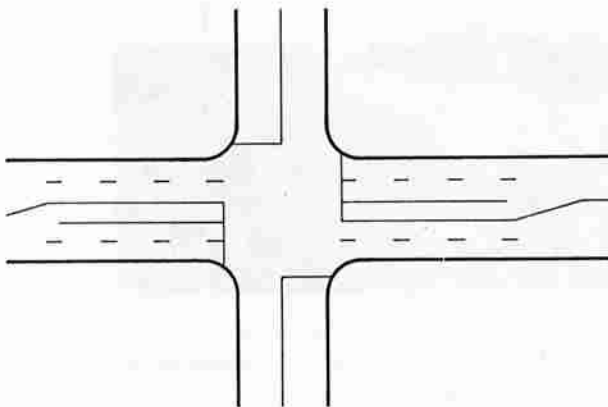

*On low-speed arterials or urban streets, left turn lanes remove queued vehicles from through traffic. This enables left turning traffic to either await their signal indication or select a gap in opposing traffic without impacting through traffic flow.*

Differentials in speeds of vehicles within the same traffic stream are among the primary causes of traffic accidents. Speed differentials are particularly significant at intersections because of the frequency of their occurrence. All turning vehicles must decelerate to a safe and comfortable turning speed, which is typically 10 - 15 miles per hour. Left-turning vehicles often must decelerate to a stop for either response to a traffic control device, or to await a gap across opposing traffic.

Separation of these slow and/or stopped vehicles from through lanes promotes intersection safety by reducing or eliminating rear-end conflicts. Intersection capacity is also improved. Through vehicles can proceed without being impeded by turning vehicles in front of them.



*Left turn vehicles awaiting gaps can safely queue within left turn storage lanes.*



*Right turn deceleration lanes off high-speed highways promote safe turning speeds.*



*Long approach tapers and lane lengths are necessary to provide for safe deceleration for turning vehicles.*



*Continuous two-way left turn lanes promote safe access to multiple driveways outside higher speed through lanes.*

## PRINCIPLES OF CHANNELIZATION

### 9) Provide Safe Refuge For Pedestrians and Other Non-motor Vehicle Users

Channelization can shield or protect pedestrians, bicycles and handicapped within the intersection area. Proper use of channelization will minimize exposure of these vulnerable users to vehicle conflicts, without hindering vehicular movements.

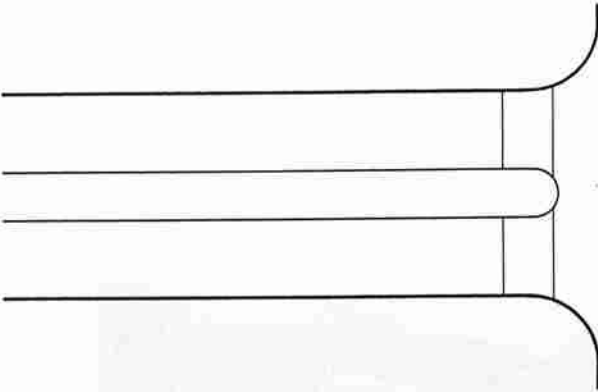

*Raised median channelization of sufficient width provides midway refuge for pedestrians crossing wide arterial streets. This reduces total time of exposure to conflict, and also greatly eases the crossing task. With median refuge, pedestrians can concentrate on one direction of traffic at a time. This is particularly important to the elderly and handicapped, whose travel times crossing the intersection are much greater than the general population.*

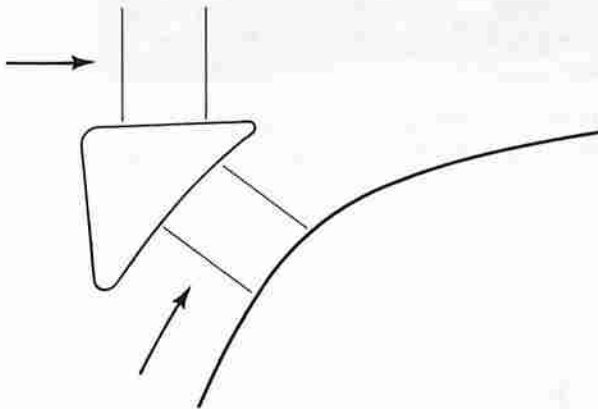

*Unchannelized right turns with large turning radii greatly increase open pavement area, and pedestrian exposure to conflicts. Raised traffic islands serve as locations of pedestrian refuge, reducing maximum time of exposure to conflicting vehicular flows for easier crossing.*

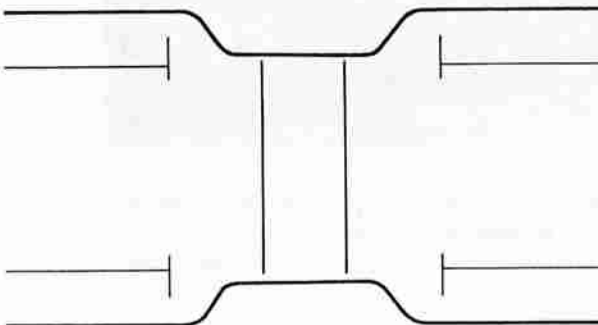

*Midblock sidewalk "peninsulas" facilitate pedestrian crossings by reducing crossing times. This use of channelization also partially shields parallel parked vehicles. (Such special midblock treatments are appropriate only on low-speed streets. Signing to alert drivers of midblock pedestrians is important.)*

Provision for pedestrians, bicycles and the handicapped is highly important because of the vulnerability of these users to serious conflicts with motor vehicles.

In many cases, traffic islands intended to serve as channelization devices for motor traffic are adaptable to pedestrian refuge. Maximum utility of these islands is gained if their design is sensitive to pedestrian needs.

In other instances, channelization may be introduced specifically for refuge of pedestrians. In these cases, it is essential that such treatments not adversely affect vehicular traffic flow.



*Large, raised traffic islands provide pedestrian refuge.*



*Raised medians of sufficient width are also used by pedestrians crossing wide arterials.*



*Median design and crosswalk placement can be coordinated to provide refuge to pedestrians and the handicapped. Note the break in the median islands at the crosswalk. This design specifically accommodates wheelchairs.*

## GUIDELINES FOR DESIGN OF CHANNELIZED INTERSECTIONS

One or more of the principles of channelization are applicable at every intersection. Good, cost-effective design focuses on the important principles and objectives of a particular location. Clearly, optimizing level of service and safety means different things for different intersections. The functional classification, location, traffic characteristics and environmental conditions tend to dictate what is acceptable or possible in terms of safety and delay. This, in turn, influences which of the principles apply, their relative priority, and how the design elements should be combined to produce the desired operation.

Consider, for example, Figure 4-1, which describes operational and safety considerations for intersections in different locations. The design focus is obviously different for an intersection on a primary, two-lane rural highway from that for an intersection in a central business district.

In this chapter of the design guide, guidelines for the design of intersection elements are presented. These guidelines are based on an assessment of current standards and practices na-

tionwide, and a review of the technical literature on intersection safety and operations. Their development and presentation reflects the wide variation in operating conditions and priorities indicated in the previous discussions.

Designers should apply the guidelines presented here within the context of their own experience, local practices, and costs. Intersection design is sufficiently complex to defy warrants or guidelines that address all possible conditions. Instead, these guidelines are intended to assist designers and traffic engineers in their decision-making, and to provide technical background for assessing the effects of their designs.

A review of the guidelines will show that they are sensitive to the full range of operating conditions as described by the functional classification of intersecting highways, the location and environmental conditions, traffic volumes and mix, and typical or prevailing vehicle speeds. In general, design values are described in functional terms, i.e., the dimensions are directly related to a desired or intended operating characteristic.

	RURAL INTERSECTIONS	SUBURBAN INTERSECTIONS	URBAN INTERSECTIONS
OPERATIONAL CONCERNS	<ul style="list-style-type: none"> <li>• Maintenance of High Speeds for Through Movements</li> <li>• Navigation for Unfamiliar Drivers</li> <li>• Provision for Comfortable Turning Movements</li> </ul>	<ul style="list-style-type: none"> <li>• Maintenance of Flexibility to Accommodate Traffic Growth</li> <li>• Control of Access Along Major Routes</li> <li>• Capacity of Major Signalized Intersections</li> </ul>	<ul style="list-style-type: none"> <li>• Intersection Capacity</li> <li>• Accommodation of Parking, Deliveries</li> <li>• Maintenance of Signal Progression Schemes and Network Considerations</li> </ul>
SAFETY CONCERNS	<ul style="list-style-type: none"> <li>• Mitigating Rear-end Conflicts Caused By Turning Vehicles</li> <li>• Providing Adequate Geometry and Sight Distance For Safe Gap Acceptance</li> <li>• Avoiding 'Surprise' Situations (e.g., hidden intersections, unusual channelization)</li> </ul>	<ul style="list-style-type: none"> <li>• Angle and Rear-end Conflicts at Congested Intersections</li> <li>• Localized Pedestrian-Related Problems (Schools, Shopping)</li> <li>• Driveway Access Conflicts</li> </ul>	<ul style="list-style-type: none"> <li>• Pedestrian Conflicts</li> <li>• Angle and Rear-end Conflicts at Congested Intersections</li> </ul>

Figure 4-1. Operational and safety concerns at intersections.

**NUMBER OF LEGS/TYPES OF INTERSECTIONS**

Intersections can be characterized as one of four basic types: 3-leg (including both T- and Y-types), 4-leg, multi-leg and special or unusual types (e.g., rotary intersections). While the geometry and other conditions may vary, in general an intersection's complexity increases with the number of approach legs it includes.

Figure 4-2 demonstrates the complexity of intersections in terms of number and types of conflicts that occur at 3- and 4-leg intersections. Safety research confirms the effect of traffic volumes and potential for conflicts (as defined by number of approach legs). One major study, summarized in Figure 4-3, revealed comparable accident rates for 3-leg and cross or 4-leg

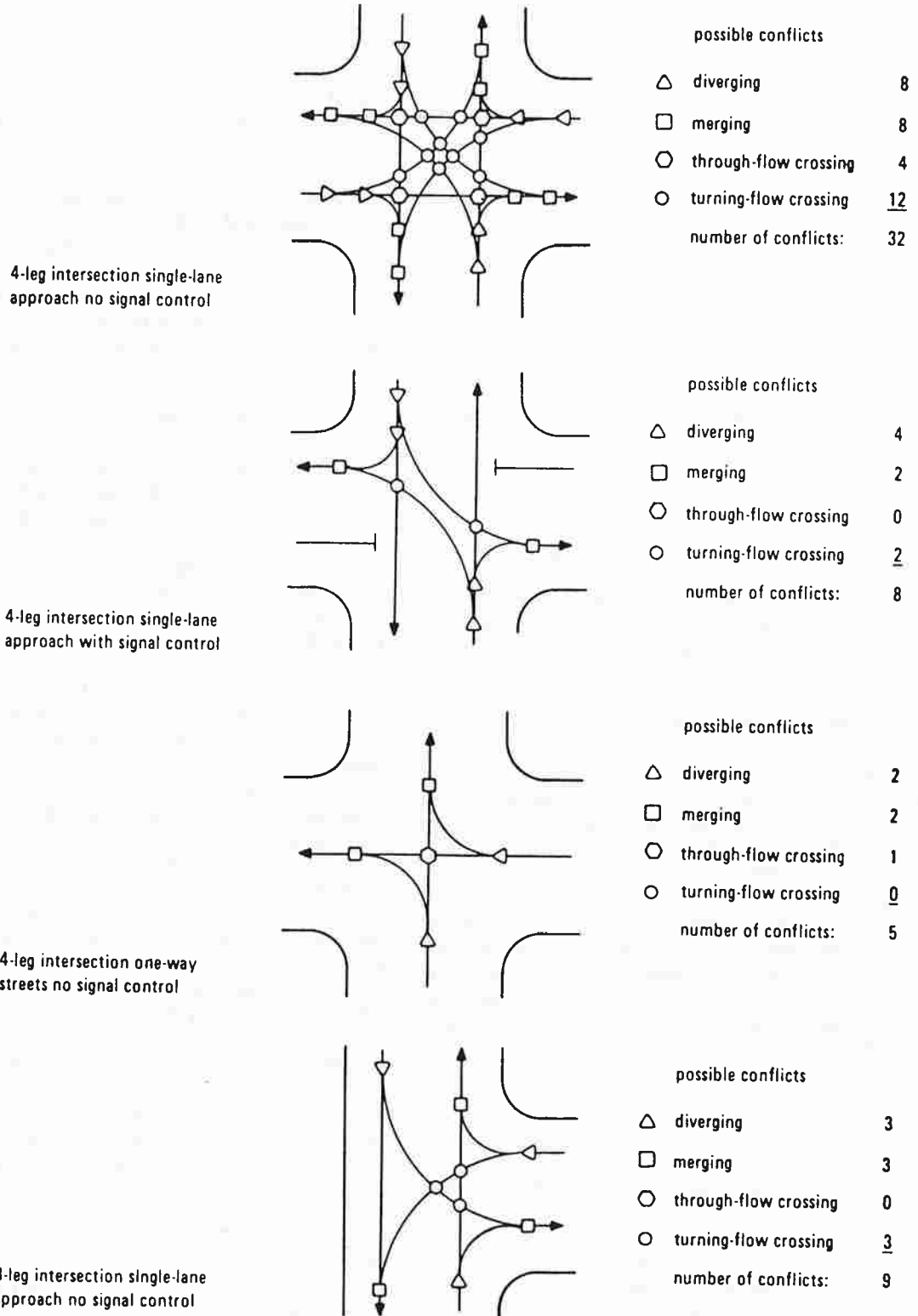

Figure 4-2. Intersection conflicts. (Source: Ref. 4-1)

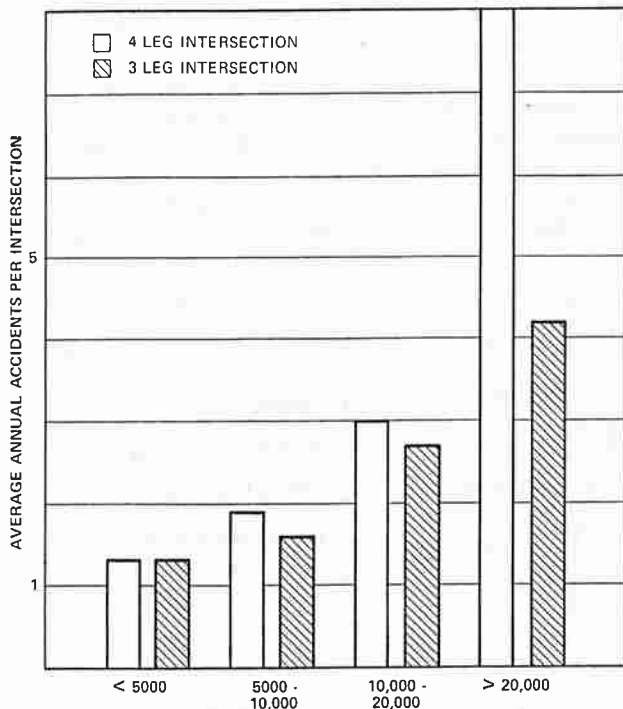

Figure 4-3. Accident rates at 3- and 4-leg intersections. (Source: Ref. 4-6)

intersections for low to moderate traffic volumes. As entering traffic increased to over 20,000 ADT, however, observed accident rate for 4-leg intersections dramatically increased. Although no studies specifically address 5-leg intersections, it is clear that their general characteristics would be expected to produce relatively high accident rates.

#### Design Guidelines For New Construction

Multi-leg (i.e., 5 or more legs) intersections should be avoided in design of new highways. This should be accomplished in the route or corridor planning stages. Realignment of one or more of the approaches to create two simple intersections is a typical solution. Other solutions may include grade separations or route closures.

Rotary intersections are generally not considered viable designs for new highways. Their use is applicable only for low-volume residential streets or recreational areas. Rotaries create frequent weaving conflicts under all but very low volume conditions. The rotary is difficult to sign, is confusing to unfamiliar drivers, and produces high accident rates.

#### Reconstruction/Rehabilitation and Operation of Existing Intersections

At existing intersections, improvements to multi-leg configurations require evaluation on a case-by-case basis. Most such problems exist in urban areas, where right-of-way is severely restricted and major reconstruction alternatives limited usually, a combination of channelization improvements and traffic management/control measures is applicable.

Evaluation of channelization/traffic engineering measures should focus on accident patterns and capacity constraints. Figure 4-4 details the range of possible measures:

- Closure of one or more legs.
- Institution of one-way operation on one or more leg.
- Restrictions in permitted turning movements.
- Minor realignment.

Where existing multi-leg intersections must remain, consideration of their operation is important. The great number of conflict points merits signal control unless volumes are very low. A key in operating signal-controlled multi-leg intersections is provision for left turns. Removal of adjacent on-street parking and use of narrower lanes may enable provision for left-turn lanes on all approaches.

Where existing rotary intersections are operating, their accident history and traffic growth should be continually monitored. Weaving-related accidents such as rear-end and sideswipe types can be expected to increase significantly as traffic volumes grow. Design alternatives to rotaries include conversion to a conventional 4-leg intersection with traffic signal control, or construction of a grade-separated interchange.

#### ANGLE OF INTERSECTION

The angle of intersection of two highways can greatly influence the intersection's safety and operational characteristics. Both individual vehicle operations and the nature of vehicle/vehicle conflicts are affected by angle of intersection. Heavy "skew" intersection angles produce large open pavement areas within the intersection. Such intersections are not only more costly to build and maintain, but are undesirable operationally for the following reasons:

1. Vehicles crossing the intersection are exposed for a longer time to conflicts from crossing traffic. This may be a particularly critical problem at STOP-controlled approaches on high-speed highways.
2. The driver's sight angle to one of the crossing legs becomes more restricted. This increases the difficulty of perceiving safe crossing gaps.
3. Pedestrians, as well as vehicles, are subjected to longer times of exposure to conflicting vehicles.
4. Vehicular movements are more difficult because of the skew. Accommodation of large truck turns may necessitate additional pavement and channelization not otherwise called for. The greater open pavement heightens the opportunity for vehicles to wander out of their proper paths.

Although no previous research specifically addresses skewed intersections, the extent of the effect of intersection angle can be estimated in general terms. One study (4-2) of intersections in rural municipalities demonstrated the predominance of right-angle-type accidents at STOP-controlled intersections. Similarly, the same study revealed that intersections with poor sight distance experienced high percentages of right-angle accidents. Other studies (4-3) indicate improved accident experience results from measures designed to increase intersection sight distance. The angle of skew clearly is related to right-angle and other accidents associated with poor sight distance.



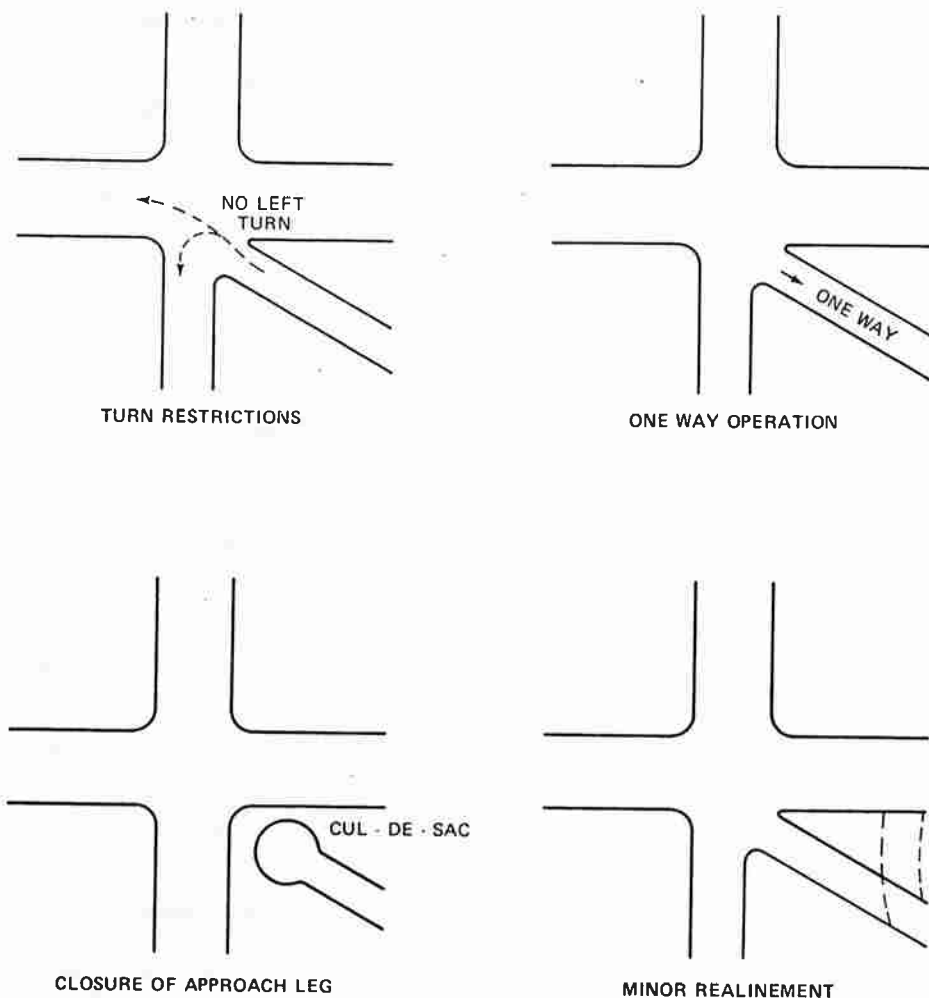

Figure 4-4. Alternatives to multileg intersections.

Current design standards explicitly reflect the importance of controlling the angle of intersection wherever possible. As is shown in Table 4-1, angles of 75 deg to 90 deg are generally considered desirable, with 60-deg angles considered acceptable.

**Design Guidelines For New Construction**

Angles of intersection should wherever possible be maintained at 75 deg to 90 deg. Where costly or severe constraints occur, angles as low as 60 deg are acceptable. New intersections should not include skewed angles less than 60 deg without special design and control features to mitigate the effects of the skew. These may include more positive traffic control (all stop, traffic signals) and/or geometric improvements such as greater corner sight distance.

**Reconstruction/Rehabilitation**

Where severe skew angles exist, the need to consider improvements should be assessed, with primary emphasis given to examination of accident rates and patterns. A high incidence of right-angle accidents, particularly involving vehicles approach-

ing from the acute angles, may be evidence of a problem attributable to the skew.

**Table 4-1. Statements from selected state design policies on angle of intersection.**

<i>Alaska, Illinois, Wisconsin</i>	
Angle of intersection should be desirably no more than 75 deg, and a minimum of 60 deg.	
<i>Colorado</i>	
Skews not more than 30 deg (60 deg) do not materially increase crossing distances or decrease visibility unreasonably, and are therefore considered satisfactory.	
<i>Minnesota</i>	
Realignment should be considered for intersections with angles in excess of 20 deg (70 deg).	
<i>Ohio</i>	
Skew angles of 70 deg to 90 deg are recommended, with 60 deg considered satisfactory and 50 deg appropriate only for "salvage" type projects.	
<i>Nebraska</i>	
Up to 30 deg (60 deg) skew is allowable at minor intersection.	
<i>Idaho</i>	
Minimum angles of 70 deg, with 75 deg desirable, are considered appropriate for ramp terminal intersections.	

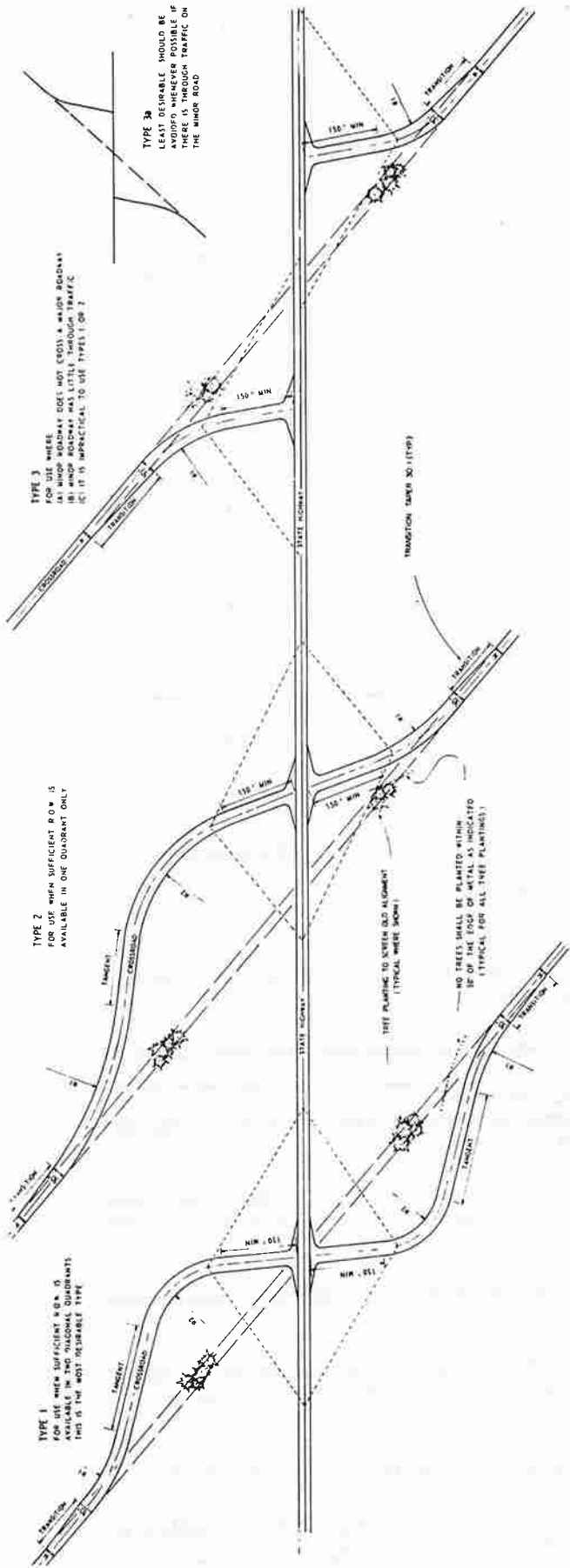

Figure 4-5. Alternatives to skewed intersections. (Source: Michigan Department of Transportation)

*Geometric Countermeasures*

Geometric countermeasures, although expensive, are generally the only way to directly treat skewed angle intersections. Reconstruction should reflect traffic patterns at the intersection as well as constraints such as available right-of-way. Figure 4-5, adapted from design standards used by Michigan Department of State Highways, summarizes potential treatments for reconstruction of skewed intersections. While Types 1 and 2 are desirable because they maintain the simple crossing, Type 3 may be applicable if the road to be rebuilt is minor and carries little through traffic. Note that Type 3A is generally not desirable, because it forces through-traffic on the minor road to turn left while on the major highway.

All the design possibilities shown in Figure 4-5 provide for adequate tangent approach distance on the rebuilt legs. Avoidance of curves at or near intersections is a design principle discussed later in this chapter. In particular, special attention is required to provide adequate sight distance to a STOP sign or traffic signal on a realigned approach.

*Traffic Control Countermeasures*

Crossing conflict problems created by skew angles may be best treated by upgrading the traffic control at the intersection. Installation of traffic signals may be less expensive than reconstruction. When operated in full or partial actuation, delay to the major highway can be minimal.

**Design Detailing**

In completing the design of an approach with a skew angle, care should be taken to minimize its effect. Stop bars and median island noses should be placed as close to the intersection as possible to reduce the large open area. Designs for left turning trucks can assume use of the full throat width (see Figure 4-6).

Special attention should be placed on providing clear corner sight distance, particularly at unsignalized intersections and/or intersections on high-speed highways.

**HORIZONTAL AND VERTICAL ALINEMENT**

Design of the horizontal and vertical alinement on the approaches to and through an intersection is critical. The alinement should promote driver awareness of the intersection, and should enable the driver to focus on the perception, navigation, and reaction tasks associated with intersections. The following specific operational needs should be incorporated into alinement design near intersections:

1. Alinement should provide decision or desirable stopping sight distance (rather than just minimum stopping sight distance) to the intersection, as well as adequate corner sight distance at the intersection.
2. Alinement should safely operate under frequent braking (such as for traffic control, navigation, and collision avoidance) typically associated with intersections.
3. Alinement should not be overly difficult to drive, so that driver attention can be placed on the intersection ahead.

The effect of approach alinement on accident rates was dramatically demonstrated by Kihlberg and Tharp (4-4). Comparisons of 0.3-mile highway sections of "pure" (tangent) alinement with those containing intersections, and with others containing intersections and curves and/or grades, are shown in Figure 4-7. Data for Ohio showed that the presence of curves greater than 4 deg, in conjunction with an intersection, created significantly higher accident rates on 2-lane rural highways.

A number of state design agencies explicitly recognize the importance of the alinement at and near the intersection. As Table 4-2 indicates, problems with sight distance, braking, and navigation are expected at intersections with concurrent steep grades and/or sharp curves.

**Design Guidelines for New Construction**

Designers should avoid locating intersections at or near alinement that is difficult to drive, or that significantly increases vehicle braking requirements. The following guidelines are suggested:

- Avoid approach grades greater than -6 percent on low speed (30 to 35 mph) highways; and approach grades greater than -3 percent on high speed (50 mph and greater) highways.

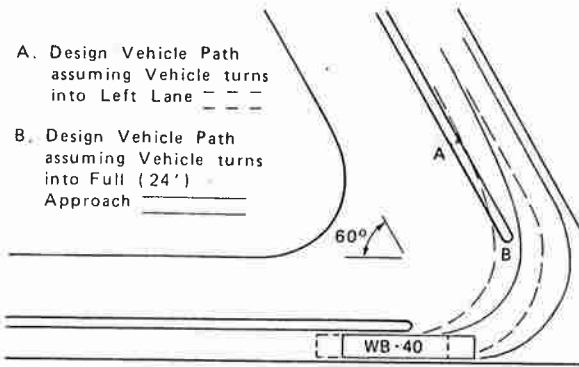

Figure 4-6. Effect of skew and intersection design on operations.

Table 4-2. Statements in state design standards regarding alignment design near intersections.

**Minnesota**

Intersections on horizontal curves should be avoided. The curvature adds an additional element of complexity to the highway information that must be processed by the driver, thereby increasing the hazard. It also complicates the geometric design elements of sight distance, channelization and superelevation.

**Mississippi**

Intersection of highways on sharp curves should be avoided wherever possible since the superelevation complicates the intersection design and the curvature may contribute to sight distance problems.

**Nebraska**

Intersections occurring on horizontal or crest vertical curves are undesirable with respect to operation as well as sight distance. When selecting an intersection location, avoid horizontal and vertical curvatures wherever possible. . . .

**Nevada**

All elements of the geometric design for alignment and grade should be in balance to permit drivers to detect approaching vehicles and readily make the maneuvers necessary to pass through the intersection with safety and with a minimum of interference between vehicles.

**Ohio**

The grade of the through road desirably should be 3 percent or less, with a maximum grade of 6 percent. When feasible, avoid steeper grades within the intersection area for ease in turning and because drivers tend to misjudge the stopping and starting abilities of their vehicles on grades steeper than 3 percent.

It is best to avoid intersection locations on a through road curve. . . .

**Wisconsin**

Steep grades within the intersection area and on the portion of approaches where vehicles are required to stop should be avoided.

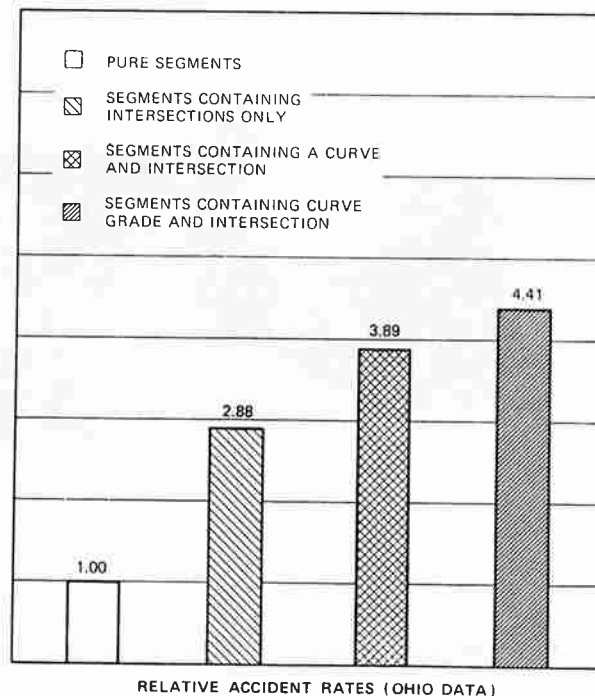
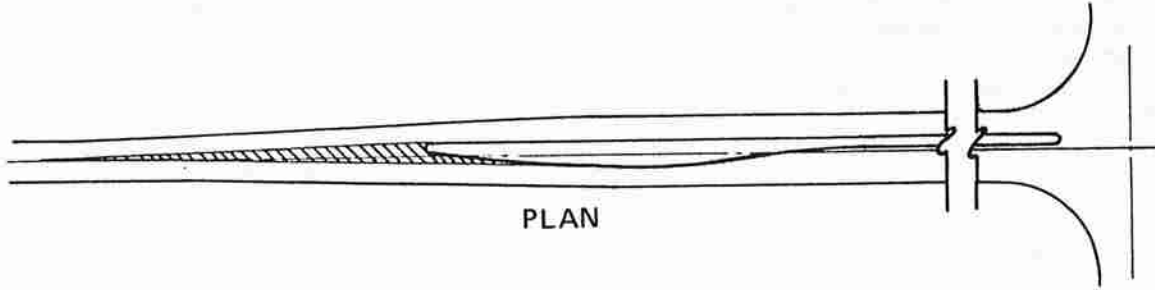

Figure 4-7. Effect of geometry on intersection accident rates. (Source: Ref. 4-4)

- Avoid locating intersections within or near sharp curves. A sharp curve is considered one close to AASHTO controlling curvature for a given design speed.
- In general, strive to maintain alinement that is as flat and tangent as is possible, particularly within a distance equivalent to 3 sec of driving time on each approach.

In unavoidable situations, special design treatments may be warranted. Consider, for example, Figure 4-8. Design of an intersection hidden behind the crest of a minimum vertical curve should be treated carefully. The designer should strive to provide drivers with advance visual notice of the intersection. In this case, widening out for the left-turn bay sooner than would



Start of channelization taper should be prior to crest of vertical curve to provide sufficient notice of the intersection.

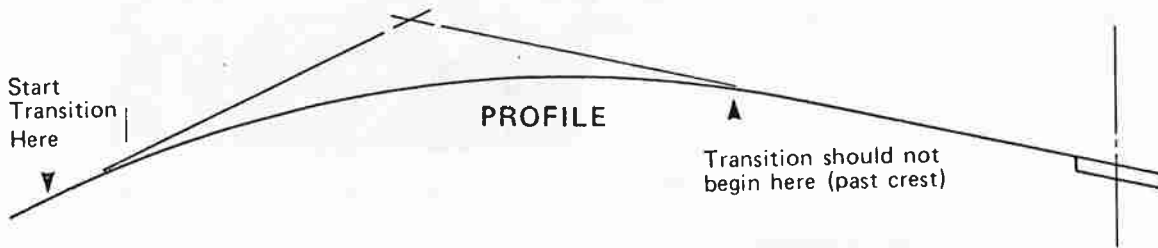

Extension of the channelization taper (above) provides the only visual cue of the intersection over the crest of the hill.

Figure 4-8. Adjustments to channelization to reflect vertical alignment.

normally be done, is a logical and effective design. Similarly, widening for channelization in advance of a curve is good practice. The "wrap-around" design shown in Figure 4-9 gives notice to the driver of the impending intersection, and spaces out the driving tasks (lane placement, speed adjustment, and steering).

Where intersections must occur within sharp curves, the designer should provide greater than minimum stopping sight distance. This is because cornering friction demands reduce friction available for braking.

### Reconstruction/Rehabilitation

Serious approach alignment problems are usually very costly to correct. Alteration of profile, horizontal alignment, or both requires new pavement, earthwork, drainage, and other costly construction items. Where cost is prohibitive or not justified by a location's accident experience, low-cost alternatives should be investigated. These may include:

- Installation or upgrading of advance warning signs.
- Spot widening to provide shoulders for collision avoidance; and/or left-turn lanes if none exist.
- Upgrading existing traffic control.

### WARRANTS/GUIDELINES FOR USE OF LEFT-TURN LANES

Perhaps the single most influential feature affecting an intersection's operations is the treatment of left-turn vehicles. Accommodation of left turns in many cases is the critical factor

in design. In terms of both level of service and intersection safety, provision for, or exclusion of, left-turn lanes has great influence.

Analysis of left turn-involved conflicts shows why their treatment is so critical. Left-turning vehicles conflict with (1) opposing through traffic, (2) crossing traffic, and (3) through traffic in the same direction. Not surprisingly, left turn-involved accidents (angle, rear-end, and same direction sideswipe) account for a significant percentage of intersection accidents at all types of intersections. And, even a cursory review of intersection capacity analysis reveals that the capacity of a signalized intersection is highly sensitive to how left turns are treated.

It appears from the above discussion that left-turn lanes are desirable at any intersection, under most conditions. Unfortunately, cost and space requirements mitigate against their inclusion in all situations. As with all other geometric elements, their need should be elevated against other design requirements and constraints. The following guidelines address the need for left-turn lanes in terms of the basic functional objectives of design.

A number of basic geometric and operational factors play a role in decisions to implement or include left-turn lanes at intersections. These are:

1. Types of highways (2-lane rural, divided, suburban arterial, local street, etc.), including functional class.
2. Prevailing speeds.
3. Traffic control.
4. Left turn volumes
5. Other intersection volumes.
6. Horizontal and vertical alignment.

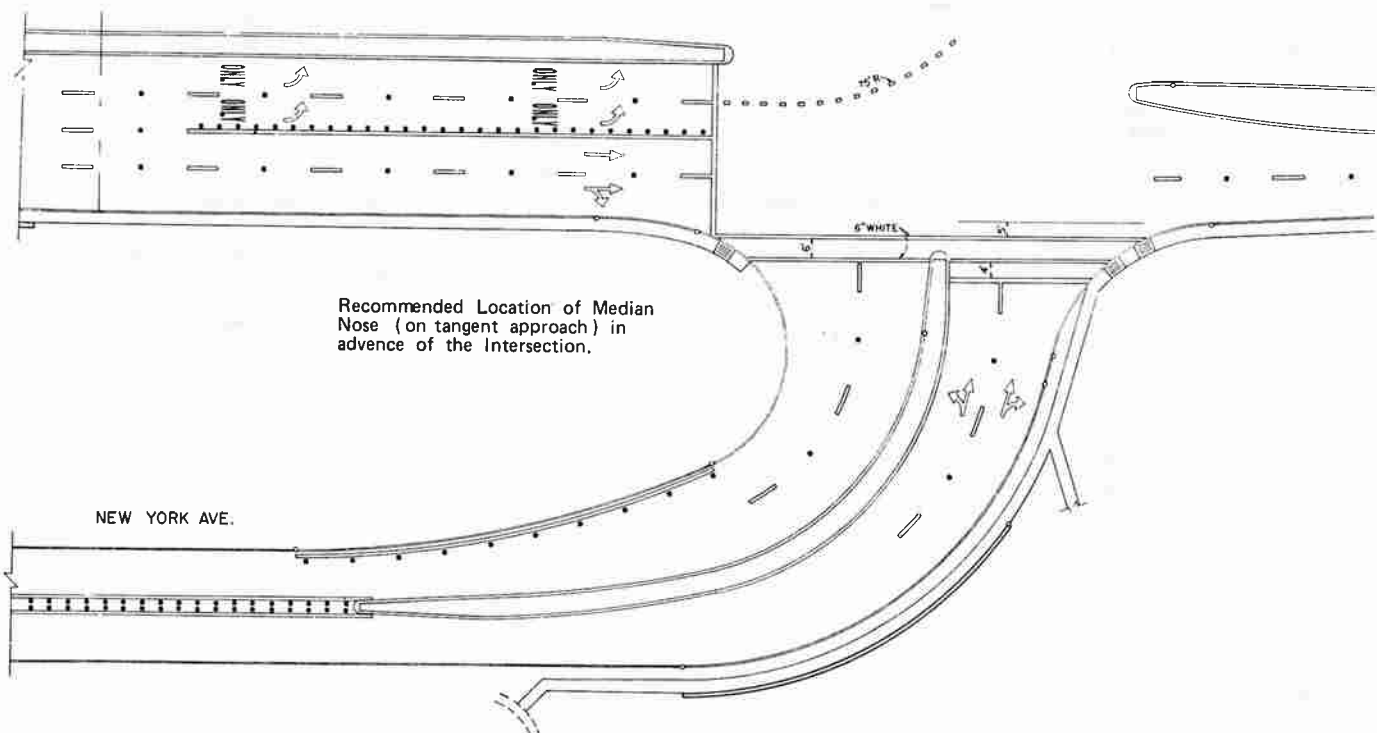

Figure 4-9. "Wrap-around" design for approaches to intersection on curves.

These considerations must be tempered by traffic engineering analyses for a given location. Capacity analyses of both signalized and unsignalized intersections and analysis of accidents involving left turning vehicles are essential to the decision.

Much accident research has been performed on the effectiveness of left-turn lanes in reducing intersection accident frequency. The results of one study (see Figure 4-10) show significant differences in accidents at both signalized and unsignalized intersections with and without exclusive left-turn lanes.

Current State of California analysis procedures, based on recent experience with 3R and traffic engineering improvements at intersections, are summarized in Table 4-3. Up to a one-third reduction in intersection accidents on a system-wide basis has been achieved by implementation of left-turn lanes.

A review of current design practice shows a range of considerations in decisions to provide for left-turn lanes. Table 4-4 summarizes the types of geometric and operational inputs in various state design standards and policies.

#### New Construction—Signalized Intersections

Left-turn lanes should be considered at the planning and preliminary design stages of any new signalized intersection. Special efforts should be made to include separate left-turn lanes because of their many advantages, which include their:

- Proven safety effectiveness.
- Effectiveness in improving intersection capacity.
- Flexibility in possible signal phasing schemes.
- Understanding of operation by the driving public.

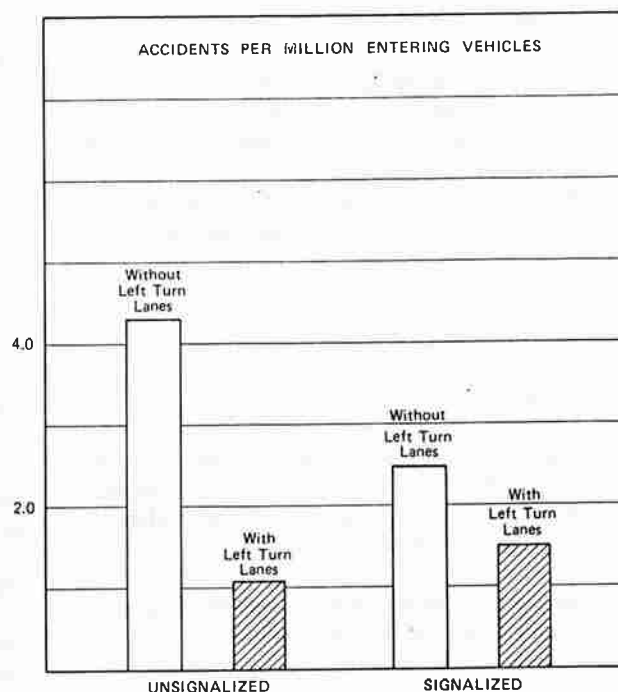

Figure 4-10. Effect of left-turn lanes on accident rates at intersections. (Source: Ref. 4-5)

Table 4-3. Safety effectiveness of left-turn channelization.

TYPE OF IMPROVEMENT	AVERAGE ACCIDENT REDUCTION	LIFE (YEARS)	MINIMUM ACCIDENT EXPERIENCE
<b>New Left-Turn Channelization</b>			
A. At signalized intersections			
1. With no left-turn phase	15% of all accidents	20/10*	5 or more last year
2. With left-turn phase	35% of all accidents	20/10*	4 or more last 3 years
B. At nonsignalized intersections	35% of all accidents	20/10*	4 or more last 3 years
C. Two-way left-turn lane	25% of all accidents	20/10*	4 or more last 3 years
<b>New Safety Lighting</b>	15% of night accidents	15	4 or more night accidents last 3 years.
<b>Curve Corrections</b>	50% of all accidents	20	4 or more last 3 years
<b>Shoulder Widening on Narrow 2-Lane Roads (24-ft wide or less)</b>			
<u>Width, Ft</u>	<u>AADT</u>		
28	≤ 3,000	15% of all accidents	4 or more last 3 years
32	≤ 5,000	35% of all accidents	
40	> 5,000	30% of all accidents	
<b>Passing Lanes for 2-Lane Roads</b>			
<u>Width, Ft</u>			
36	10% of all accidents	20	4 or more last 3 years
40	25% of all accidents	20	
42 to 44	30% of all accidents	20	

\* 20 years with standard geometrics where widening and/or other major improvements are accomplished.

10 years with substandard geometrics.

SOURCE: California Department of Transportation.

Signalized capacity analysis procedures should be used to determine lane arrangements. Because of the many variables involved, it is not feasible to develop guidelines for all conditions. However, the following general "rules of thumb" are useful in evaluating left-turn lane needs at specific locations.

Separate treatment of left turns will be required if (1) left-turn design volume exceeds 20 percent of total approach volumes; or (2) left-turn design volume exceeds 100 vehicles per hour in peak periods. This usually means either separate turning lanes, separate phases for left turns, or both. Figure 4-11 can also be used to evaluate the relative capacities of different lane arrangement and phasing schemes. (This figure is intended for reference as a general planning tool.) The three cases shown in Figure 4-11 reflect a range of left-turn demand conditions, which in turn determine signal phasing requirements.

Left-turn lanes may also be considered based on approach geometrics. If more than minimum stopping sight distance is not available to the intersection, it may be appropriate to include left-turn lanes regardless of demand volume. This may help reduce the rear-end accident potential.

At high speed, rural signalized intersections, separate left-turn lanes are considered necessary for safe operations. While capacity is not generally a problem, protection of queued left turning vehicles from through traffic is critical. Because the availability and cost of right-of-way is usually not a problem, separate left-turn lanes can in most cases be easily implemented.

#### **New Construction—Unsignalized Intersections**

Streets and highways with unsignalized intersections also may require left-turn lanes to facilitate traffic flow. The following guidelines are suggested:

1. Left-turn lanes should be considered at all median cross-overs on divided, high-speed highways.
2. Left-turn lanes should be provided at all unstopped (i.e., through) approaches of primary, high-speed rural highway intersections with other arterials or collectors.
3. Left-turn lanes are recommended at approaches to intersections for which the combination of through, left, and opposing volumes exceeds the warrants shown in Figure 4-12.
4. Left-turn lanes on stopped or secondary approaches should be provided based on analysis of the capacity and operations of the unsignalized intersection. Considerations include minimizing delays to right turning or through vehicles, and total approach capacity.

#### **Reconstruction/Rehabilitation**

Addition of left-turn lanes at existing intersections should be considered if safety or capacity problems occur, or if land-use changes are expected to produce significant shifts in local traffic patterns (such as increases in left-turn demand). Left-turn lanes can often be added within existing street widths by removing parking, narrowing of lanes or a combination of the two. Figure 4-13 shows an example of such treatment in an urban area.

The traffic volume guidelines described for new intersections are also appropriate for evaluating the need for left-turn lanes at existing intersections. In terms of safety, the following guidelines are suggested:

**Table 4-4. Warrants for left-turn lanes—summary of state practice and policies.**

Provide at high speed or high volume intersections—Hawaii, New Hampshire, New Jersey
Provide at all median openings of divided highways—Alaska, California, Colorado, Minnesota, Mississippi, Vermont, Ohio, Virginia, West Virginia
Provide when minimum volumes are exceeded—Iowa, Mississippi, North Carolina, Missouri, Utah, Wisconsin
Provide at signalized intersections when warranted by capacity analysis—many states

- Left-turn lanes should be considered at intersection approaches that experience a significant number of left turn-involved (rear-end, left turn angle, same direction sideswipe) accidents. A total of 4 or more such accidents in 12 months, or 6 or more in 24 months, is considered appropriate.

- Where room for separate left-turn lanes is not available, traffic control alternatives should be investigated. Such alternatives to left-turn lane implementation include split phasing at signalized intersections (i.e., operating each approach individually) or prohibition of left turns.

#### **DESIGN OF LEFT-TURN LANES**

Design of left-turn lanes is directly tied to their intended functions, the characteristics of the highway, and local constraints. Left-turn lanes provide one or more of the following functions:

1. A means of safe deceleration outside the high-speed through lanes.
2. A separate storage area for left turns so that signal phasing can be optimized and intersection delay minimized.
3. A means of separating movements at unsignalized intersections to reduce left turn impacts on other traffic flows.

The design elements of left-turn lanes, summarized in Figure 4-14 include the approach taper, bay taper, length of lane, width of lane, and departure taper.

#### **Approach Tapers**

Approach tapers direct traffic to the right, and provide space for development of the turn lane. Their design should smoothly direct all vehicles in the through lanes without the need for abrupt steering. Well-marked approach tapers have the added benefit of providing to all drivers visual notice of the intersection.

#### **Bay Tapers**

Bay tapers direct left-turning traffic from the through lanes to the left-turn lane. Their design should not be so short as to promote abrupt entry to the lane; nor should it be so long that through drivers unintentionally wander into the lane.

On low speed streets, or in areas with limited space, the bay and approach tapers can be combined. The total taper produces

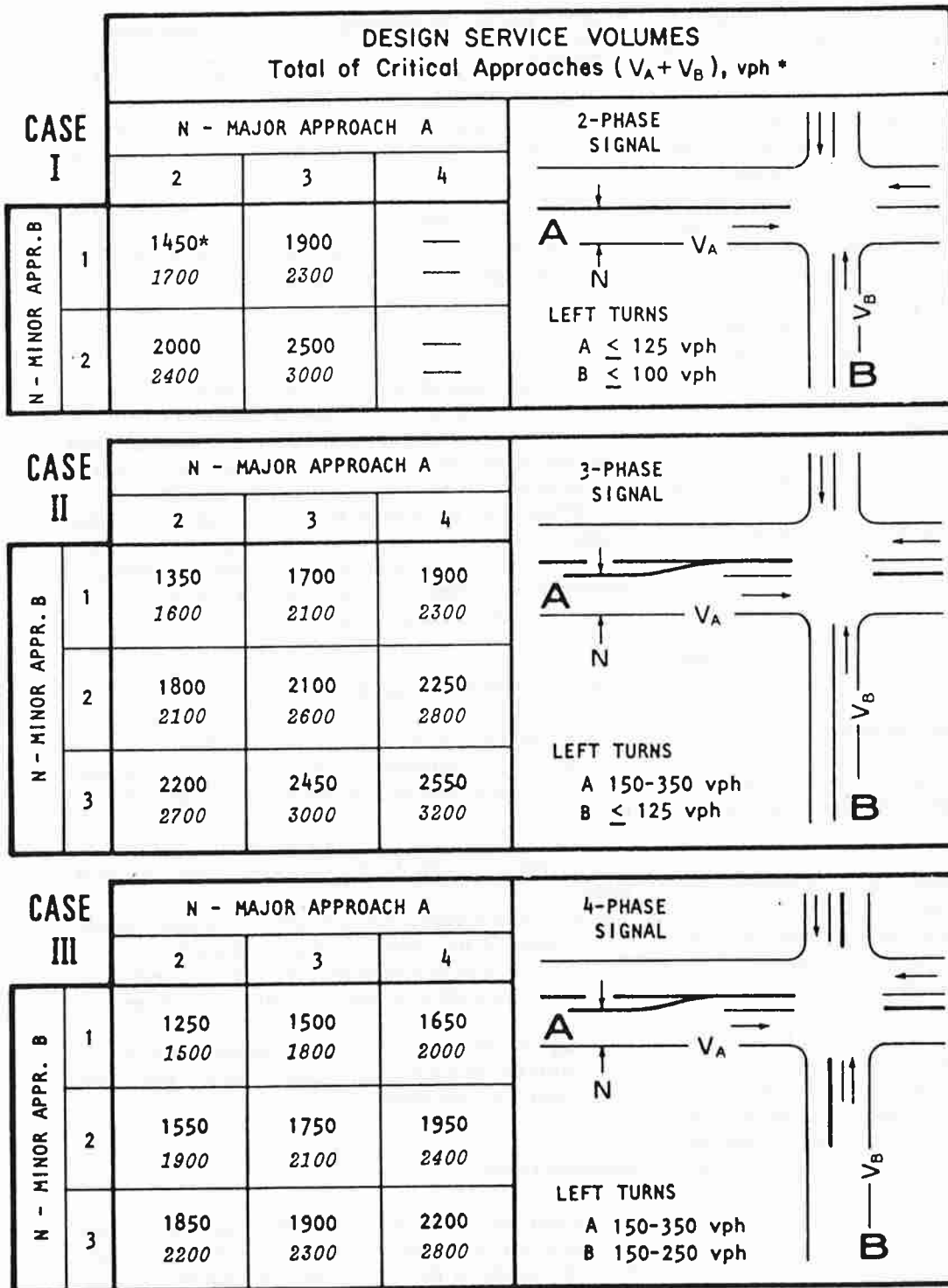

NOTE: N - Number of basic traffic lanes (one direction) on approach, exclusive of turning lanes;  
2-, 3- and 4-phase representative of typical geometric and volume condition, and not necessarily the phasing required.

\* Sum of two one-way approach volumes--vph, during design hour; upper number--service level C; (in italics)--capacity.

Figure 4-11. General capacity guidelines for consideration of left-turn lanes at signalized intersections. (Source: Ref. 4-6)



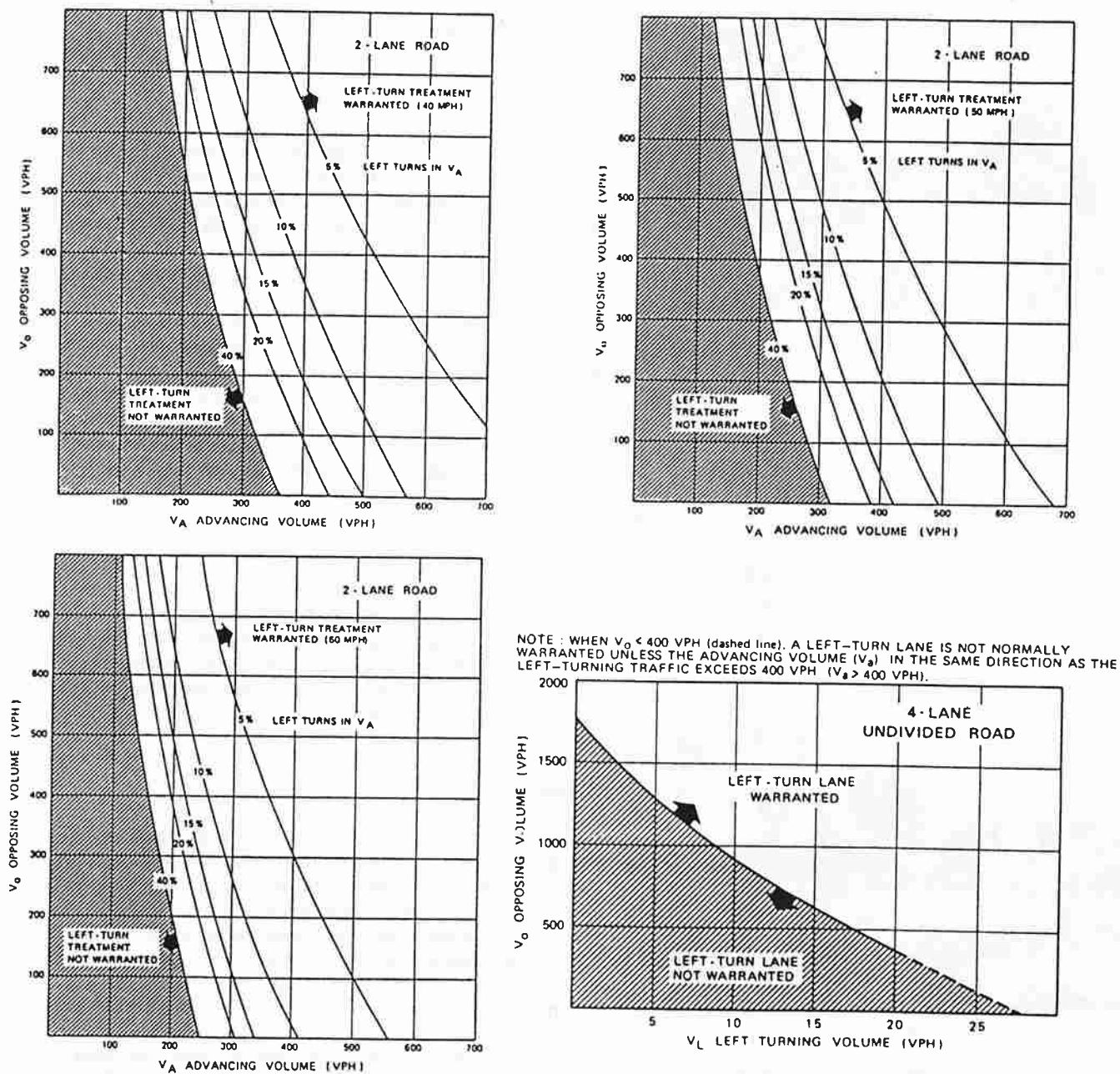

Figure 4-12. Volume warrants for left-turn lanes at unsignalized intersections. (Source: Ref. 4-7)

a partially shadowed left-turn lane, as illustrated in Figure 4-14. With partially shadowed left-turn lanes, the offset created by the approach taper does not entirely protect or “shadow” the turn lane.

**Length of Lane**

The left-turn lane length is among the most important design element of left-turn lanes. Its design is directly tied to the particular function of the lane, which is based on prevailing speeds,

traffic volumes, and traffic control. The design basis for length can be deceleration, storage, or a combination of both.

Left-turn lanes on high-speed highways should be designed to accommodate vehicle deceleration and braking. The channelization principle of removing slow or decelerating vehicles from through traffic applies at such locations. Figure 4-15 illustrates the functional basis for design of deceleration-based left-turn lanes according to AASHTO. The assumed “reasonable” driver behavior includes deceleration in gear for 3 sec., followed by comfortable braking completely within the turning lane. Where constraints exist and speeds are moderate, an al-

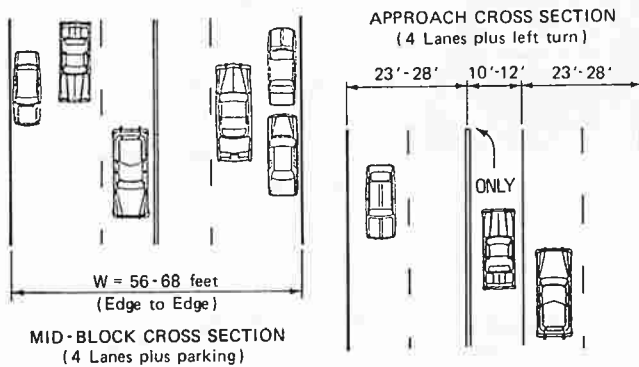

MIDBLOCK

MID-BLOCK CROSS SECTION  
(4 Lanes plus parking)APPROACH CROSS SECTION  
(4 Lanes plus left turn)

APPROACH

Figure 4-13. Addition of left-turn lanes within existing cross section.

ternative deceleration-based functional design length, also shown in Figure 4-15, can be used. Here, braking is assumed to begin where two-thirds of the lane width is developed.

At intersections with high approach volumes the design length should be based on the rate of arrivals (demand volume) during an appropriate time period. Here, the functional requirements of the lane primarily involve storage of queued vehicles outside the through traffic lanes. Where storage is the key functional concern, the following elements affect appropriate lane lengths:

1. Arrival rate of left turns.
2. Arrival rate of through vehicles.
3. Vehicle mix.
4. Traffic signal cycle length.

The lane should be long enough to operate independently of through traffic lanes. As Figure 4-16 shows, queue lengths of both the left turn demand as well as through traffic should be checked. The former is important to avoid left turns backing up into through traffic; the latter is necessary to avoid blocking of access to the left-turn lane by queued through traffic.

Certain turning lanes should be designed for a combination of deceleration and storage. Signalized intersections on high-speed rural highways and moderate speed suburban arterials are included.

In all cases, the minimum length of lane should be based on storage of one vehicle, typically the largest vehicle expected to use the approach. As this is usually a WB-50 or similar large truck, appropriate absolute minimum left turn lengths are 50 to 75 ft.

#### Width of Lane

Left-turn lane widths should reflect the speed, volume, and vehicle mix. Although 12-ft widths are desirable, lesser widths may function effectively and safely. Absolute minimum widths of 9 ft should be used only in unusual circumstances, and only on low speed streets with minor truck volumes.

#### Departure Tapers

The departure transition from the intersection should be designed in concert with the left-turn lane on the opposite approach. Abrupt tapers should be avoided so that smooth acceleration away from the intersection is promoted. The departure taper should begin opposite the beginning of the left-turn lane, and continue to a point at least opposite the approach nose of raised median channelization is recommended whenever possible.

Figures 4-17, 4-18, and 4-19 summarize recommended design values for the elements that comprise left-turn lanes. Table 4-5 describes suggested lane widths for a range of typical conditions.

#### SPECIAL LEFT-TURN DESIGNS

Many intersection and corridor operational problems can be traced to difficulties of accommodating left-turn demand. Such difficulties involve both demand volume and the frequency of demand along a corridor. A number of channelization techniques have been developed and refined in recent years to address these unusual or severe left-turn volumes. These techniques include (1) use of double left-turn lanes; (2) use of continuous two-way left-turn lanes in medians of arterial highways, and (3) special left-turn alternatives such as at-grade loops, jughandles, and median crossovers. In this section, guidelines for the application and design of these special techniques are presented.

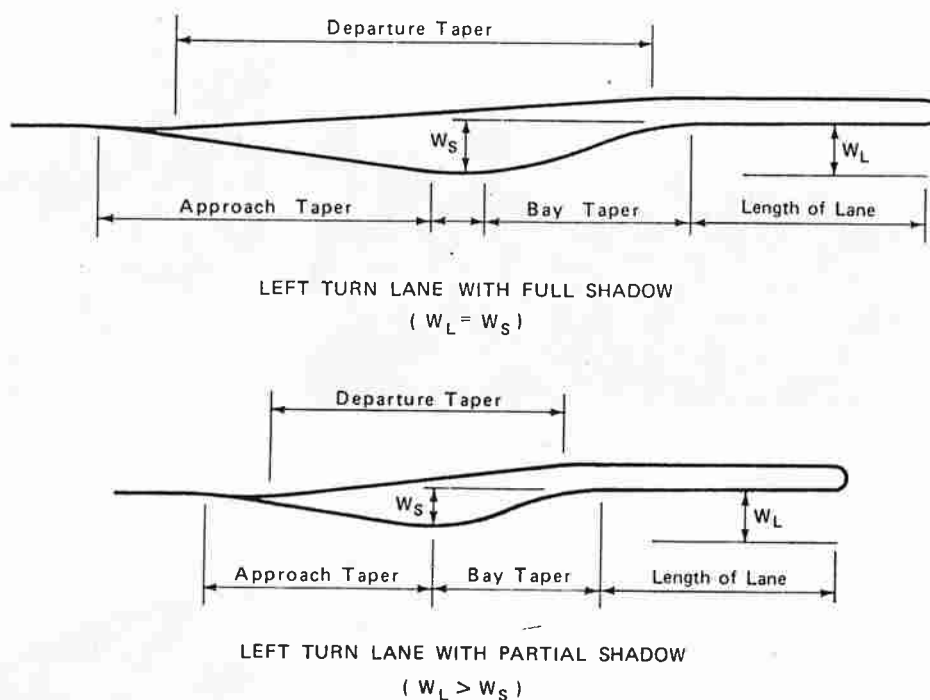

Figure 4-14. Elements of left-turn lane design.

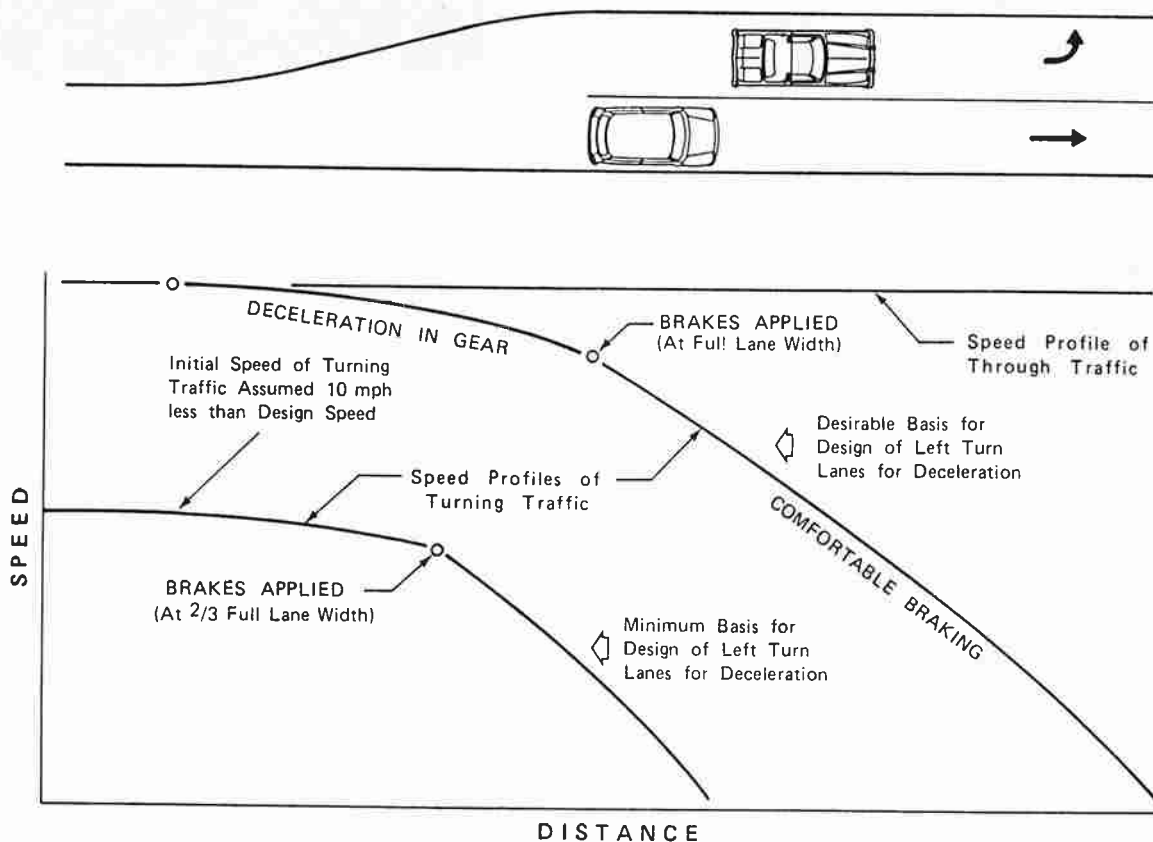
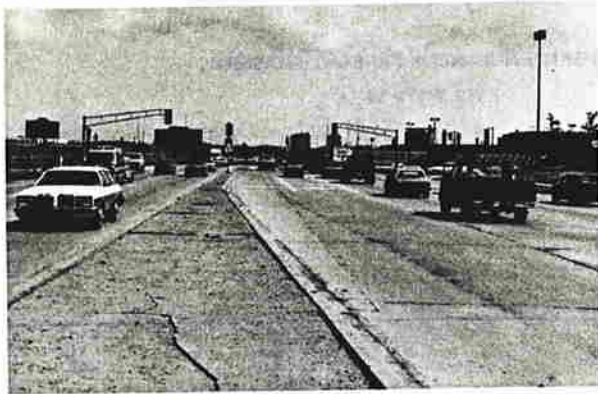

Figure 4-15. Functional bases for design of left-turn lanes for deceleration.



Left turn lanes should be long enough to enable approaching vehicles to bypass queues in through lanes, and to accommodate left turn arrivals within the lane.



Sufficient length for double left turn lanes is particularly important. Signal phasing and capacity considerations generally require independent operation of these lanes from through lanes.

This left turn lane is too short to accommodate queues of any magnitude in either lane.

Figure 4-16. Operational effects of left-turn lane length.

TYPE OF TRAFFIC CONTROL	DESIGN SPEED OF HIGHWAY					
	50-60 mph Traffic Volume*		40-45 mph Traffic Volume*		30-35 mph Traffic Volume*	
	High	Low	High	Low	High	Low
Traffic Signal	Deceleration and Storage		Deceleration and Storage		Storage	
Stop Control (Stopped Approach)	Storage		Storage		Storage	
Stop Control (Through Approach)	Decel-eration and Storage	Decel-eration	Decel-eration and Storage	Decel-eration	Storage	

\* Left turn demand volume

Figure 4-17. Recommended functional basis for design length of left-turn lanes.

$L_d/b$  -- Length of Taper and Lane For Deceleration and Braking

Functional Basis: To provide sufficient length for a vehicle to decelerate and brake entirely outside the through traffic lanes

Desirable Design: Deceleration in gear for 3 seconds (occurs over bay taper) followed by comfortable braking to a stopped position

Design Values For  $L_d/b$

S--Speed (mph)	Total	Length Lane (ft)	Bay Taper
30	235	90	(145)
40	315	125	(190)
50	435	195	(240)
60	530	240	(290)

Minimum Design: Braking begins at 2/3 full lane width, with minimum 50-foot storage. For low speeds only, the following values apply:

Design Values For $L_d/b$			
S--Speed (mph)	Total	Length Lane (ft)	Bay Taper
30	230	50	(180)
35	250	70	(180)
40	280	100	(180)
45	320	140	(180)

$L_s$  -- Length of Lane For Storage (Full Width Lane)

Functional Basis: To provide sufficient length for a reasonable number of vehicles to queue within the lane without affecting other lanes

Desirable Design: Based on twice the mean arrival rate (per cycle for signals, per 2-minute period for stop control) during the peak hour of traffic

Minimum Design: Based on mean arrival rate, with minimum storage for one vehicle

$L_s$ for Stop Control		$L_s$ for Traffic Signal Control	
DHV (vph)	$L_s$ (ft)		
$\leq 60$	50-75		
61-120	100		
121-180	150		
$> 180$	200 or more		

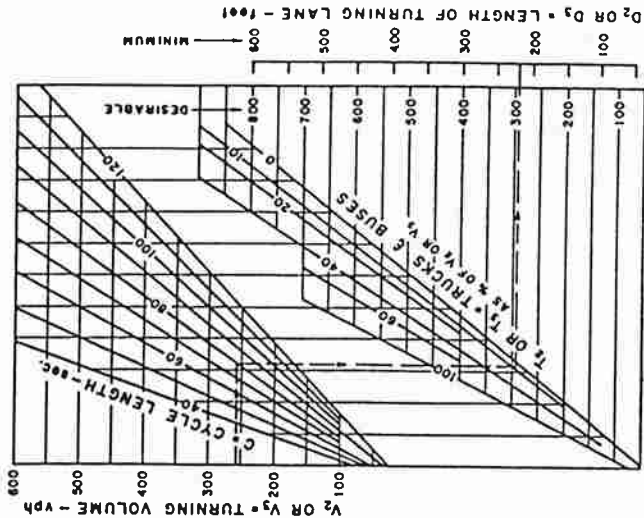

Figure 4-18. Guidelines for design lengths of left-turn lanes.

T<sub>a</sub> -- Approach Taper Design

Functional Basis: To provide a smooth lateral transition for all vehicles approaching the interesection

Form of Alinement: Tangent

Desirable Design: Provide a fully shadowed lane ( $W_a > W_l$ ). Recommended for high speed intersections and intersections in rural and open urban areas with no space constraints.

$$T_a = \frac{W_l S^2}{60}$$

$W_l$  = Width of Lane (ft)

$S$  = Speed (mph)

Typical Values for T<sub>a</sub>\*

S--Speed (mph)	W <sub>l</sub> -- Width of Lane (ft)
	11      11.5      12
30	165      170      180
40	295      305      320
50	460      480      500
60	660      690      720

\* Rounded to nearest 5 ft

Minimum Design: Provide a partially shadowed lane (see Figure 4.14) with  $W_s < W_l$ . Design as follows:

$$T_a = W_s S \quad \begin{matrix} W_s = \text{Offset (ft)} \\ S = \text{Speed (mph)} \end{matrix}$$

As a minimum, a 10:1 taper ratio should be used.

Figure 4-19. Guidelines for design tapers of left-turn lanes. (Source: Refs. 4-9, 4-10)

T<sub>b</sub> -- Bay Taper Design

Functional Basis: To direct left-turning vehicles into the turn lane

Form of Alinement: Tangent; or reverse curves with 1/3 of the total length comprised of a central tangent

Desirable Design: For fully shadowed left turn lane

$$T_b = \frac{W_l S}{2.5}$$

$W_l$  = Width of Lane

$S$  = Speed (mph)

Typical Values for T<sub>b</sub>\*

S--Speed (mph)	W <sub>l</sub> -- Width of Lane (ft)
	11      11.5      12
30	130      140      145
40	175      185      190
50	220      230      240
60	265      275      290

\* Rounded to nearest 5 ft

Minimum Design: Taper ratios of 8:1 can be used for tangent bay tapers. For constrained locations, ratios as low as 4:1 can be used with painted channelization.

**Table 4-5. Appropriate design widths of left-turn lanes.**

LOCATION AND SPEED	FUNCTIONAL CLASSIFICATION	LEFT-TURN LANE WIDTH (FT)
Rural (high speed)	Primary and minor arterials	12—new design 11—minimum for 3R design
Suburban (high and moderate speed)	Primary and minor arterials	11 – 12
Suburban (moderate speed)	Collectors	10 – 12
Urban (moderate and low speed)	Arterials	11 – 12—new design 10—minimum for 3R design
	Collectors	9 – 12 (9 ft is appropriate only in unusual cases)

### Double Left-Turn Lanes—Guidelines For Use

Double left-turn lanes have been applied successfully nationwide at locations with severe capacity or operational problems. Their applicability is generally greatest at high-volume intersections with significant left turning volume in one or more directions. Often, double left-turn lanes are necessary for overall intersection capacity reasons.

Double left-turn lanes should be considered at any signalized intersection with high design hour demand volumes for left turns. As a general “rule-of-thumb,” left turn demands of 300 vph or more are appropriate for consideration of double left-turn lanes.

The need or desirability of double lefts should be determined from typical capacity analyses. Alternative lane arrangement and signal phasing schemes should be tested. In terms of capacity, double left-turn lanes operate at about 1.8 times the capacity of single left-turn lanes.

Because of the high volumes associated with double left-turn lanes, and their relatively unusual nature, fully protected signal phasing is generally warranted.

### Design of Double Left-Turn Lanes

Years of experience and research have provided a number of design guidelines for double left-turn lanes:

- The throat width for turning traffic is the most important design element. Drivers are most comfortable with extra space between the turning queues of traffic. Because of the offtracking characteristics of vehicles and the relative difficulty of two-abreast turns, a 36-ft throat width is desirable for acceptance of two lanes of turning traffic. In constrained situations, 30-ft throat widths are acceptable minimums.

- Guiding pavement markings to separate the turning lanes are recommended. The MUTCD recommends 2-ft long dashed lines with 4-ft gaps to channelize turning traffic. These channelization lines should be carefully laid out to reflect offtracking and driving characteristics.

- Designers should carefully sign and mark double turning lanes to prevent inadvertent “trapping” of through traffic. Fully shadowed lanes should be designed wherever possible. Up to a

full lane width of recovery area should be provided in the median opposite the double turning lane for recovery of trapped vehicles.

- Designers should check for possible conflicts involving left turns opposing double left turns. Where such simultaneous movements occur, special pavement markings to separate opposing turns may be necessary.

Figures 4-20 and 4-21 illustrate the foregoing design principles.

### Continuous Two-Way Left-Turn Lanes (COTWLTL)

A major problem on many suburban and urban arterials is that of midblock left turns. Demands for access to businesses and private residences often create serious congestion and/or safety problems. Left turn conflicts with both opposing and same direction (rear end) vehicles can seriously degrade corridor operations.

The problem is often not solvable by construction of regularly spaced left turn lanes. Driveway spacing and turning volumes into any one driveway often preclude this solution. Complete access restrictions are often not possible either, because they create an undue burden on residents of the corridor.

Many agencies have turned to continuous two-way left-turn lanes (COTWLTL) to solve the left turn conflict problem while maintaining access to roadside activities. Recent experience with COTWLTL suggests they are safe and cost-effective.

### Guidelines For Implementation of COTWLTL

COTWLTL should be considered whenever actual or potential midblock conflicts occur. The following information could indicate the need for COTWLTL:

- Midblock accident history involving left turning vehicles.
- Closely spaced driveways.
- Strip commercial or multiple-unit residential land use along the corridor.

A number of studies have evaluated the cost-effectiveness of COTWLTL. The following warrants/guidelines are suggested for their application:

#### *Average Daily Traffic Through Volumes*

10,000 to 20,000 vehicles per day for existing 4-lane highways

5,000 to 12,000 vehicles per day for existing 2-lane highways

#### *Turning Volumes*

70 midblock left turns per 1,000 ft during peak hour  
left-turn peak-hour volume of 20 percent or more of total volume

#### *Minimum Length*

1,000 ft or 2 to 3 blocks is considered a minimum reasonable length

### Design of COTWLTL

COTWLTL applies to a range of highways, from urban streets to suburban arterials. In general, COTWLTL can be considered when operating speeds are 50 mph or less.

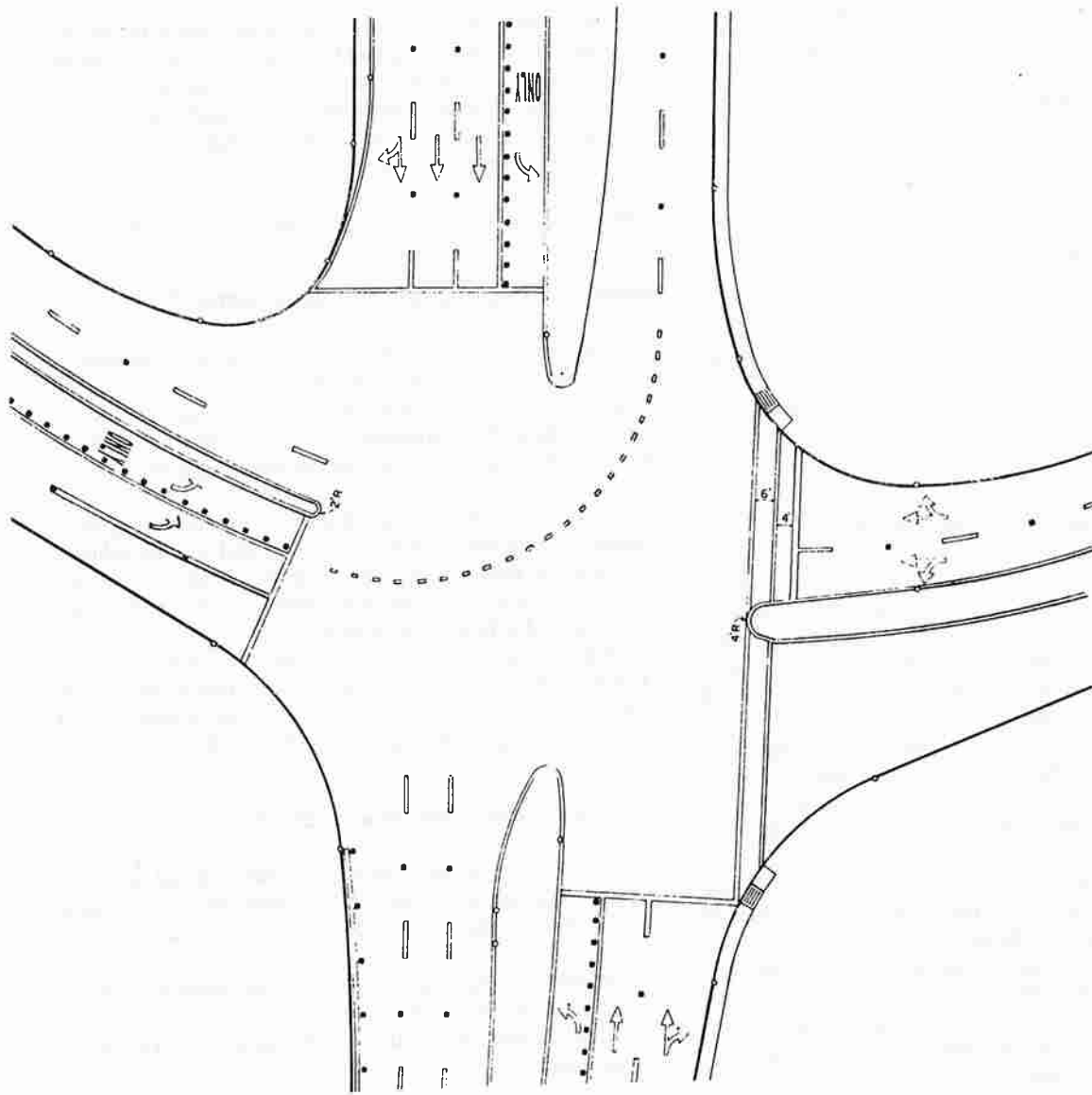

*Wide throat widths enable comfortable placement of vehicles turning two abreast.*

*Figure 4-20. Design of double left-turn lanes.*



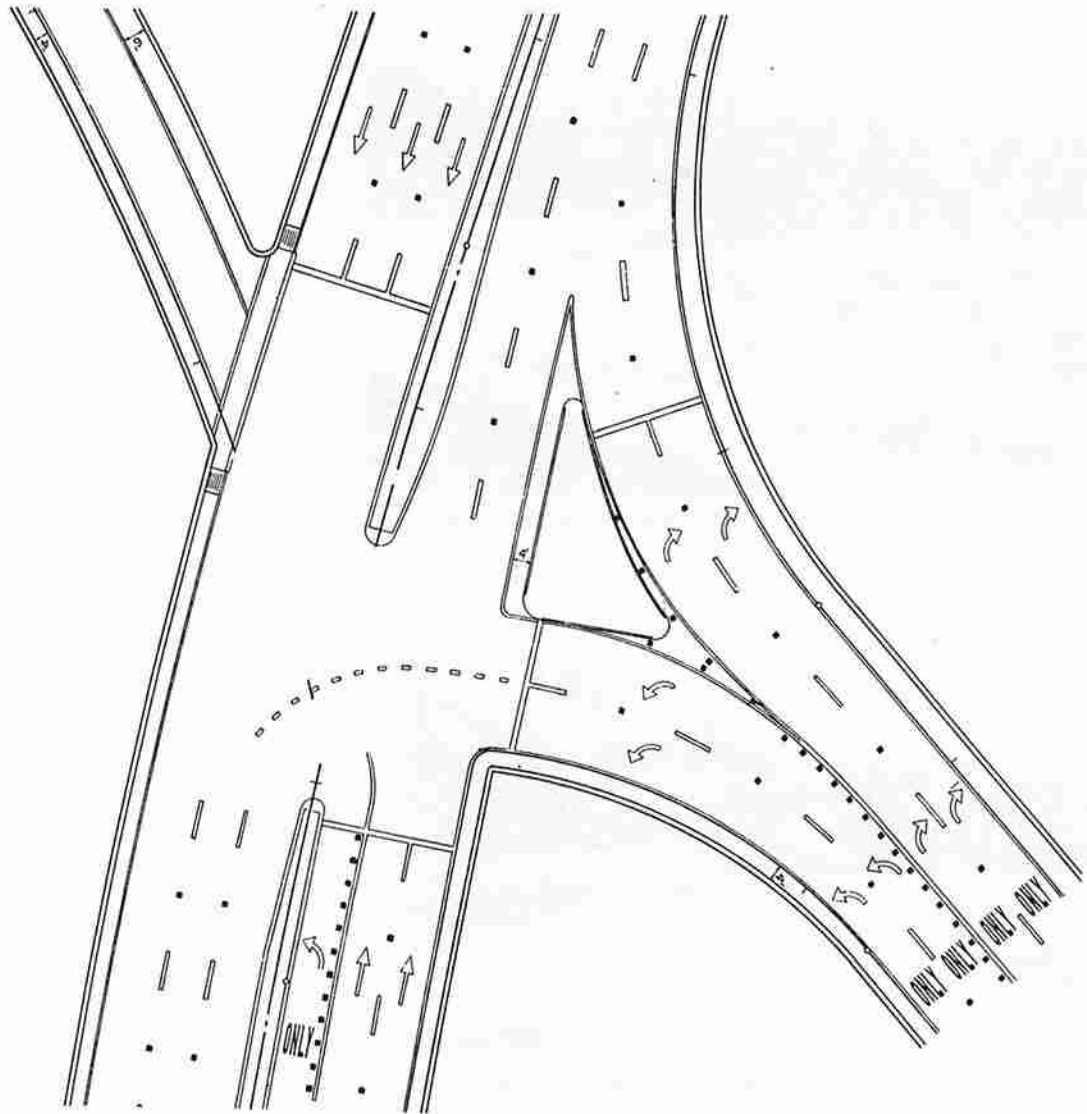

*Special pavement markings and application of channelization principles assist traffic in safely completing the double left turn movement. Here, the approach roadway is transition to a right-turn crossing, and the double turn is guided into a full, 3-lane width.*

*Figure 4-20. Continued*

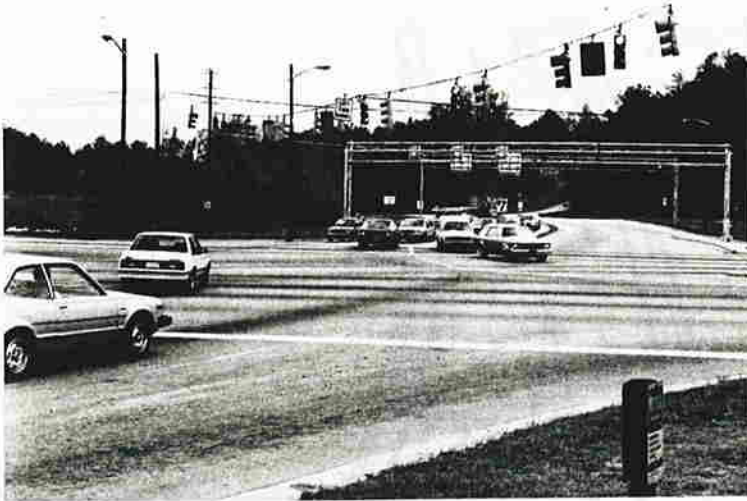

*Good design promotes simultaneous discharge from both lanes.*



*Note the offset between turning vehicles.*



*Large vehicles generally will turn in the outside lane.*

*Figure 4-21. Operational characteristics of double left-turn lanes.*

Good design of COTWLTL should involve evaluation of speed, vehicle mix, roadside characteristics, and local conditions. Lane widths of 10 to 16 ft have been successfully used. Table 4-6 gives suggested lane widths for various types of highways.

New designs incorporating COTWLTL should strive for 12-ft to 14-ft lane widths. Conversion of existing cross sections is generally more constrained; however, narrow widths should be avoided except for low-speed streets. Widths of 15 to 16 ft may be appropriate for corridors with large volumes of left-turning trucks. However, such widths can generate shared use of the lane (i.e., side-by-side) by opposing drivers, which is potentially hazardous.

COTWLTL should be marked according to the MUTCD. Overhead signing at regular intervals is recommended to remind drivers of the proper lane use.

### Other Left Turn Treatments

In some cases, the highway geometry and traffic characteristics prevent efficient operation of intersections with direct left turns. A number of design agencies have implemented special solutions to such problems. These include directional crossovers to handle left turn demand, jug handles, and at-grade loops.

Figure 4-22 depicts special left turn alternatives. Application of these treatments may be appropriate under the following circumstances:

1. Heavy left-turn demand exists.
2. Heavy through-traffic demand exists on both highways, requiring much of the traffic signal's green time.
3. Right-of-way in one or more quadrants is available; or median width is available.
4. Sufficient spacing exists to adjacent signalized intersections.

The intent of special design treatments is to eliminate the left turn movement and its required signal phase, without prohibiting the actual movement. Traffic is diverted through the intersection as a right turn or through movement, whereupon it completes the "left turn" on the cross street, again as either a right or through movement.

The operational advantages of these designs are that they enable simple phasing, thereby facilitating signal progression schemes and corridor capacity. Potential problems with these designs relate to the weaving movement required in some cases, and the result that "left turn" traffic must go through the intersection twice.

In rural areas with low left turn volumes, a different type of design is often used in lieu of left turn channelization. Bypass lanes, applicable to the through approach at a T-type intersection, can separate the infrequent left turns queued inside the through lanes.

### Other Corridor Alternatives

Other alternatives for handling left-turn demand along a corridor are presented in the section on "Access Control."

### EXCLUSIVE RIGHT-TURN LANES

The use of right-turn lanes at intersections can significantly affect operations. Improved level of service at signalized inter-

Table 4-6. Lane widths for COTWLTL.

PREVAILING SPEED	LANE USE/VEHICLE TYPE	APPROPRIATE WIDTH OF LANE
25-30 mph	Residential, business (passenger cars)	10 ft absolute minimum; 12 ft desirable
30-40 mph	Business (passenger cars, some trucks)	12 ft minimum 14 ft desirable
	Industrial (many large trucks)	14 ft to 16 ft
40-50 mph	Business	14 ft desirable

sections can result from addition of a separate right-turn lane to the design, or from conversion of a through lane to a right-turn lane. At uncontrolled or through approaches, right-turn lanes can safely remove deceleration, turning vehicles from the through lanes.

In terms of safety, special treatment for right-turning vehicles is less critical than for left turns. Right turns involve fewer and less severe conflicts, and tend to have lesser influence on through traffic flows at intersections. Nevertheless, there are conditions for which the added cost of providing exclusive right-turn lanes is fully justified by improvements to traffic flow. Factors to consider include:

- In urban areas, peak or design hour volume of right turns; right-turning rear-end accidents; pedestrian crossing volumes.
- In rural areas and on high-speed suburban-type facilities, volume of right turns; speed of the highway; adjacent land use.

Previous research offers little indication of the expected safety effectiveness of exclusive right-turn lanes. Clearly, provision for right-turn lanes would be expected to address conflicts involving right turning vehicles. These would include rear-end conflicts with following vehicles, side-swipe conflicts with through vehicles, and conflicts with pedestrians crossing the street being entered by right turning vehicles.

Current nationwide practice in providing for exclusive right-turn lanes is summarized in Table 4-7. No specific warrants or guidelines are apparent for low speed, urban intersections. Engineers generally rely on capacity analyses and accident experience when considering right-turn lanes. In rural areas, focus is primarily on a combination of through and right-turning volume.

### Design Guidelines for New Construction

Provision for right-turn lanes exclusive of through lanes should depend on traffic volumes, available room for the additional lane, and capacity considerations. At urban intersections, the following factors may contribute to the need for a right-turn lane:

1. Significant percentage of approach volume as right-turning volume.
2. Presence of pedestrians who would conflict with right-turning vehicles.
3. Severe skew or grade that increases the difficulty of right turns.

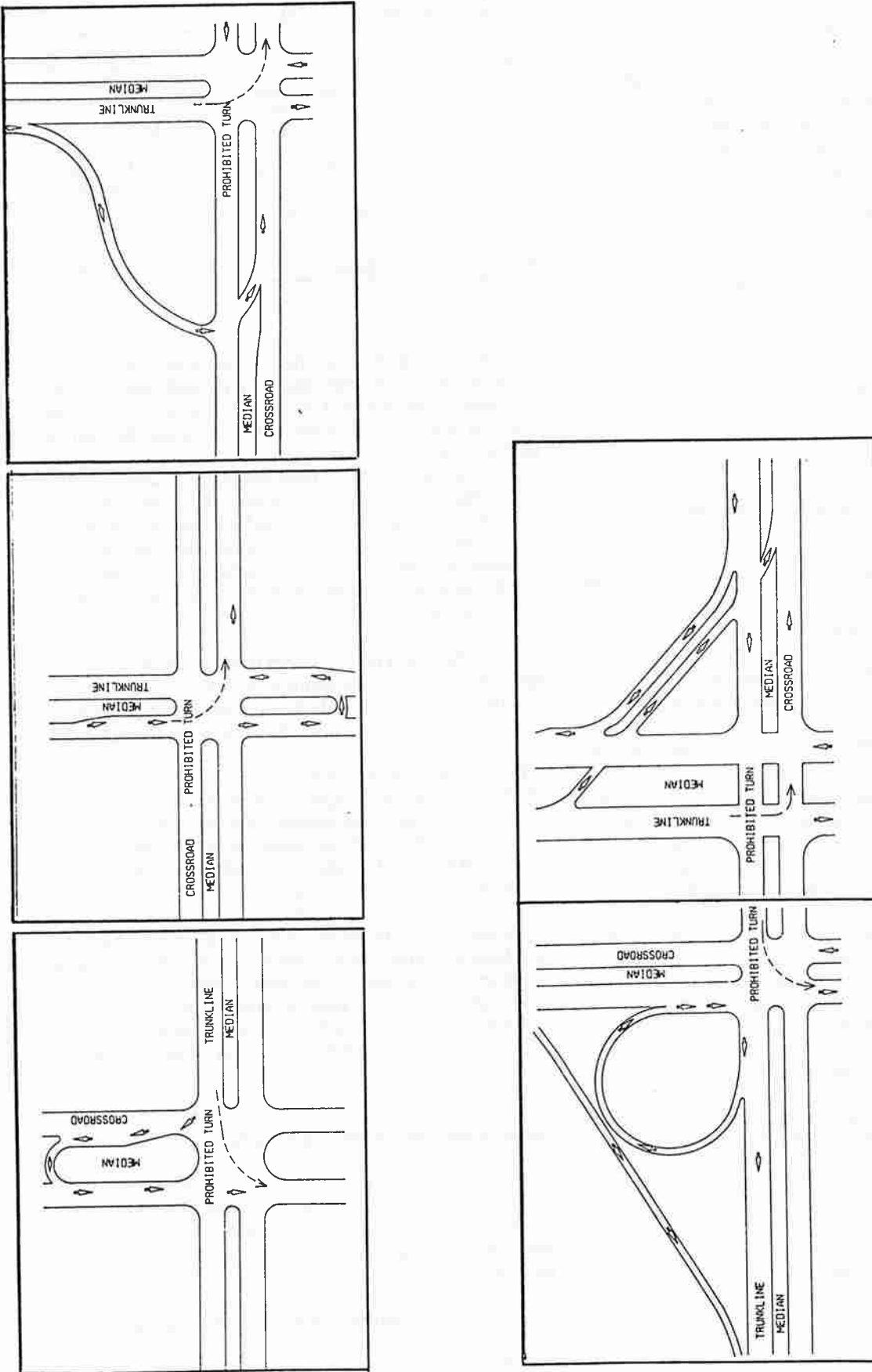

Figure 4-22. Alternative treatments to conventional exclusive left-turn lanes. (Source: Michigan Department of Transportation)

Right-turn lanes can be incorporated within standard cross sections that include parking lanes. Removal of parking upstream of the intersection creates the opportunity to develop an exclusive right-turn lane.

At suburban and high-speed rural intersections, design concerns should focus on right-turn lanes as a solution to potential rear-end conflicts. High volumes of right turns generated by shopping centers, developments, and office buildings may warrant construction of right-turn lanes of multilane highways. For 2-lane highways, volume warrants for right turns are generally much lower. This is because right and through vehicles are restricted to a single lane. Figure 4-23 and Table 4-7 can be consulted to provide guidance for including right-turn lanes.

Additional factors not explicitly covered in the volume warrants, but clearly appropriate in considering right-turn lanes, include:

1. Geometrics (both horizontal and vertical) that significantly affect the ease or speed of the right-turn maneuver.
2. Marked routes that make a turn (*Note:* these may require right-turn lanes regardless of volume considerations; driver expectations are important in this case).
3. Minimum stopping sight distance to the intersection (versus desirable stopping sight or decision sight distance).

### Reconstruction/Rehabilitation

Analysis of site-specific accident data may lead to the decision to add a right-turn lane to a location. In urban areas, a predominance of rear-end sideswipe accidents involving right-turning vehicles could be treated with the addition of an exclusive lane. In rural areas, frequent high-speed rear-end accidents may warrant addition of a right-turn lane. In both cases, availability of right-of-way and costs of construction would determine the feasibility or desirability of right-turn lane additions.

### DESIGN OF RIGHT-TURN LANES

Design of right-turn lanes is similar to that of left-turn lanes. A right-turn lane can fulfill one or more of the following functions:

1. A means of safe deceleration outside the high-speed through lanes for right-turning traffic.
2. A storage area for right-turning vehicles to assist in optimization of traffic signal phasing.
3. A means of separating right-turning vehicles from other traffic at STOP-controlled intersection approaches.

Design elements of interest include the departure taper, length of lane, width of lane, and recovery area.

The functional requirements for right-turn lane design are similar to those for left-turn lanes. When the principle function is to provide for deceleration, the design should be based on deceleration in gear for 3 sec, followed by comfortable braking. With right turns it may be appropriate to assume that braking continues not to a stop as with left-turn lanes, but rather to the design speed of the turning roadway or corner radius.

Design for storage at signalized intersections is based on arrival rates for right-turn volumes and departure conditions (i.e.,

Table 4-7. Summary of state design practice in providing right-turn lanes on rural highways.

STATE	CONDITIONS WARRANTING RIGHT TURN LANE OFF MAJOR (THROUGH) HIGHWAY		
	THROUGH VOLUME	RIGHT-TURN VOLUME	HIGHWAY CONDITIONS
Alaska	N/A	DHV = 25 vph	
Idaho	DHV = 200 vph	DHV = 5 vph	2-lane
Michigan	N/A	ADT = 600 vpd	2-lane
Minnesota	ADT = 1,500 vpd	All	Des. speed > 45 mph
Utah	DHV = 300 vph	crossroad ADT = 100 vpd	2-lane
Virginia	DHV = 500 All	DHV = 40 vph DHV = 120 vph	2-lane, Des. speed > 45 mph
	DHV = 1200 vph All	DHV = 40 vph DHV = 90 vph	4-lane
West Virginia	DHV = 500 vph	DHV = 250 vph	Divided highways
Wisconsin	ADT = 2500 vpd	crossroad ADT = 1000 vpd	2-lane

DHV—design hourly volume  
ADT—average daily traffic

available green time, cycle length). In designing for storage, the adjacent through lane volume will often control the desirable length. This is because right-turn lanes have greater capacity due to greater signal timing flexibility and potential for right-turn-on-red.

Right-turn lanes at stopped approaches should be of sufficient length to enable right-turning vehicles to bypass queued through and/or left-turning vehicles. This allows the higher capacity right-turn movement to operate independently of other stopped movements.

### Lane Widths

Lane width requirements for right-turn lanes are similar to those for other lanes. In general, 12-ft lanes are desirable, although widths as low as 9 ft may be used in severely constrained situations. Narrower lane widths often result from conversion of a parking lane (typically 8 to 10 ft wide) to a right-turn lane at an intersection.

Designers should be aware of the operational effects of barrier-type curbs on drivers. Right-turn lanes adjacent to such curbs should be designed to full widths (11 to 13 ft) to negate the constricting effects of the curb. This is particularly important if the gutter width dimension is nominal.

### Design Values

Figure 4-24 summarizes the functional requirements and resulting design values for design of right-turn lanes.

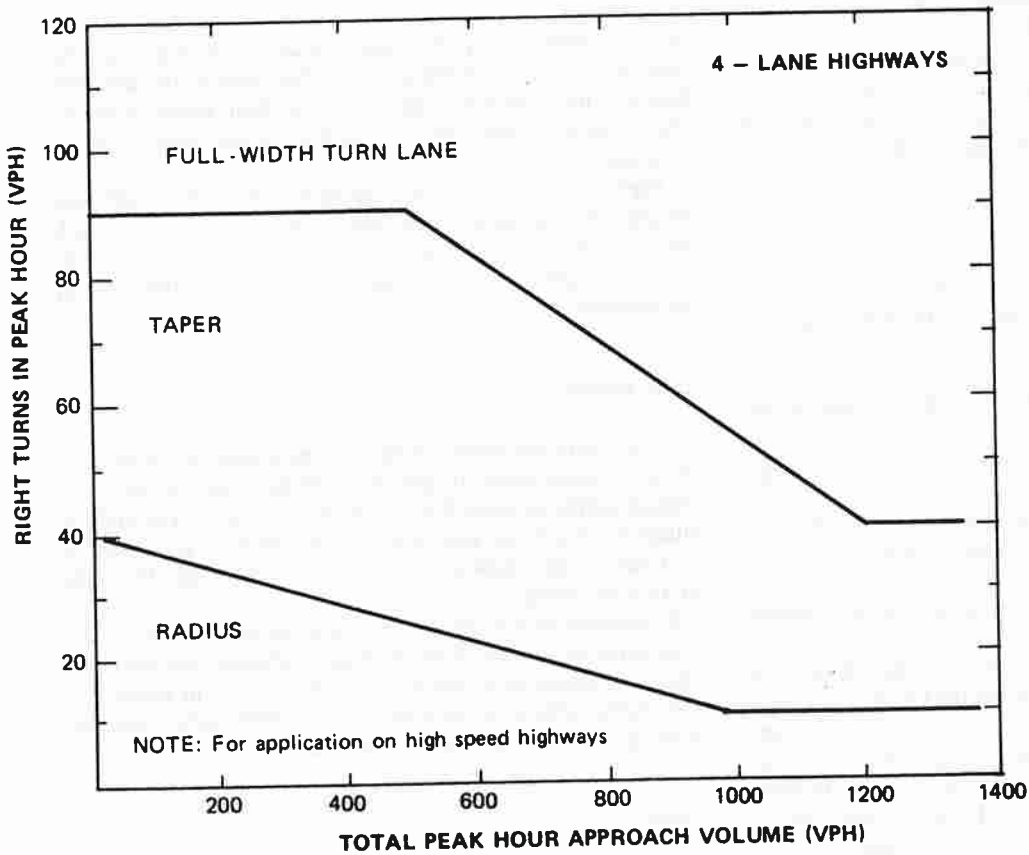
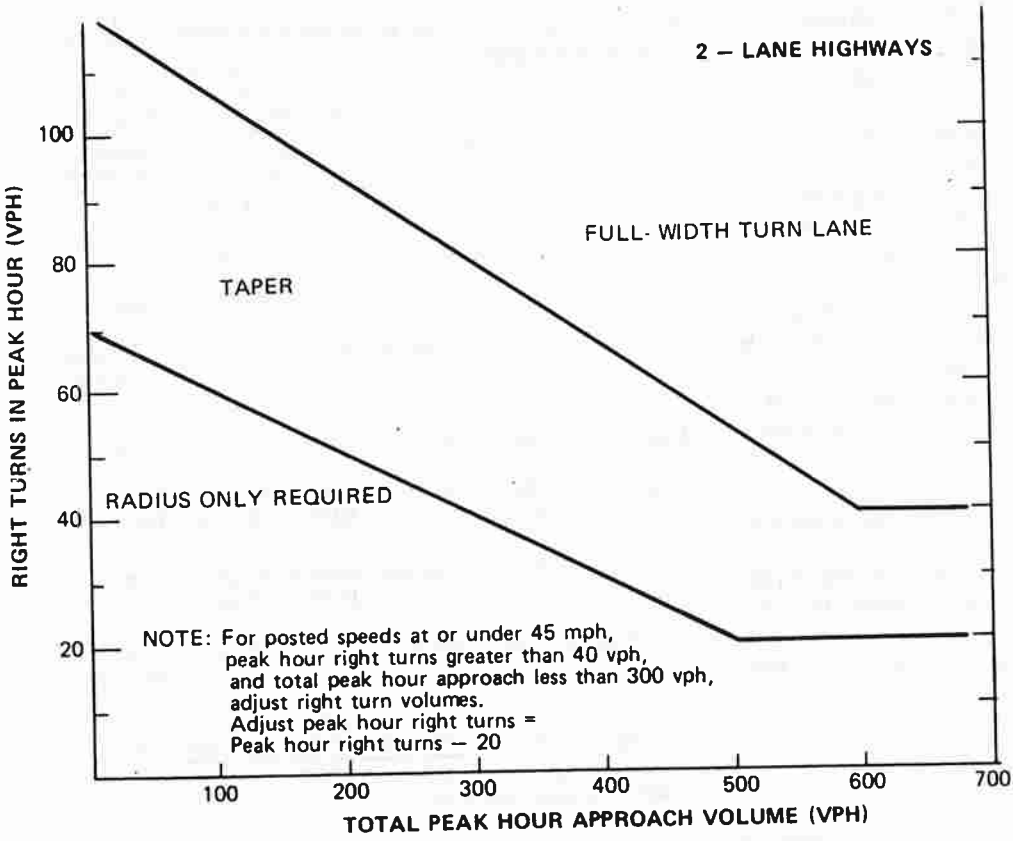

Figure 4-23. Traffic volume guidelines for design of right-turn lanes. (Source: Ref. 4-11)

$L_d/b$  -- Length of Taper and Lane For Deceleration and Braking

Functional Basis: To provide sufficient length for a vehicle to decelerate and brake entirely outside the through traffic lanes.

Desirable Design: Deceleration in gear for 3 seconds (occurs over bay taper) followed by comfortable braking to a stopped position or to the design speed of the corner radius.

Design Values For  $L_d/b$

For Design Speed of Corner Radius (mph)

Highway Design speed, V (mph)	Stop Condition*	15	20	25	30
30	235	185	160	140	-
40	315	295	265	235	185
50	435	405	385	355	315
60	530	500	490	460	430
65	570	540	530	490	480
70	615	590	570	550	510

\*Appropriate for right turn lanes on approaches to stop signs and traffic signals.

$L_s$  -- Length of Lane For Storage (Full Width Lane)

Functional Basis: To provide sufficient length for a reasonable number of vehicles to queue within the lane without affecting other lanes.

Desirable Design: Based on twice the mean arrival rate (per cycle for signals, per 2-minute period for stop control) during the peak hour of traffic.

Minimum Design: Based on mean arrival rate, with minimum storage for one vehicle.

$L_s$  for Stop Control

DHV (vph)	$L_s$ (ft)
<60	50-75
61-120	100
121-180	150
>180	200 or more

$L_s$  for Traffic Signal Control

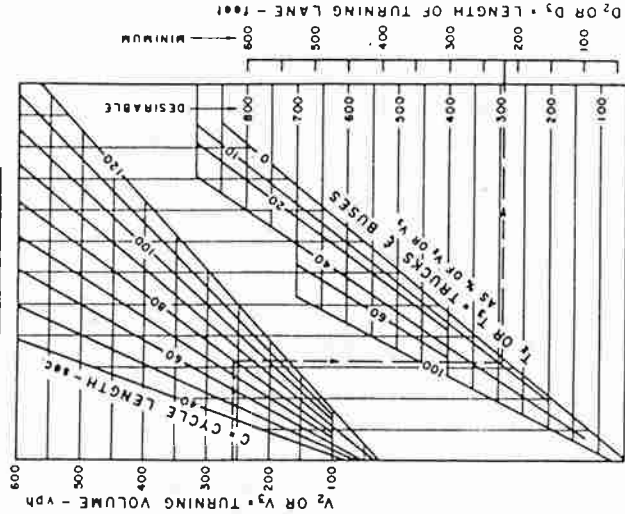

Figure 4-24. Guidelines for design lengths of right-turn lanes.

## CORNER RADIUS DESIGN

The corner radii are important design elements in that they influence the operational characteristics, construction cost, and maintenance of the intersection. Design for right corner radii entails more than consideration of turning and tracking requirements for right turning vehicles. Additional factors include: (1) presence of pedestrians and bicyclists, (2) other intersection geometry such as grades and curvature, or traffic islands, (3) desired traffic control, and (4) available right-of-way.

In all cases, the corner radius should be consistent with the other intersection features. Intersections on high speed highways with smooth alinement should be designed with sufficient radii to accommodate moderate to high speed turns. At other intersections, such as in residential neighborhoods, low speed turns are desirable. Smaller corner radii would be appropriate in these cases.

The safety effectiveness of various radii designs is difficult to establish directly. However, previous research (4-12) has noted a relationship between vehicle speed differentials and frequency of rear-end and angle collisions. Also, other research indicates that accident frequency along a corridor is partially a function of the number of access points per mile. Access points represent potential destinations requiring deceleration of turning drivers. Clearly, the speed at which right turning vehicles complete a turn, relative to the highway speed, is important in achieving a safe intersection.

An additional safety concern involves conflicts between vehicles and pedestrians. Both vehicle speed and open pavement area (representing pedestrian crossing exposure to vehicles) increase as corner radius increases.

### Design Guidelines—New Construction

Selection of appropriate corner radii should be based on the following factors:

1. The appropriate design vehicle.
2. The desired turning characteristic (i.e., speed and ease of turn, lane placement).
3. Other geometric elements such as angle of intersection, curvature, grades, and cross section.
4. Other intersection activities (primarily pedestrians).
5. Constraints, such as availability of right-of-way.

### Design Vehicle

Selection of an appropriate design vehicle is generally based on the largest standard or typical vehicle type that would regularly use the intersection. Where reliable vehicle classification counts are available, they can be used to select a design vehicle. More often, selection is based on the area type and functional classification of the intersecting highways. Table 4-8 summarizes recommended design vehicles for the range of intersection types.

Many agencies are designing intersections along their primary systems to accommodate a 70-ft, single trailer design vehicle. Figure 4-25 shows the turning characteristics of this C-70 design vehicle. Design for such vehicles entails provision for their minimum turns without encroachment on curbs, edges of pavement, or conflicting traffic lanes.

Table 4-8. Guidelines for selection of design vehicle.

HIGHWAY TYPE	DESIGN VEHICLE
<i>Rural Highways</i>	
Interstate/freeway ramp terminals	WB-50*
Primary arterials	WB-50*
Minor arterials	WB-50 or WB-40
Collectors	SU-30
Local streets	SU-30
<i>Urban Streets</i>	
Freeway ramp terminals	WB-50*
Primary arterials	WB-50 or WB-40
Minor arterials	WB-40 or B-40
Collectors	B-40 or SU-30
Residential/local streets	SU-30 or P

\* Consideration of larger design vehicles, such as WB-65, and other "over-size" vehicles is important. See Figure 4-25.

At certain locations, more than one design vehicle may be appropriate. Particular turning movements (say, for transit buses) may apply only to selected quadrants. Thus, some portions of an intersection may be designed with one design vehicle and other portions with a different design vehicle. In addition, it may be desirable to design the physical characteristics (curbs, islands) of intersection for one vehicle, but provide painted channelization for a smaller vehicle. This practice can reduce the visual effects created by spatial requirements for the infrequent large trucks.

Other considerations affecting selection of the design vehicle include adjacent land use (such as industrial parks) and presence of, or plans for, transit routes.

### Turning Characteristics

The designer should also consider the type or ease of turn to be accomplished by the design vehicle. Minimum or crawl speed turns are associated with the minimum turning characteristics of the design vehicles shown in Figure 2-2. Where it is desirable for vehicles to turn at a higher speed (i.e., for high volume turns or turns off high-speed streets), larger radii may be appropriate. Table 4-9 summarizes the operational characteristics of various corner radii for the range of design vehicles.

Table 4-9. Operational characteristics of corner radii.\*

CORNER RADIUS (FT)	OPERATIONAL CHARACTERISTICS
< 5	Not appropriate for even P design vehicles
10	Crawl speed turn for P vehicles
20-30	Low speed turn for P vehicles, crawl speed turn for SU vehicle with minor lane encroachment
40	Moderate speed turn for P vehicle, low speed turn for SU vehicle, crawl speed turn for WB-40 or WB-50 vehicle with minor encroachment
50	Moderate speed turns for all vehicles up to WB-50

\* Assuming approach and departure occurs in curb lane.



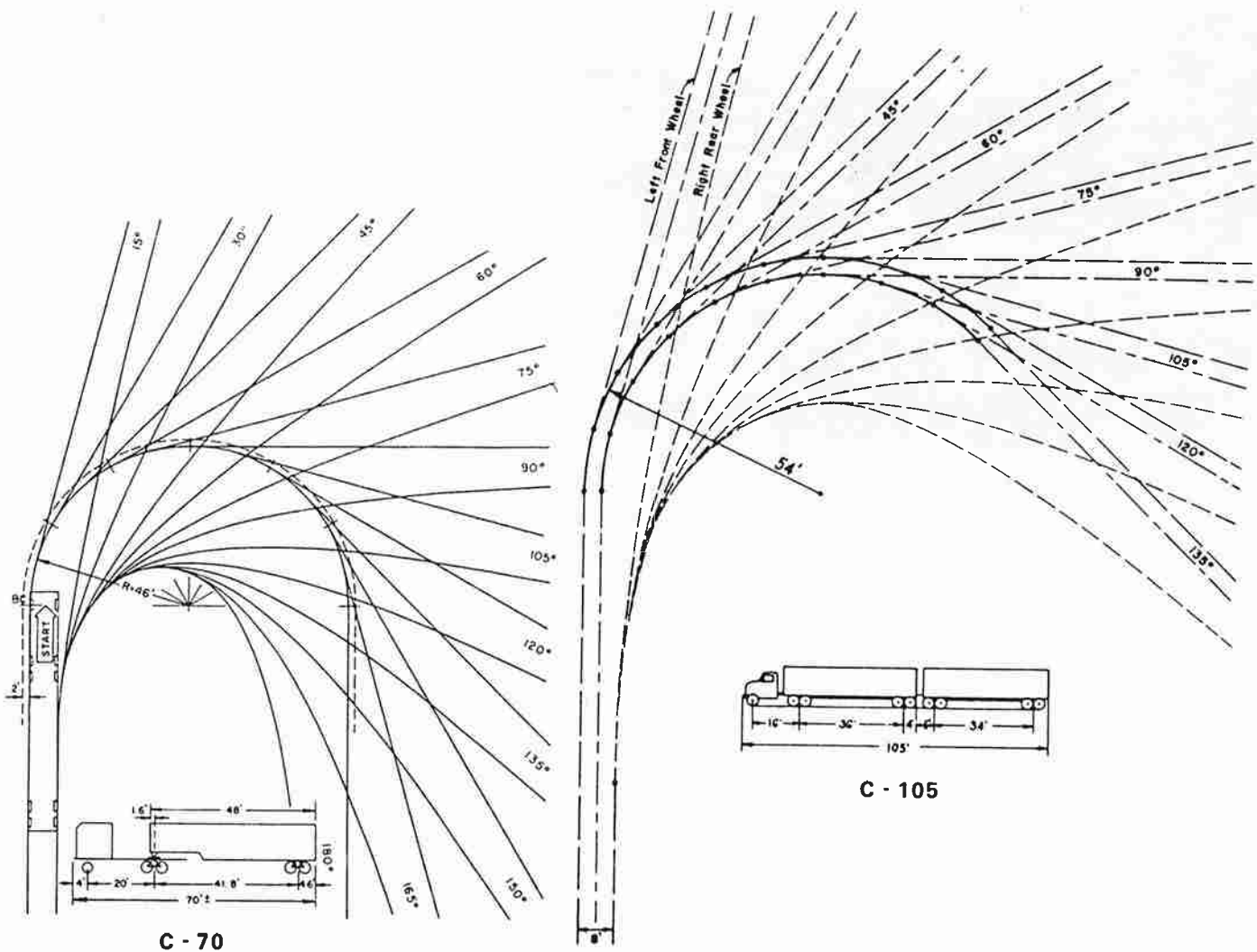

Figure 4-25. Special design vehicles for intersection.

Wherever possible, the design of the corner radius and right-turn lanes or tapers should be consistent with respect to "design" or assumed turning speeds. (See guidelines on design of right-turn lanes.)

#### Other Geometric Elements

Where the turning movement itself is influenced by other features, the radius design should be coordinated with the controlling geometry. Adverse horizontal curvature, making a turning movement more difficult, can be partially mitigated by slightly greater radius design. Heavy skew angles generally require greater corner radii than 90-degree turns.

On narrow streets, or 2-lane streets with bus or large truck design vehicles, radii should be increased to avoid encroachment of the design vehicle on opposing lanes. On wider streets, it may be appropriate to assume encroachment on adjacent, same direction lanes for turning design vehicles. This can greatly decrease the required corner radius, while not measurably downgrading operations for most vehicles.

#### Pedestrian Considerations

On many urban streets, pedestrians may be as important a consideration as right turning vehicles. Smaller corner radii, typically no greater than 30 ft, can decrease right turn speeds and reduce open pavement area for pedestrians crossing the street. Both features contribute to the safe handling of vehicle/pedestrian conflicts. See Figure 4-26.

#### Curb Cuts and Ramps For Handicapped

Most public works agencies require provision for handicapped ramps in new or reconstructed intersections. Their presence, usually at the corner radius, is necessary to provide access across the intersection to *all* potential users. The following guidelines have been suggested (4-13) for the location and design of ramps for handicapped:

1. Matching curb ramps should be provided at all intersection quadrants to provide maximum accessibility.

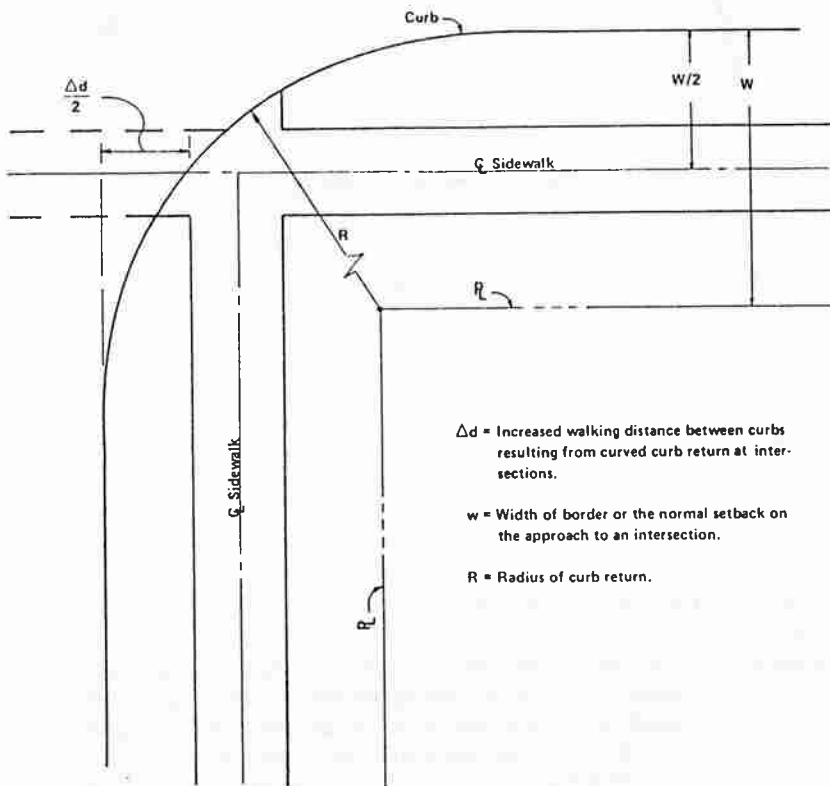
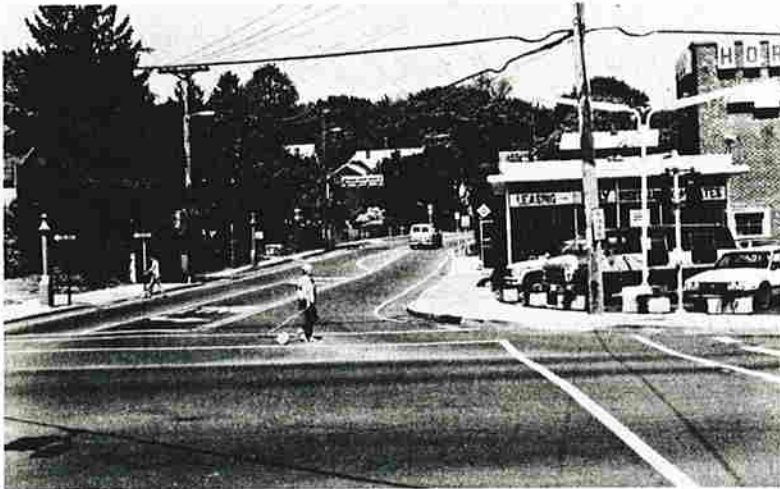

Curb Radius, R Feet	Added Crosswalk Distance $\Delta d$	
	W = 10' Feet	W = 20' Feet
10	3	0
20	14	5
30	27	15
40	42	27
50	57	40

Figure 4-26. Effect of curb radius on pedestrian crossing distances. (Source: Ref. 4-10)

2. Utilities, drainage inlets, signs and other fixed objects should not be located within the path defined by the curb ramp.

3. Curb ramps should only be constructed where sidewalks are provided.

4. Location of curb ramps relative to cross walks and corner radii should follow the guidelines illustrated in Figure 4-27.

5. Maintenance of curb ramps is important. Accumulation of debris tends to occur at the base of the ramp. Also, care should be taken to ensure that the bottom of the ramp is not affected should the street be repaved.

Figure 4-28 illustrates ramp design treatments.

### Design Alternatives to Simple Radii

Where right-of-way is extremely limited, corner radii may have to be reduced. An alternative to small radii is multicentered curvature or simple curvature with offsets from one or both edges of pavement.

Multicentered curves (including two-centered, three-centered symmetrical or three-centered asymmetrical) and simple radii curves with tangent offsets are useful design alternatives. The AASHTO policy (4-10) discusses multicentered curve radii designs with their operationally equivalent simple radius designs.

Because of their space efficiency, there are significant benefits to multicentered curvature regardless of right-of-way or space constraint. These benefits include reduced open pavement area (thereby resulting in lower pavement and drainage costs) and reduced need for right-of-way. In addition, properly designed multicentered curves are consistent with the basic channelization principle of clearly defining vehicular paths.

Despite these benefits, some agencies do not regularly use multicentered curvature. The reasons cited generally include "difficulty in calculation" or "difficulty in field stake-out or construction." The use of standard designs is recommended where such problems are anticipated.

### DESIGN OF TURNING ROADWAYS

Turning roadways are created by high-type right-turn radius designs and corner traffic islands. They are typically used at high-speed and/or high-volume intersections, and are associated with a high level of service for right-turning vehicles.

It is important to provide a turning roadway design that is consistent with the speed and volume characteristics of the turn. The primary design elements comprising turning roadways are (1) radius of turn, (2) development of superelevation, and (3) width of roadway.

#### Radius of Turn

The design for a multicentered radius dictates the need for, or desirability of a separate turning roadway. (See "Design Alternatives to Simple Radii" regarding selection of appropriate radii.) Application of appropriate design criteria for islands results in minimum radii of 60 to 100 ft, or their equivalent multicentered curves, associated with minimum sized corner islands.

### Development of Superelevation

Turning roadways require superelevation to assist drivers in completing the turn with relative comfort at the design speed of turn. With urban intersections designed with curb and gutter, superelevation may also be important in providing for drainage to the outside edge of pavement. Design for superelevation should consider grades of approach and departure roadways, desired maximum superelevation, and reasonable rates of change of superelevation. These controls are summarized in Figure 4-29.

### Width of Roadways

The width of turning roadway is critical in determining its operation. Widths should be based on the turning path of the design vehicle and any additional space to handle unusual occurrences, such as vehicle stalls within the roadway. This is an important consideration because the presence of the corner island limits the ability of vehicles to bypass stalled or parked vehicles on the roadway. Figure 4-29 summarizes the range of controls typically used to determine turning roadway widths.

### TRAFFIC ISLANDS

Traffic islands are among the basic tools for achieving channelization objectives. As Figure 4-30 illustrates, islands are applicable to a number of situations.

Design of traffic islands must consider their intended site-specific functions. These may include definition of vehicle paths, separation of traffic movements, prohibition of movements, protection of pedestrians, placement of traffic control devices, or a combination of these. Application of design guidelines and standards to reflect these functions involves the following considerations:

1. Selection of an appropriate island type (raised or barrier type, mountable, painted or flush).
2. Determination of the proper size and shape of islands.
3. Location of the island relative to adjacent traffic lanes or crosswalks.
4. Design of the individual elements of the island itself.

As with other channelization elements, the above considerations are affected by traffic characteristics, such as volume and speeds, and environmental factors.

It is difficult to attribute safety effects to the installation of traffic islands per se. Most accident research has focused on specific elements such as left-turn or right-turn lanes.

One set of studies investigated differences in accident experience associated with raised vs. painted channelization. The findings, summarized in Figure 4-31, demonstrate the following:

1. The use of traffic islands can, in general, contribute to lower accident severities.
2. Raised traffic islands are more effective than painted islands in reducing frequencies of night accidents, particularly in urban areas.
3. Little difference is noted in the effectiveness of raised vs. painted channelizing islands at rural intersections.

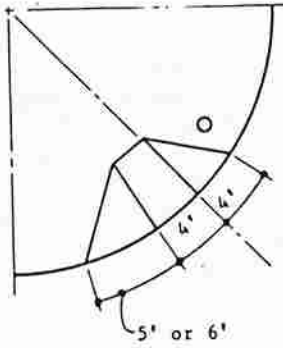

a. If the obstruction is located 0'-6' from the middle of the curb return, offset the ramp in the direction of the major pedestrian movement.

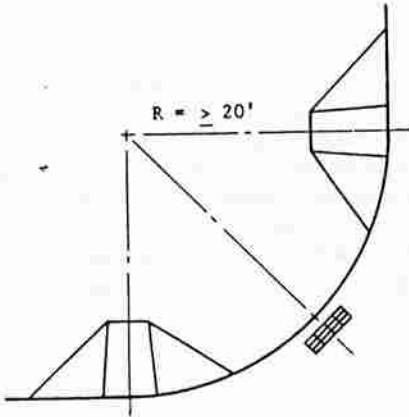

b. If a drop inlet is located 0'-6' from the middle of the curb return with a radius greater than or equal 20', parallel curb ramps should be installed. Parking should be restricted at least 10 ft. (20 ft. preferred) from the curb ramps.

If the curb radius is less than 20', the ramp should be offset in the direction of the major pedestrian movement as in part of this figure.

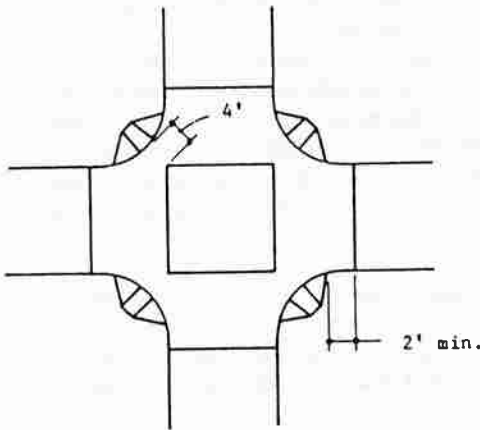

a. Middle of curb return (or diagonal) curb ramps.

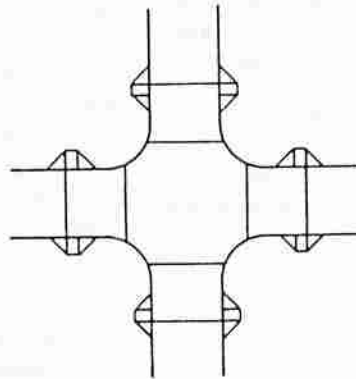

b. Parallel curb ramps.

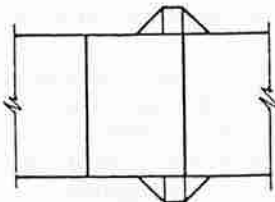

c. Parallel curb ramps located within crosswalks greater than or equal to 12 ft. in width.

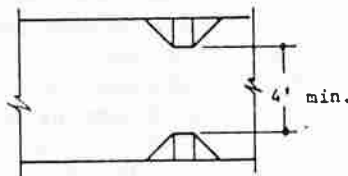

Parallel curb ramps in a median. Medians may be made accessible by providing a break in the median or a crosswalk in front of the median.

For crosswalks or medians less than 12 ft. wide, center the ramp in the walk or median.

Parking should be restricted within 10 ft. (20 ft. preferred) of the curb ramp.

Figure 4-27. Guidelines for location and design of curb ramps for the handicapped. (Source: Ref. 4-13)

CURB RAMP PLACEMENT

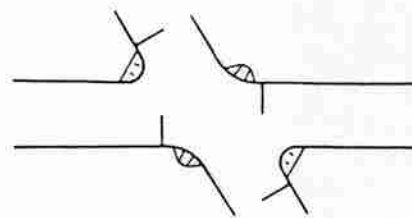

— Curb ramp dimensions may require that the corner be rounded off (4-ft. wide ramp required).

a. Oblique angle intersections.

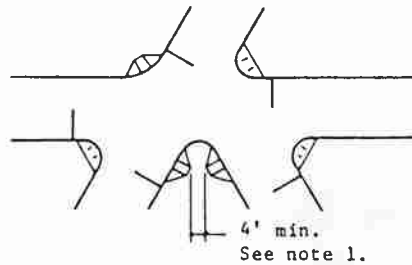

Note 1. If the spacing between ramps is less than 4', then curb height should be reduced or ramp slope increased to maximum of 10:1. This is similar to a median (Figure 7c).

b. Multi-leg intersections.

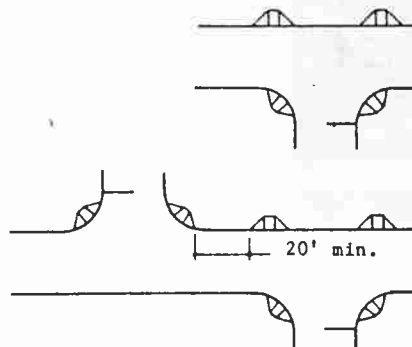

T intersection

At least one parallel curb ramp should be installed. If one parallel curb ramp is used, then it should be located in the path of the lightest turning movements from the cross street.

Jogged intersection

(The above note is applicable.)

c. T and jogged intersections.

CURB RAMPS FOR VARIOUS RADII

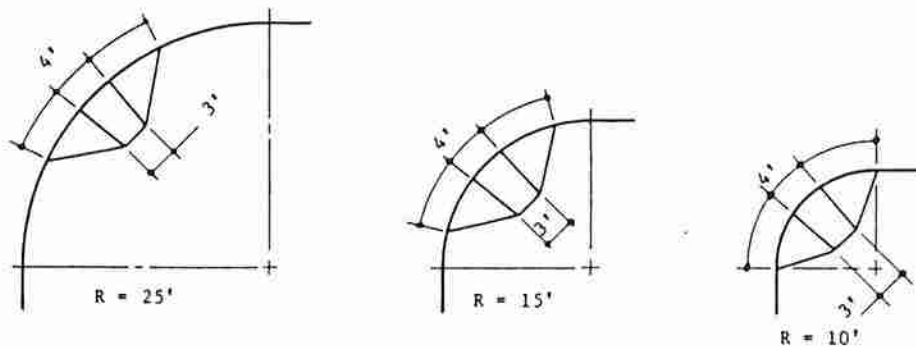

Figure 4-27. Continued



*Offset ramp on wide crosswalk.*



*Centered ramp on small radius curb return. Note the placement of the traffic signal and controller, which provide a clear area for pedestrians and wheelchairs.*

*Figure 4-28. Examples of curb ramp design.*

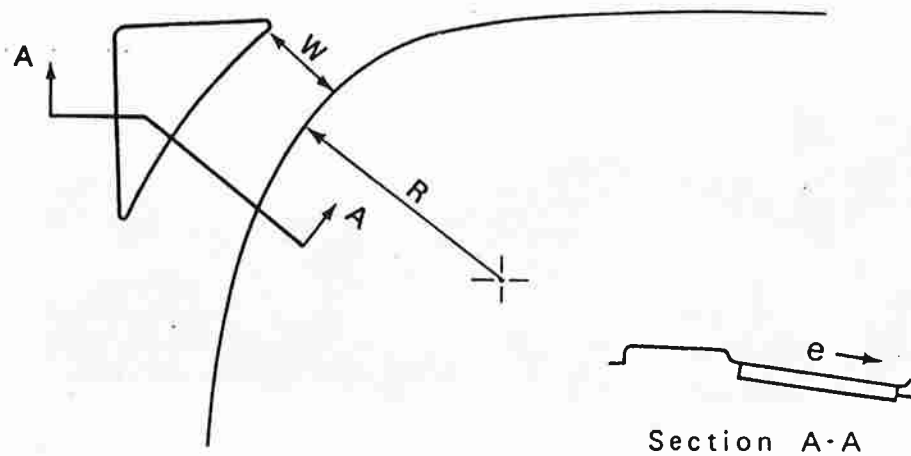

### W --- WIDTHS OF TURNING ROADWAYS

Radius on Inner Edge of Pavement, R (ft)	Case I One-Lane, One-Way Operation, No Provision for Passing a Stalled Vehicle				Case II One-Lane, One-Way Operation, With Provision for Passing a Stalled Vehicle by Another of the Same Type				Case III Two-Lane Operation, Either One- or Two-Way (Same Type Vehicle in Both Lanes)			
	Pavement Width (ft) for Design Vehicle:											
	P	SU	WB-40	WB-50	P	SU	WB-40	WB-50	P	SU	WB-40	WB-50
50	13	18	23	26	20	29	36	44	26	35	42	50
75	13	17	19	22	19	27	31	36	25	33	37	42
100	13	16	18	21	19	25	29	34	25	31	35	40
150	12	16	17	19	18	24	27	29	24	30	33	35
200	12	16	16	17	18	23	25	27	24	29	31	33
300	12	15	16	17	18	22	24	25	24	28	30	31
400	12	15	16	16	17	22	23	24	23	28	29	30
500	12	15	15	16	17	22	23	24	23	28	29	30
Tangent	12	15	15	15	17	21	21	21	23	27	27	27

NOTE: P = passenger vehicles; SU = single-unit trucks; WB-40 = semitrailer combinations; WB-50 = semitrailer combinations.

R Radius (ft)	Degree of Curve	Range in Superelevation Rate — e for Intersection Curves with Design Speed (mph) of					
		15	20	25	30	35	40
50	—	.02-.10	—	—	—	—	—
90	63.6	.02-.07	.02-.10	—	—	—	—
150	38.2	.02-.05	.02-.08	.04-.10	—	—	—
230	24.8	.02-.04	.02-.06	.03-.08	.06-.10	—	—
310	18.5	.02-.03	.02-.04	.03-.06	.05-.09	.08-.10	—
430	13.3	.02-.03	.02-.03	.03-.05	.04-.07	.06-.09	.09-.10
600	9.6	.02	.02-.03	.02-.04	.03-.05	.05-.07	.07-.09
1,000	5.7	.02	.02-.03	.02-.03	.03-.04	.04-.05	.05-.06
1,500	3.8	.02	.02	.02	.02-.03	.03-.04	.04-.05
2,000	2.9	.02	.02	.02	.02	.02-.03	.03-.04
3,000	1.9	.02	.02	.02	.02	.02	.02-.03

NOTE: Preferably use superelevation rate in upper half or third of indicated range. In areas where snow or ice is frequent, use maximum rate of 0.06 or 0.08.

Figure 4-29. Design controls for turning roadways. (Source: Ref. 4-10)

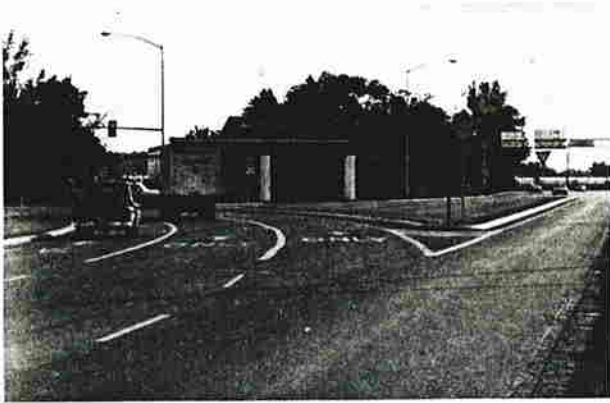

Traffic islands separate movements and define vehicle paths.



Islands also protect turning or queued traffic.



Note the offset of the center island. Islands can be used to prohibit unsafe or undesirable movements.



Traffic islands physically separate opposing traffic flows.

Figure 4-30. Illustrative functions of traffic islands.

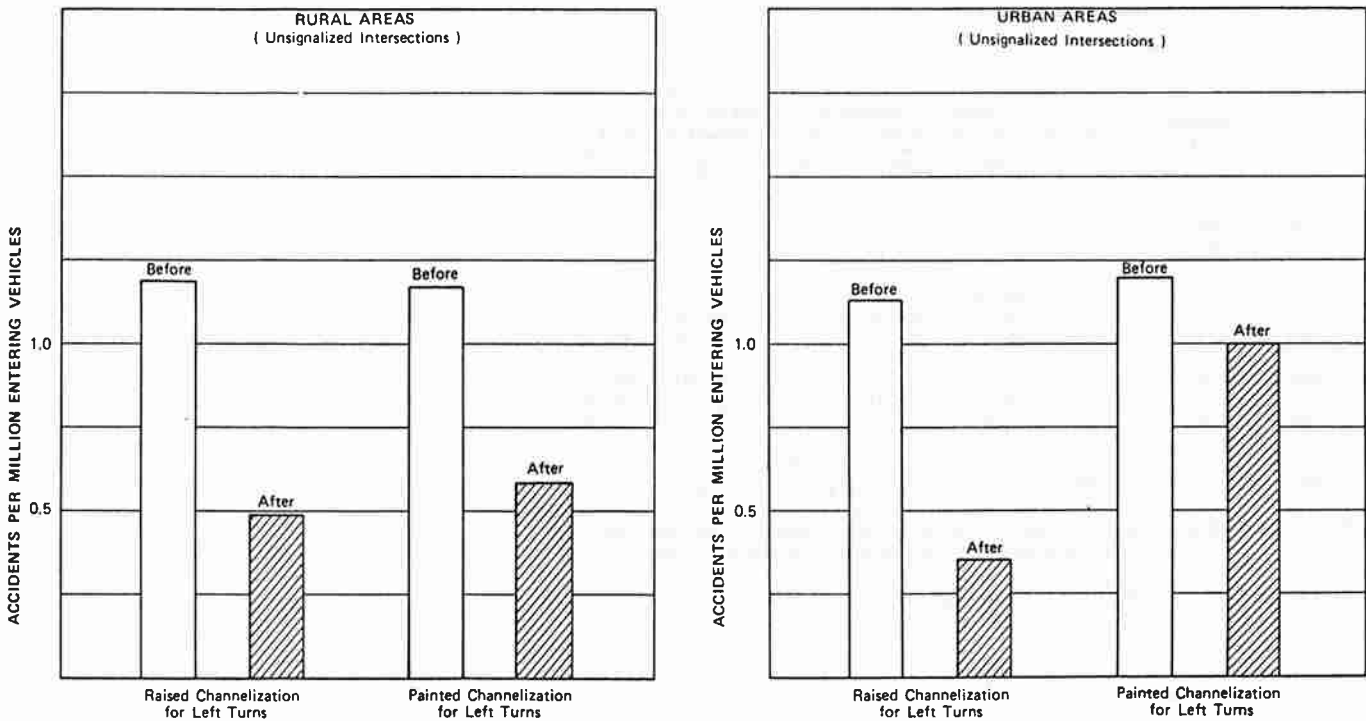

Figure 4-31. Safety effectiveness of painted and raised channelization. (Source: Ref. 4-14)



Current practice among traffic and design engineers is generally consistent with the safety effectiveness research. Table 4-10 summarizes the opinions of engineers on their preferences regarding the use of different types of traffic islands.

There is clearly a preference for raised channelization where positive delineation or protection is desirable, and where the risk of high speed impacts with curbs is minimal. Conversely, at high speed, lower volume intersections, typical of rural locations, painted or flush traffic islands are generally preferred.

#### Guidelines for Selection of Island Type

Selection of an appropriate type of traffic island should be based on traffic characteristics, cost considerations, and maintenance needs. Painted (thermoplastic) or flush channelization is appropriate:

1. On high-speed rural highways to delineate separate turning lanes.
2. In constrained locations where vehicle path definition is desired, but space for larger, raised islands is not available.

Flush channelization is not effective in prohibiting or preventing traffic movements, nor is it appropriate for islands intended to serve as locations of pedestrian refuge.

Flush traffic islands may also be used:

1. To separate opposing traffic streams on low speed streets.
2. In lieu of raised channelization in regions of frequent snow-fall requiring removal.
3. As temporary channelization either during construction or to test traffic operations prior to installation of raised islands.

Raised traffic islands (i.e., those designed with mountable or semimountable curbs) are necessary:

1. Where the primary function of the island is to shield pedestrians from vehicular traffic.
2. Where a primary or secondary island function is the locating of traffic signals, signs, or other fixed objects.
3. Where the island is intended to prohibit or prevent traffic movements.

Raised islands may also be appropriate under other circumstances:

1. On low to moderate speed highways where the primary function is to separate high volume opposing traffic flows.
2. At locations requiring more positive delineation of vehicle paths, such as at major route turns or intersections with unusual geometry.

Actual design of islands is described in the following sections.

#### Guidelines for Design of Traffic Islands

Good design of traffic islands takes into account a number of factors:

**Table 4-10. Summary of comments regarding the use of traffic islands (from survey of engineers and designers).**

CHANNELIZATION FUNCTION SPECIFIED AS REQUIRING PAINTED CHANNELIZATION <sup>a</sup>	TYPICAL OPERATING CONDITIONS <sup>a</sup>
• For right turns (4)	• High speeds (7)
• To provide temporary or trail channelization (3)	• Rural highway (5)
• To shadow left turns (1)	• Minor urban intersections (2)
CHANNELIZATION FUNCTION SPECIFIED AS REQUIRING RAISED CHANNELIZATION	TYPICAL OPERATING CONDITIONS
• Post signs or signals (13)	• Urban streets (4)
• Provide pedestrian refuge (7)	• Low speeds (4)
• Prevent or enforce wrongway movements (7)	• High volumes (3)
• Provide local access control (5)	• Major arterials (2)
• Provide positive separation of movements (5)	
• Provide positive delineation (3)	

<sup>a</sup> Number in parentheses represents number of survey responses.

1. Design speeds of intersecting highways and turning roadways.
2. Cross section of intersecting highways.
3. Type of island to be used.
4. Approximate size of island to be used.

Above all, the island's design should ensure fulfillment of its design objectives. Islands intended to define or delineate turning roadways should not be placed in a manner that inhibits vehicular movement. Islands to be used as pedestrian refuge should not be too small. Adherence to the following principles of design will maximize the quality and efficiency of the intersection:

1. The proper traffic lanes or turning roadways should appear natural and convenient to their intended users.
2. The number of islands should be held to a practical minimum to avoid confusion.
3. Islands should be large enough to be effective. Small islands do not function as channelizing devices and tend to present maintenance problems.
4. Islands should not be introduced at locations with restricted sight distance or in the middle of sharp horizontal curves.

Consideration of appropriate traffic control is important in design of corner traffic islands. In such instances, creation of a separate turning roadway requires a separate traffic control device (STOP or YIELD sign, or traffic signal head) or operation as a free right turn.

Recommended design values for traffic islands are summarized in Figure 4-32. Values for traffic island size, nose and merging end dimensions, and island offsets are consistent with current design practice nationwide. Figure 4-33 illustrates the application of design principles for corner islands.

**Guidelines For Design of Median Islands**

Design of median islands generally reflects site-specific geometrics such as angle of intersection and cross section. The following guidelines address good design of median approach islands.

1. Approach noses should be offset 2 to 6 ft from the through (approach) lanes to minimize accidental impacts. Pavement markings in advance of the nose can be used to transition from the centerline to the edge of island.
2. The shape of the island should be based on design turning paths and the island function. Curvilinear tapers comprised of parabolic or circular curves generally suffice.
3. The length of the island should be related to the approach speed. Some agencies recommend a length based on 3-sec driving time to the intersection. Of course, the island length will be affected by available widths, taper designs, and local constraints.
4. The width of the island should adequately serve its intended functions. These may vary from access control or separation of conflict to pedestrian refuge, to shielding of left-turn lanes.
5. Median islands should begin on tangent alignment, and on upgrades or well past crest vertical curves. In some cases it is appropriate to extend a median island to avoid its introduction on a horizontal curve or within an area of limiting sight distance.

Figures 4-34 and 4-35 illustrate median island design guidelines and criteria.

Design of medians must reflect their intended functions. Table 4-11 discusses median functions and appropriate widths.



*This triangular island is too small to serve any channelization function.*



*This island is large enough to effectively function as a channelizing island for right turns, a location for pedestrians (note the handicapped ramps) and a location for the traffic signal.*

**Recommended Island Sizes**

Location of Intersection	Size (Sq. Ft.)	
	Minimum	Desirable Min.
Urban	50*	75
Rural and High Speed Urban/Suburban	75	100

*Figure 4-32. Guidelines for location and design of traffic islands.*

**Table 4-11. Basic median functions and their required width.**

FUNCTION	WIDTH IN FEET	
	MINIMUM	DESIRABLE
Separation of opposing traffic	4	10
Provision for pedestrian refuge	6	14
Provision for storage of left-turning vehicles	16	20
Provision for protection of vehicles crossing through lanes	25	30
Provision for U-turns, inside to outside lanes	16	20
Provision for U-turns, inside to inside lanes	26	30

SOURCE: Ref. 4-15

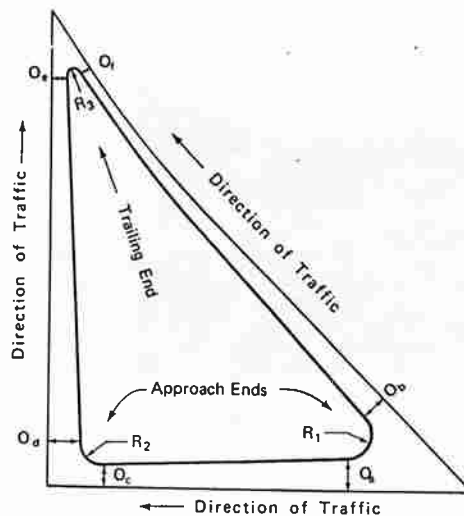

Recommended Offset Dimensions For  
Location of Traffic Islands

Offset in Feet (See Figure Above )

$O_a$	$O_b$	$O_c$	$O_d$	$O_e$	$O_f$
2'-6'	1'-3'	2'-3'	2'-6'	2'-3'	0'-1'

Note: Offset values at the high end of the range are appropriate for high speed roadways and large islands.

For roadways with shoulders the island should be offset from the outside edge of shoulder.

Recommended End Radius Dimensions  
For Design of Traffic Islands

Radii in Feet (See Figure Above )

$R_1$	$R_2$	$R_3$
2'-3'	2'-5'	1'-2'

Note: Offset values at the high end of the range are appropriate for high speed roadways and large islands.

Figure 4-32. Continued

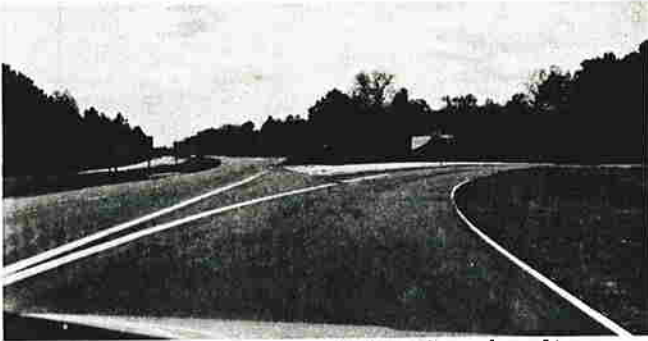

*A full offset and blunt approach end radius are appropriate for traffic islands at high-speed right turn lanes.*

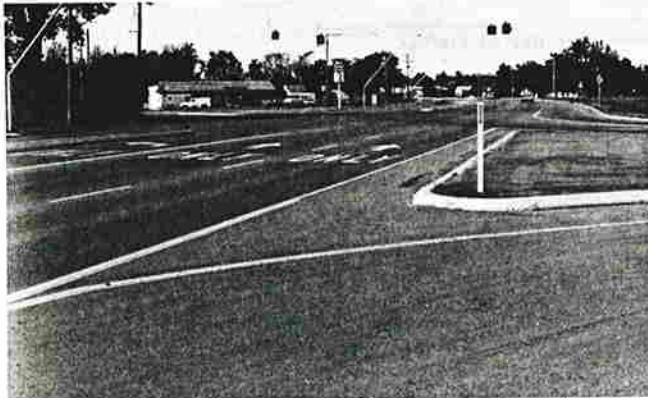

*Good offsets on this approach end promote safe operation of the high speed turning roadway.*



*Note the continuous tapering effect created by careful placement of both corner islands.*

*Figure 4-33. Example corner island designs.*

## ACCESS CONTROL AND DESIGN OF DRIVEWAYS

Traffic movements associated with land uses adjacent to intersections can significantly affect their operations. Congestion, delay, and accidents caused by vehicles accessing commercial properties are major problems in most urban areas. Consideration of access requirements and their effects is therefore necessary in design of most urban and suburban intersections.

The problem is basically in assessing and handling trade-offs between the need to provide access to businesses and residences and the need to maintain at least a minimally acceptable level of service during peak periods. This problem is greatest along fringe urban and suburban arterials with rapidly developing land uses. Corridor demands for relatively high speeds and capacity directly conflict with demands for frequent access.

Access design and control is addressed here in two specific areas: (1) channelization techniques to restrict or control access, thereby mitigating its adverse effects; and (2) appropriate design of driveway access. In both areas, the following considerations affect the application and design standards and guidelines: land use, traffic volumes, turning traffic, cross section, and prevailing speeds.

Many authors have studied the safety impacts of both isolated and frequent driveways on corridors and intersections. Accident problems include rear-end and merging conflicts associated with right turns, and left-turn angle accidents. Figure 4-36 illustrates the potential magnitude of the driveway accident problem, as well as the types of accidents that occur.

### Guidelines For Control of Access

There are a number of techniques available for accommodating frequent and/or high-volume access needs along corridors. The material in Table 4-12 summarizes various access control techniques and their warranting operational conditions. This material is taken from Ref. 4-19.

### Guidelines For Design of Driveways

Driveways should be varied as intersections in terms of the proper approach to design. The designer should be concerned with vehicle characteristics, such as turning radii and offtracking, and acceleration and deceleration.

Driveway operations can be characterized in the following manner:

- In the absence of a separate left-turn lane, the left-turn entry movement generally produces the greatest hazard and congestion.
- The left-turn exit movement is the most sensitive to spacing of the driveway relative to the nearest point of street traffic control (especially a signal). Such movements are also relatively hazardous.
- The right-turn entry into a driveway is the second most sensitive movement in respect to spacing from the location of street traffic control. Such movements also impede through traffic.

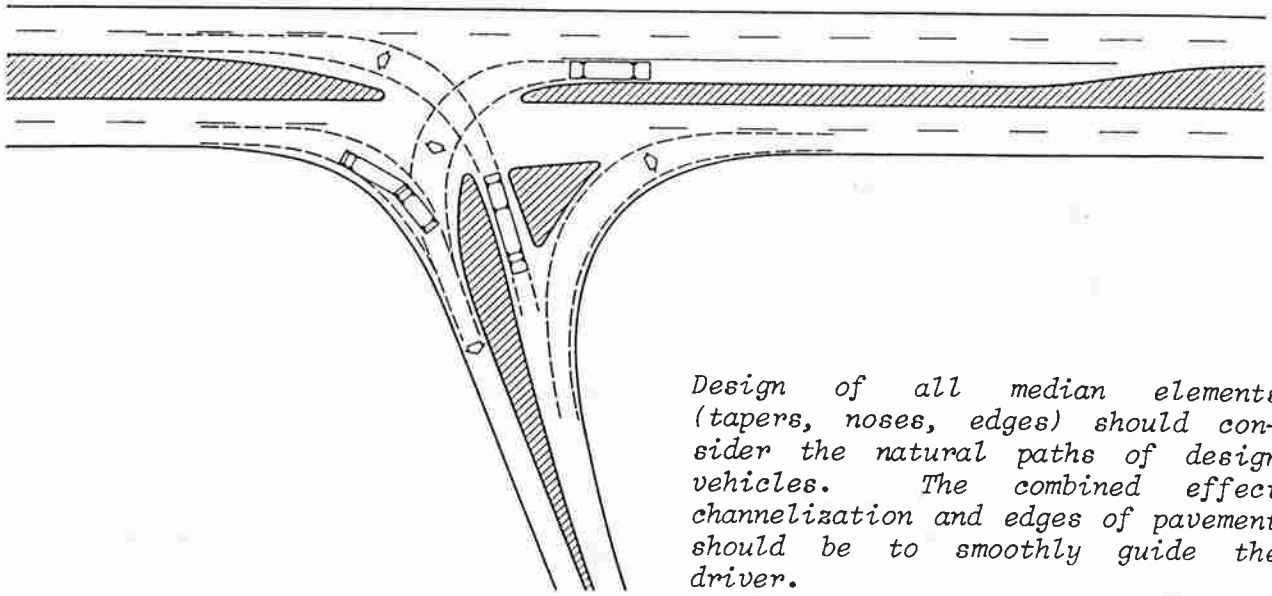

*Design of all median elements (tapers, noses, edges) should consider the natural paths of design vehicles. The combined effect channelization and edges of pavement should be to smoothly guide the driver.*



*The geometric elements of median islands should reflect natural paths of vehicles.*



*Tapers that are too short appear "stiff" and unnatural, and are not consistent with vehicle paths.*



*Approach noses to median islands should be offset from the traffic lanes.*

*Figure 4-34. Guidelines for design of median islands.*

## NOTE:

1. WIDTH OF ISLAND CONTROLLED BY NOSE PLACEMENT AS DETERMINED BY CONTROL RADII AND ANGLE OF INTERSECTION OR ADDED LEFT TURN LANE.
2. VERTICAL AND HORIZONTAL ALIGNMENT ON APPROACH TO PROVIDE MINIMUM STOPPING SIGHT DISTANCE.
3. CONTROL DIMENSION, W, SHOULD BE FROM EDGE TO EDGE OF PAVEMENT AND SHOULD NOT INCLUDE GUTTER

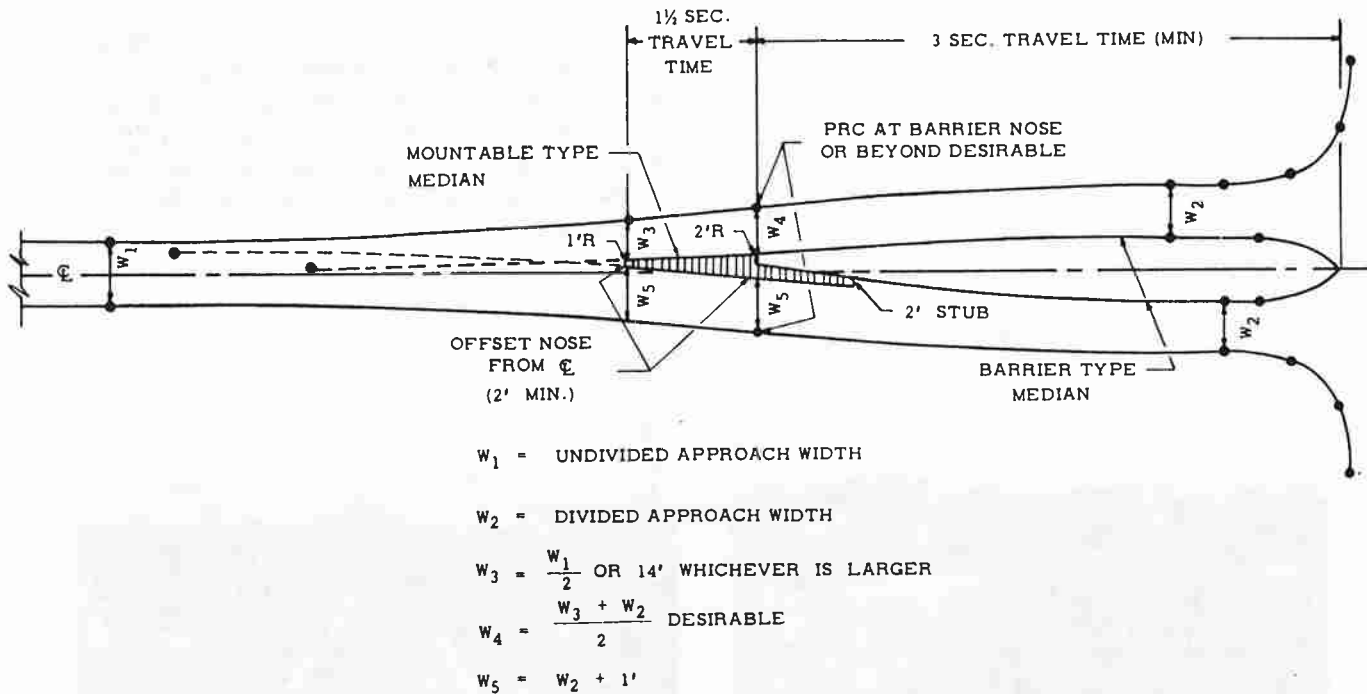

Figure 4-35. Design criteria for raised median approaches to intersections. (Source: Illinois Department of Transportation)

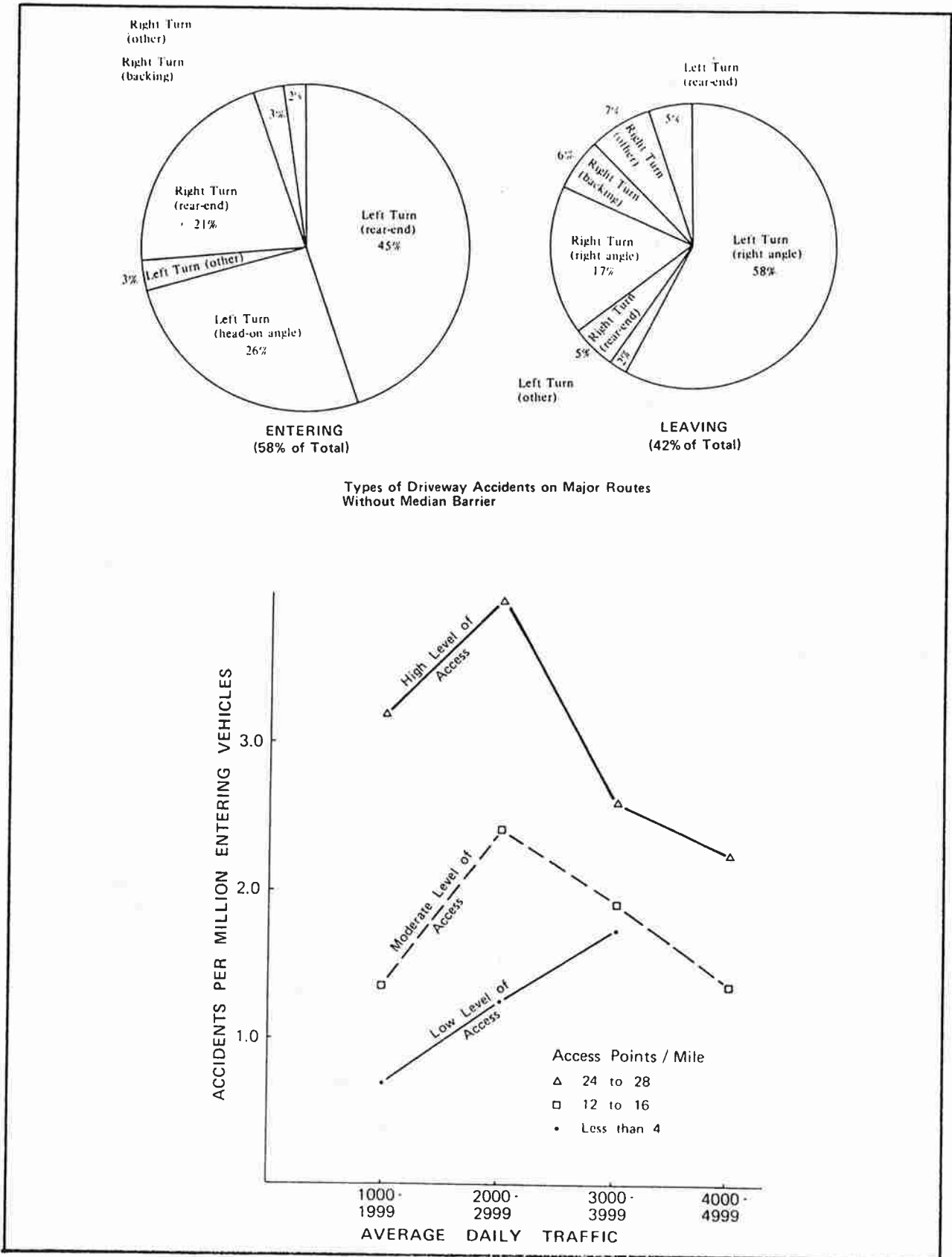

Figure 4-36. Driveway accident characteristics. (Source: Refs. 4-17 and 4-18, top figures; Ref. 4-16, bottom figure)

Table 4-12. Guidelines for application of access control techniques.

ACCESS CONTROL TECHNIQUE	HIGHWAY TYPE	SPEED (MPH)	AVERAGE DAILY TRAFFIC	NUMBER OF DRIVEWAYS PER MILE
Raised median to prohibit left turns	Multilane arterials	40+	10,000 vpd; peak-hour left turns 150+ /mile	30 to 60
Raised channelization to limit access to right-in and right-out	Multilane divided highways	30 to 45	5,000 vpd; prohibited turns less than 100 vpd per mile	30+
Raised median with left-turn lanes	Multilane highways	30 to 45	10,000 vpd; peak-hour left turns 150+ /mile	30+
Improved median opening geometry (tapers)	Multilane divided highways (4-ft medians as minimum)	30+	5,000 vpd	15+
Alternating left-turn lanes	All types with available width	35+	10,000 vpd; peak-hour left-turn demand at least 15% of through traffic	45+; 1000 ft + between major intersections
Conversion of two-way driveway to two one-way driveways	All types	35+	10,000 vpd; peak-hour left turn of 40 vph	1 to 60
Conversion of two-way driveway to two two-way driveways with restricted access movements	Divided highways	35+	10,000 vpd; peak-hour left turns of 40 vph	1 to 60
Construction of local service road with limited, controlled access points	Primary divided arterials	40 to 55	20,000 vph	60+
Physical barrier to prevent uncontrolled access to driveway	All types	All	10,000 vph; driveway volume 500 vpd	45+ Isolated locations
Widen narrow right lanes to assist right turns	Urban arterials	30+	5,000 vpd; right turn driveway volume of 100+ vph per mile in peak hour	20+
Installation of right turn deceleration lane	All	35+	10,000 vpd; driveway volume 1,000 vpd; right turn volume of 40 vph in peak hour	Isolated locations
Continuous right-turn lanes	All	30+	15,000 vpd; right turn volume per mile at least 20% of total	60+
Installation of right turn acceleration lane	All	35+	10,000 vpd; right turn egress of 75 vph in peak hour	Isolated locations

SOURCE: Adapted from Ref. 4-19



### Driveways Along Major Arterials or Collectors

Driveways along major arterials and collector routes should be designed for curb lane access and with minimal encroachment on travel lanes disregarding present parking practices. In order to preclude encroachment on travel lanes, radii for right turn entry and exit should be consistent with the design vehicle's swept path requirements. If the radius is inadequate, encroachment will occur unless the entering or leaving vehicle temporarily occupies a substantial width of the driveway throat. Figure 4-37 illustrates design for a high volume driveway off a major arterial.

### Consideration of Pedestrians

In most areas, pedestrian/vehicle conflicts in driveways are infrequent. However, where pedestrian safety is a concern (such as near schools or high pedestrian-generating land uses) it may be appropriate to design driveways with small radii and restricted widths. This not only reduces pedestrian time of exposure to accidents, but also decreases vehicle speeds.

### Driveways in Rural Areas

Driveways off higher speed rural highways should be designed to a higher level than urban driveways. The primary objective is to quickly remove slower, entering vehicles from through traffic streams.

Figures 4-38, 4-39, and 4-40 summarize design guidelines for driveways in rural and urban areas.

### FINALIZING THE DESIGN

An often overlooked, but nonetheless important aspect of design, is the overall appearance of the intersection. Alinement that is smooth and flowing not only is aesthetically pleasing, but also is consistent with the basic principles of channelization. It is always desirable to produce a design that closely fits natural vehicle paths. Thus, smooth tapers and transitions, corner radius designs, and island designs are essential to good design.

The production of smooth alinement requires the designer to go beyond merely assembling designs in their proper order and form. It is this aspect of channelization that is an art. Designers and traffic engineers can produce intersections that are pleasing in appearance, if they always attempt to meet these objectives:

- Maintain alinement that is smooth and continuous. Avoid abrupt transitions.
- Design each element to closely fit the natural paths and operating characteristics of drivers and vehicles.
- Maintain as level grades as practicable. This will assist in development of smooth pavement edge profiles.
- Consider the overall appearance of the intersection, both in plan view and from the perspective of the driver.

In the process of reviewing and finalizing the intersection geometry, the designer should complete a final engineering check. The following steps are suggested:

1. Verify the adequacy of all turning movements with the design vehicle(s). Particular attention should be paid to sharp angle turns, double turning lanes, and opposing left-turn movements. Where the design vehicle is a single-unit truck or bus, the designer should also evaluate the operation of a larger vehicle (such as a WB-50). Encroachments on opposing lanes or shoulders may be acceptable for infrequent, large vehicles. Possible conflicts with traffic signals, utility poles or other fixed objects, however, should not be tolerated.
2. Check and adjust the location and design of island tapers and offsets. All channelization elements should work in unison to provide guidance to the driver. This is accomplished by "funneling" traffic with the use of variable island offsets and coordinated taper geometry.
3. Check the designed location of all signs, signals and traffic control devices. Their appearance to approaching traffic should be clear and unconfusing. Adherence to MUTCD guidelines is critical. This step is particularly important for intersections with unusual geometry.
4. Check the locations of all crosswalks and islands used as pedestrian refuge. Walking distances across traffic lanes should be minimized, and paths should be clear of obstacles such as signs, light poles, etc.

### REFERENCES

- 4-1. Roads and Transportation Association of Canada, *Geometric Design Standards For Canadian Roads and Streets* (1976).
- 4-2. DAVID, N. A., AND NORMAN, J. R., "Motor Vehicle Accidents in Relation to Geometric and Traffic Features of Highway Intersections, Volume II—Research Report." *Report No. FHWA-RD-76-129* (July 1975).
- 4-3. HANNA, J. T., ET AL., "Characteristics of Intersection Accidents in Rural Municipalities." *Transportation Research Board Record 601* (1976).
- 4-4. KIHLEBERG, K. K., AND THARP, K. J., "Accident Rates as Related to Design Elements of Rural Highways." *NCHRP Report 47* (1968).
- 4-5. FOODY, T. J., AND RICHARDSON, W. C., "Evaluation of Left Turn Lanes as a Traffic Control Device." Ohio Department of Transportation (1973).
- 4-6. Jack E. Leisch & Associates, *Planning and Design Guide For At-Grade Intersection* (1978).
- 4-7. HARMELINK, M. D., "Volume Warrants for Left Turn Storage Lanes at Unsignalized Grade Intersections." *Highway Research Record 211*, Highway Research Board (1967).
- 4-8. LEISCH, J. E., "Capacity Analysis Techniques for Design of Signalized Intersections." Bureau of Public Roads, Federal Highway Administration (1967).
- 4-9. "Design Criteria for Left Turn Channelization." *Institute of Transportation Engineers Journal* (Feb. 1981).
- 4-10. "A Policy on Geometric Design of Highways and Streets." American Association of State Highway and Transportation Officials, Washington, D.C. (1984).
- 4-11. The Development of Criteria For the Treatment of Right Turn Movements on Rural Roads." Virginia Highway and Transportation Research Council Report (Mar. 1981).



*Both curb radius design and width promote easy turns off the arterial.*



*The double driveway is particularly applicable to high traffic generators such as restaurants.*



*Note the offset of the center island from through traffic lanes.*



*The driveway also accommodates pedestrian movements along the sidewalk.*

*Figure 4-37. Example design of driveway off high-speed arterial.*

- 4-12. SOLOMON, D., "Accidents on Main Rural Highways Related to Speed, Driver and Vehicle." Bureau of Public Roads (1964).
- 4-13. COTTRELL, B. H. JR., "Guidelines For the Design and Placement of Curb Ramps." *Transportation Research Board Record 923* (1983).
- 4-14. "Evaluation of Minor Improvements: Flashing Beacons, Safety Lighting, Left Turn Channelization." Traffic Department, California Department of Public Works (1967).
- 4-15. Technical Guidelines For Control of Direct Access to Highways, FHWA.
- 4-16. STAFFELD, P. R., "Accidents Related to Access Points and Advertising Signs—Minnesota Highway Study." *Traffic Quarterly* (Jan. 1953).
- 4-17. BOX, P. C., "Driveway Accident Studies, Major Traffic Routes, Skokie, Illinois." (1968).
- 4-18. Box, P. C., "Driveways." *Traffic Control and Roadway Elements—Their Relationship to Highway Safety/Revised*, Highway Users Federation for Safety and Mobility (1970).
- 4-19. GLENNON, J. C., VALENTA, J. J., THORSON, B. A., AZZEH, J. A., AND WILTON, C. J., Evaluation of Techniques for the Control of Direct Access to Arterial Highways," *Report No. FHWA-RD-76-85*; "Technical Guidelines for the Control of Direct Access to Arterial Highways, Volume I—General Framework for Implementing Access Control Techniques," *Report No. FHWA-RD-76-86*; "Volume II—Detailed Description of Access Control Techniques," *Report No. FHWA-RD-76-87*, Federal Highway Administration (Aug. 1975).

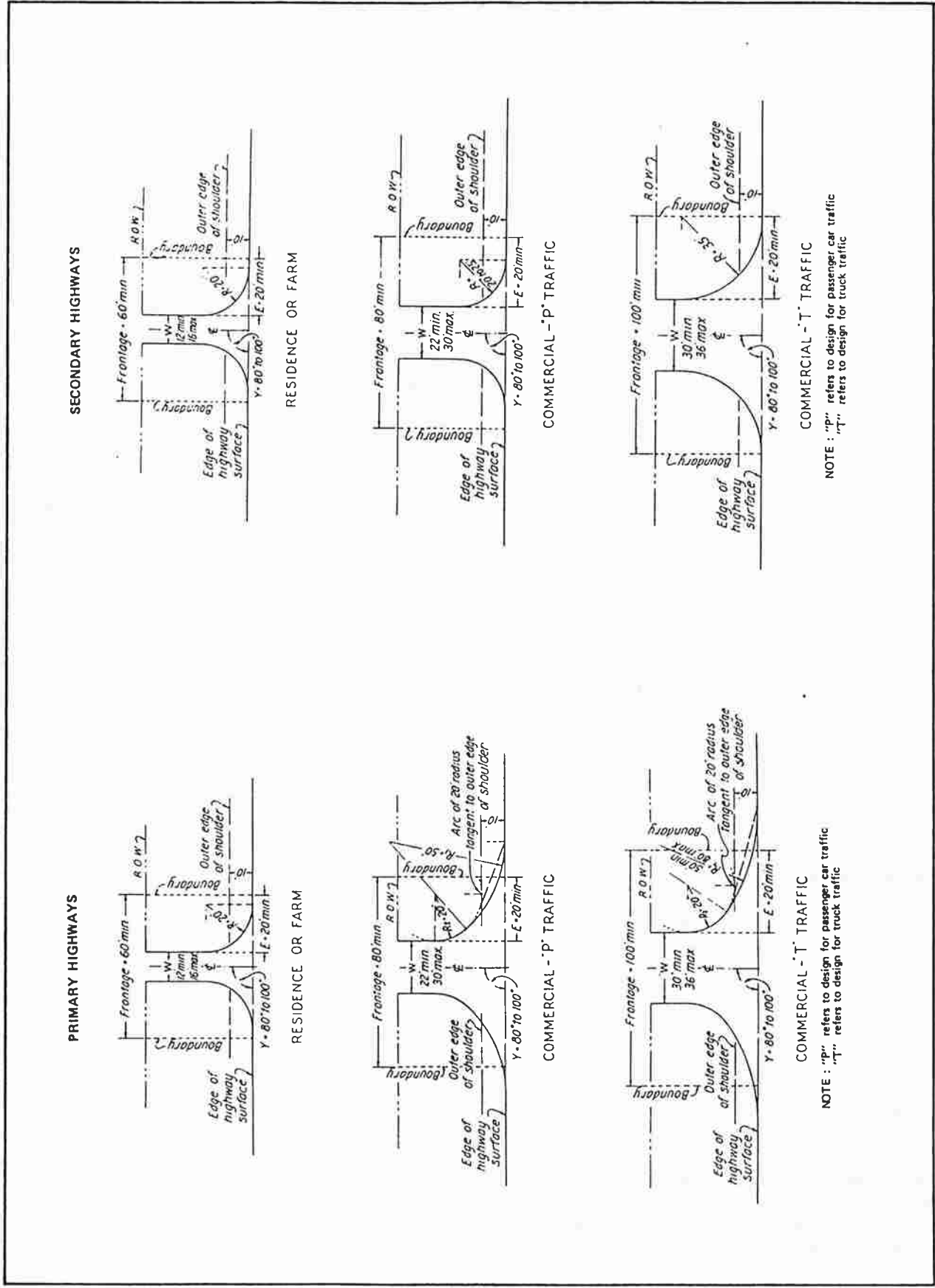
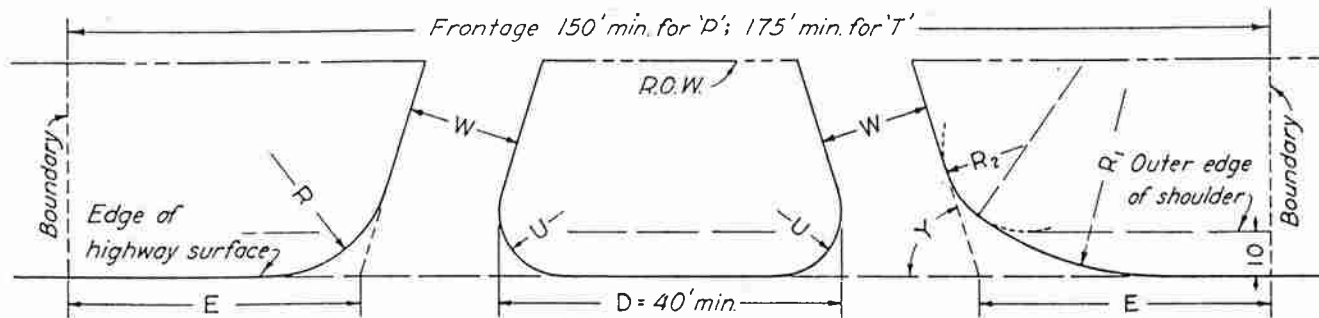

Figure 4-38. Guidelines for driveway design on rural highways. (Source: Ref. 4-6)



Y	Type of Service Traffic	W min.-max.	Class B Hwy	Class A Hwy		U		E min.
			R min.-max.	R <sub>1</sub> min.-max.	R <sub>2</sub> min.-max.	When D < 100'	When D > 100'	
45°-55°	'P'	20'-24'	35'-50'	80'	None	10'	-*	10'
	'T'	26'-30'	50'	80'	None	10'	-*	10'
60°-70°	'P'	22'-26'	30'-35'	50'	None	15'	20'	15'
	'T'	28'-32'	35'-40'	80'	20'	15'	25'	15'
75°-90°	'P'	22'-30'	20'-25'	50'	20'	20'	20'	20'
	'T'	30'-36'	35'	50'-80'	20'	20'	35'	20'

\* When  $D > 100'$ , Y should be not less than  $60^\circ$

NOTE : "P" refers to design for passenger car traffic  
"T" refers to design for truck traffic

Figure 4-39. Guidelines for design of double driveways. (Source: Ref. 4-6)

#### ADDITIONAL REFERENCES

"Highway Capacity Manual." *Special Report 87*, Highway Research Board (1965).

HAGENAUER, G. F., ET AL., "Intersections." *Synthesis of Safety Research Related to Traffic Control and Roadway Elements, Vol. I, Report No. FHWA-TS-82-232* (1982).

"Design and Use of Two-Way Left Turn Lanes." *Institute of Transportation Engineers Journal* (Feb. 1981).

"A Policy on Geometric Design of Rural Highways." American Association of State Highway and Transportation Officials, Washington, D.C. (1965).

"Guidelines for Urban Major Street Design." Institute of Transportation Engineers (1979).

"Transportation and Traffic Engineering Handbook." Institute of Transportation Engineers (1982).

"Traffic Control Devices Handbook—An Operating Guide." National Advisory Committee on Uniform Traffic Control Devices, U.S. Department of Transportation (1975).

"Manual on Uniform Traffic Control Devices for Streets and Highways." U.S. Department of Transportation (1978).

### DIVIDED HIGHWAYS WITH MEDIAN OPENINGS

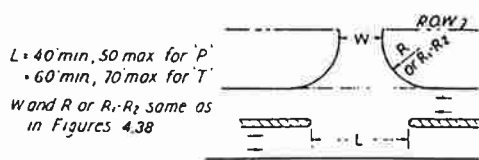

SINGLE DRIVEWAY

$L = 40$  min,  $50$  max for 'P'  
 $= 60$  min,  $70$  max for 'T'  
 Width  $R$  or  $R_1, R_2$  same as  
 in Figures 4.38

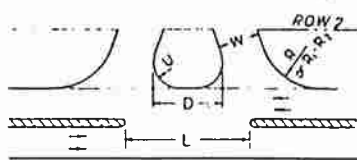

DOUBLE DRIVEWAY - SINGLE OPENING

$D = 40$  min,  $60$  max  
 $L = D + 20$  min,  $D + 30$  max  
 $W, U,$  and  $R$  or  $R_1, R_2$   
 same as in Figure 4.39

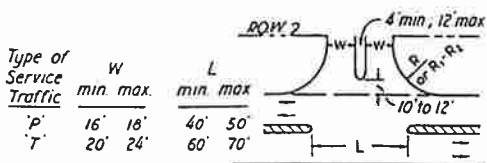

DIVIDED DRIVEWAY

Type of  
 Service  
 Traffic

Type of Service Traffic	W min.	W max.	L min.	L max.
'P'	16'	18'	40'	50'
'T'	20'	24'	60'	70'

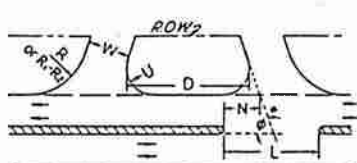
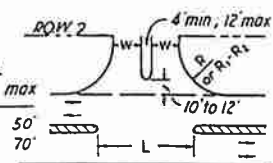

DOUBLE DRIVEWAY - SINGLE OFFSET OPENING

$D = 80$  min  
 $L = 40$  min,  $50$  max for 'P'  
 $= 60$  min,  $70$  max for 'T'  
 $W, U,$  and  $R$  or  $R_1, R_2$   
 same as in Figure 4.39  
 $N = \frac{45}{\phi} (L \cdot W)$

\*  $\phi$  = Angle of left turn from  
 traveled way to driveway, degrees

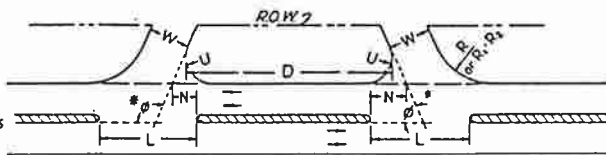

DOUBLE DRIVEWAY - DOUBLE OPENING

$D = 150$  min  
 $L = 40$  min,  $50$  max for 'P'  
 $= 60$  min,  $70$  max for 'T'  
 $W, U,$  and  $R$  or  $R_1, R_2$   
 same as in Figure 4.39  
 $N = \frac{45}{\phi} (L \cdot W)$

### DIVIDED HIGHWAYS WITHOUT MEDIAN OPENINGS

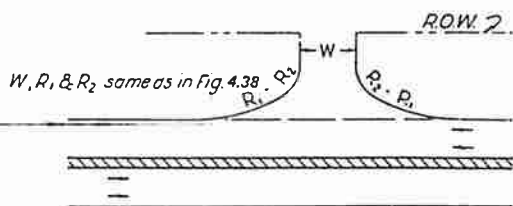

SINGLE DRIVEWAY

$W, R_1,$  &  $R_2$  same as in Fig. 4.38

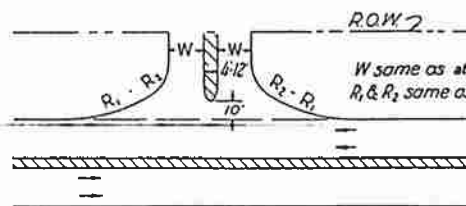

DIVIDED DRIVEWAY

$W$  same as above  
 $R_1$  &  $R_2$  same as in Fig. 4.38

Y	Type of Service Traffic	W min.-max.
45° min.	'P'	14' - 16'
	'T'	16' - 20'
60° max.	'P'	14' - 16'
	'T'	18' - 22'

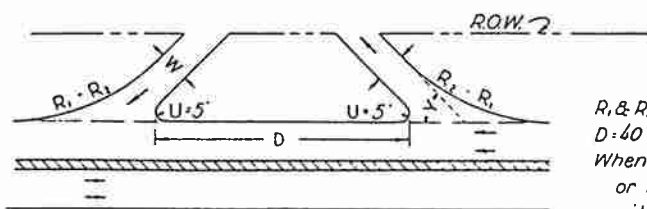

ONE-WAY DOUBLE DRIVEWAY

$R_1$  &  $R_2$  Same as in Fig 4.39  
 $D = 40$  min.,  $200$  max.  
 When  $D > 200$  use two single  
 or two divided driveways  
 with  $Y = 90^\circ \pm$

NOTE: "P" refers to design for passenger car traffic  
 "T" refers to design for truck traffic

Figure 4-40. Guidelines for design of driveways on divided highways. (Source: Ref. 4-6)

## APPLICATION OF PRINCIPLES AND GUIDELINES TO DESIGN OF CHANNELIZED INTERSECTIONS

This chapter of the Guide provides examples of intersections recently designed and/or constructed. The examples were selected from over 130 plans submitted by more than 40 design agencies throughout the country.

An effort was made to visit as many of the intersections as possible. About two-thirds of the total were visited, with field inspection and evaluation of each intersection's operations performed.

The actual selection of which intersections to depict was based on a number of considerations, including the need for:

- Geographical diversity.
- Full range of environmental and operating conditions.
- Quality of the design.
- Consistency of application of design standards.

Above all, the following design examples were chosen because they illustrate reasonable, cost effective solutions to typical design problems. As will be seen in reviewing them, the application of the basic channelization principles is clear.

The example intersections (discussion, data, and photographs) are presented on the following pages, and fold-out plans are included in the back of the Guide. The reader is encouraged to review the plans while reading the discussion and data.

Each intersection is shown with traffic data and accident summaries for a period prior to the improvement or reconstruction.

A discussion of the channelization principles applied and a brief description of the solution are also presented. For many of the intersections, photographs of either before or after the intersection was built are shown. These are labeled (a) to (f), and the location of the photograph is indicated on the plan.

All supporting data, including traffic volumes, accident histories, construction costs, and the plans themselves, were provided by the agency noted.

The examples are grouped according to the following classifications:

- Typical Intersections (Nos. 1 through 5)
- Special Geometric Problems (Nos. 6 through 12)
- Special Operational Problems (Nos. 13 through 23)
- Left Turn Design Treatments (Nos. 24 through 33)
- Special Case Studies in Rehabilitation and Reconstruction (Nos. 34 through 37)

As can be seen from Table 5-1, Intersections 1 through 33 represent a wide range of intersection types. Intersections 34 through 37 represent special case studies in rehabilitation or reconstruction of intersections. Each case study illustrates application of channelization principles to solve an existing operational or safety problem.

Table 5-1

INTERSECTION NUMBER	INTERSECTION TYPE AND LOCATION	SUBMITTING AGENCY
1	Typical Rural T-type	Iowa DOT
2	Typical Rural 4-leg	Kansas DOT
3	Typical Rural (Divided Highway)	North Carolina DOT
4	Typical Urban 4-leg	New York DOT
5	Typical Interstate Ramp Intersection	Louisiana DOT
6	Intersection on Horizontal Curve	California DOT
7	Rural Skewed Intersection	New Hampshire DOT
8	Rural Skewed Intersection	North Carolina DOT
9	Urban Multileg/Skewed Intersection	Washington D.C. DPW
10	Urban Multileg Intersection	New Hampshire DOT
11	Urban Offset Intersection	Tennessee DOT
12	Urban Intersection With Route Turn	Minnesota DOT
13	Urban Capacity Problem	Montana DSH
14	Suburban Capacity Problem	Georgia DOT
15	Urban Access Control Problem	New Hampshire DOT
16	Suburban Access Control Problem	Kansas DOT
17	Rural Design For Large Vehicles	Arkansas DOT
18	Rural Design For Large Vehicles	Illinois DOT
19	Urban Design For Large Vehicles	Illinois DOT
20	Urban Design For Large Vehicles	Montana DOT
21	Suburban Bicycle Lanes	Ohio DOT
22	Suburban High Volume Turns	Lake County, Ill. H.D.
23	Urban Right Turn Problem	California DOT
24	Rural Left Turn (Low Volume)	Lake County, Ill. H.D.
25	Suburban Left Turn	Illinois DOT
26	Rural Left Turn (Two-lane Highway)	Montana DSH
27	Rural Left Turn (Divided Highway)	Kent County, Mich, H.D.
28	Rural Left Turn (Divided Highway)	Illinois DOT
29	Suburban Special Left Turn (Jug Handle)	New York DOT
30	Suburban Special Left Turn (Crossover)	Michigan DOT
31	Continuous Two-way Left Turn Lane	North Carolina DOT
32	Continuous Two-way Left Turn Lane	New York DOT
33	Continuous Two-way Left Turn Lane	New York DOT
34	Urban Case Study in Rehabilitation	Georgia DOT
35	Rural Case Study in Rehabilitation	North Carolina DOT
36	Urban Case Study in Rehabilitation	California DOT
37	Urban Case Study in Rehabilitation	New Hampshire DOT

INTERSECTION NO. 1

U.S. Route 65 and State Route 175  
 Hardin County, Iowa  
 (Submitted by Iowa Department of Transportation)

Typical Rural T-type Intersection

Prevailing Speeds on Approach Roadways -- 50 mph

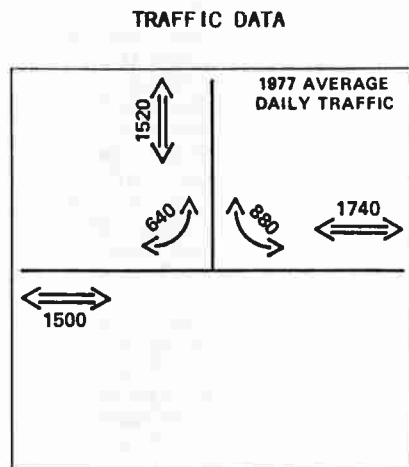

**ACCIDENT DATA**  
 (5 Years -- 1974-1978)

Total Accidents	4
Fatal Accidents	0
Injury Accidents	1
Property Damage Only	3

Accidents By Type

Rear-end	2
Single Vehicle	2

**PRE-IMPROVEMENT OPERATIONAL CHARACTERISTICS**

The intersection was originally constructed as a high-speed Y-connection for the U.S. Route 65 north to west movement. Realignment of Route 65 necessitated construction of a new intersection.

**DESIGN PRINCIPLES APPLIED TO ACHIEVE OPERATIONAL AND SAFETY OBJECTIVES**

The primary objective in developing a new design was to produce an intersection consistent with the character and volume of each highway. Simplicity in design and adherence to principles of driver expectancy were important considerations. This included easing the task of drivers queued on the stopped approach by replacing the unusual Y-type design with a more conventional T-type crossing. The design reflects the following principles:

- **Removal of decelerating, stopped or slow vehicles from through lanes**  
 (Left turns from west to north)
- **Crossing conflicts at right angles**  
 (Use of right angle T-type intersection)



### SUMMARY OF DESIGN SOLUTION

- (1) Existing Y-type intersection was obliterated.
- (2) New T-type intersection with southbound stop control and right turn channelization was constructed.
- (3) A safety ramp south of State Route 175 was constructed because of the downgrade on the southbound approach of U.S. Route 165.



a. Drivers approaching from the north have a clear view of the intersection and traffic control.



b. The channelization enables large truck turns, separate storage of one queued left turning vehicle, and placement of stop signs within the driver's cone of vision.



c. Painted channelization provides separation of opposing flows, protection for the west to north left turn lane, and visual notice of the intersection.



d) and e) The long taper develops a left turn lane for west to north movements.



f) Rumble strips and advance signing add to cues to drivers approaching from the north.

INTERSECTION NO. 2

U.S. Route 24 and U.S. 81  
 Cloud County, Kansas  
 (Submitted by Kansas Department of Transportation)

Typical Rural 4-leg Intersection

Prevailing Speeds on Approach Roadways -- 55 mph

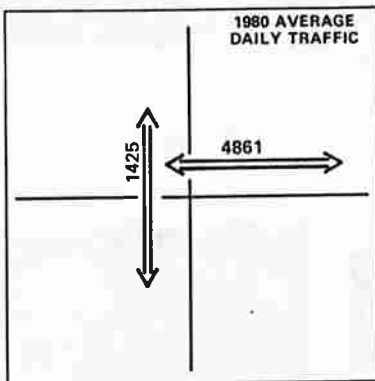
**TRAFFIC DATA****ACCIDENT DATA**

(1/1/72 - 10/25/81)

Total Accidents	6
Fatal Accidents	1
Injury Accidents	0
Property Damage Only	5

**Accidents By Type**

Rear-end	2
Angle	2
Head-on	1
Sideswipe	1

**PRE-IMPROVEMENT OPERATIONAL CHARACTERISTICS**

Both U.S. Route 81 and U.S. Route 24 are primary arterials in a rural area. Their right angle intersection previously operated under 4-way stop control, with both highways widened to two approach lanes with a 4-foot raised median.

Operational studies of the intersection were performed as part of a planned upgrading of U.S. 81. It was found that U.S. 81 carries about 3.5 times the traffic that U.S. 24 does. Observations of vehicles on U.S. 81 showed a propensity to "roll" the stop sign when no conflicting traffic was present. Indications were that both the intersection's appearance and type of traffic control were inappropriate, given the great imbalance in traffic volumes on the two highways.

**DESIGN PRINCIPLES APPLIED TO ACHIEVE OPERATIONAL AND SAFETY OBJECTIVES**

The objective in re-designing the intersection was to provide an overall, "balanced" design, i.e., one that reflects traffic patterns. Priority was given to U.S. Route 81 by converting the intersection to 2-way stop control, with U.S. Route 24 traffic stopped in favor of Route 81.

Achieving this objective required careful consideration of principles of driver expectancy. It also required understanding of the relationship between traffic control and intersection geometrics. The following principles of channelization are evident:

- **Facilitation of high priority movements** (U.S. Route 81 traffic)
- **Removal of decelerating and stopped vehicles from higher speed traffic**  
 (Left turns from U.S. Route 81)
- **Facilitation of traffic control schemes** (Approach geometrics on both highways)

## SUMMARY OF DESIGN SOLUTION

- (1) The traffic control was converted from a 4-way stop to a 2-way stop, with US Route 81 traffic uncontrolled (i.e., designated as through).
- (2) U.S. Route 24 approaches were reduced to single lane in each direction.
- (3) U.S. Route 81 approaches were channelized, with left turn lanes provided to shield decelerating left turns from through traffic.
- (4) Large radius (75-foot) returns were provided in all quadrants.
- (5) Raised median channelization was removed from both highways.

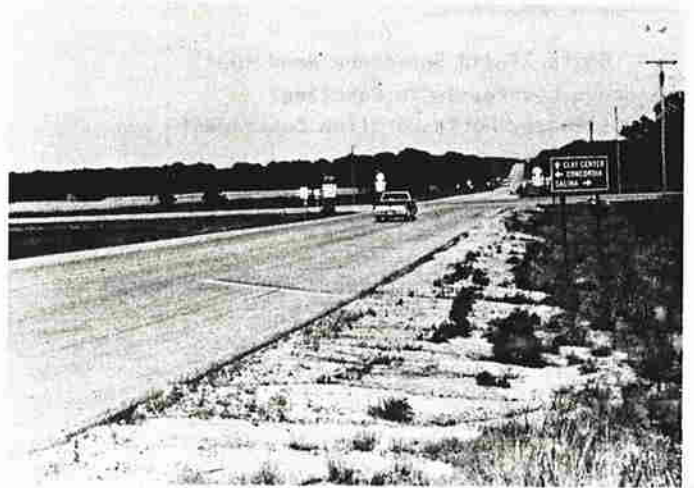

(a) The approach taper for the left turn lane and excellent sight lines provide clear notice of the intersection to through drivers on U.S. 81.

(b) and (c) The design of the left turn lane requires turning vehicles to make a positive maneuver into the lane. Pavement arrows confirm the lane designation.



(d) Excellent sight distance is available in all quadrants of the intersection. All signs were relocated inside a 1500-foot sight line on the approaches to U.S. Route 24.

(e) The approaches on U.S. 24 were reduced to one lane, with the former right lane striped out. This 1) provides visual notice of the intersection; and 2) gives a distinctly different appearance to the stopped approach (as in the above photos).

(f) Note the 75-foot radius return and sight distance from the stopped approach on U.S. 24.

This intersection illustrates the importance of reviewing accident and operational data after implementing an improvement. The change in traffic control was not sufficiently noted by all drivers, resulting in potentially hazardous operations. In the spring of 1983, additional traffic control devices (additional stop signs, 12-inch flashing red beacons, and yellow warning beacons on approaches to U.S. 81) were placed to heighten driver awareness.

INTERSECTION NO. 3

U.S. Route 74 and Secondary Road 1001  
 Columbus County, North Carolina  
 (Submitted by North Carolina Department  
 of Transportation)

Typical Rural 4-leg Intersection on Divided Highway

Prevailing Speeds on Approach Roads -- 55 mph

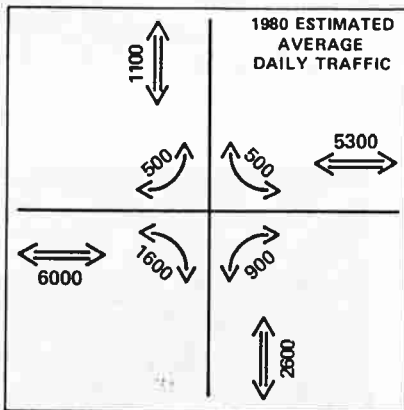
**TRAFFIC DATA****ACCIDENT DATA**

Not Applicable --  
 U.S. Route 74 is  
 being constructed  
 on new alignment

**PRE-IMPROVEMENT OPERATIONAL CHARACTERISTICS**

The intersection is included in a major project to construct a 4-lane divided U.S. 74 highway on new location. The intersection will operate under stop control for Secondary Road 1001.

**DESIGN PRINCIPLES APPLIED TO ACHIEVE OPERATIONAL AND SAFETY OBJECTIVES**

Intersections such as this one should provide for safe execution of all turning maneuvers, with minimal impact on the high-speed, major facility. The wide median and its effect on intersection operations is an important consideration. The following design principles apply:

- **Removal of decelerating, stopped or slow vehicles from higher-speed traffic**  
 (Left turns from U.S. Route 74, and right turns from U.S. Route 74)
- **Separation of points of conflict**  
 (opposing movements on Secondary Road 1001)

## SUMMARY OF DESIGN SOLUTION

(1) Left turn lanes and long tapers are provided for turns from U.S. Route 74 regardless of traffic volume. This design provides about 350 feet for deceleration and braking.

(2) Deceleration tapers are also provided for right turning vehicles to enable deceleration outside the through lanes.

(3) Raised median channelization is used on the minor approaches to separate opposing flows. This also provides a strong visual cue of the intersection to drivers approaching on the minor legs.

(4) Three-centered curves are designed in all four quadrants to closely match the turning radius of a WB-50 vehicle.

(5) Right turn channelization is provided for the minor approach with significant expected future traffic. This will allow the right turn to operate independently of queued through and left-turning vehicles.



This intersection is in the final design stages. The following photos are of an existing, similar intersection in North Carolina. The design concept is typical of state policy for intersections on high-speed, divided highways with moderate crossing volumes.



(a) Raised median channelization on the minor approach separates opposing movements and provides a visual cue of the intersection.



(b) The median island is used to post stop signs.



(c) and (d) Raised median channelization is effective in guiding vehicles across the intersection.

Turning lanes not only provide for safe deceleration, but also provide approaching drivers with advance notice of the intersection. This is illustrated in the photo at the top of the page.

INTERSECTION NO. 4

U.S. Route 1 and State Route 125/Hommocks Road  
 Mamaroneck, New York  
 (Submitted by New York Department of Transportation)

Typical Urban 4-leg Intersection

Prevailing Speeds on Approach Roads -- 45 mph on U.S. Route 1  
 25-30 mph on State Route 125

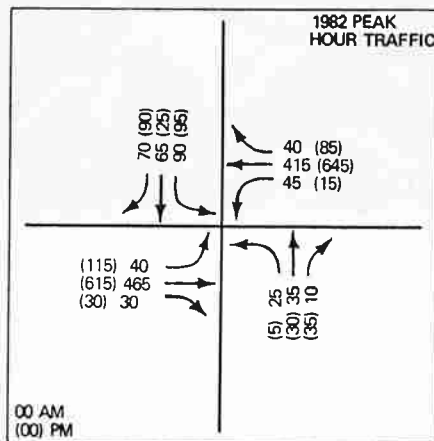
**TRAFFIC DATA****ACCIDENT EXPERIENCE**

(4.5 Years--1975 - 1979)

Fatal Accidents	0
Injury Accidents	10
Property Damage Only Accidents	38
Total Accidents	48
Accidents By Type	
Rear-end	18
Turning (Left)	13
Sideswipe	10
Right Angle	3
Other	4

**PRE-IMPROVEMENT OPERATIONAL CHARACTERISTICS**

U.S. Route 1 is a high speed (45 mph) principal arterial carrying through traffic, including many large trucks. The west leg of the intersection is State Route 125, which is also a principal arterial. The east leg, Hommocks Road, serves a residential community. A school is about one block to the west of the intersection.

This signalized intersection was a local concern for years because of its accident history and close proximity to the school. Route 1 lacked left turn lanes, resulting in rear-end and left turn involved accidents. Route 125 had a restricted width which produced poor level of service during peak periods. There was no provision for pedestrian crossings of Route 1.

**DESIGN PRINCIPLES APPLIED TO ACHIEVE OPERATIONAL AND SAFETY OBJECTIVES**

The primary safety objectives were to reduce the potential for serious pedestrian involved accidents, and to reduce the frequency of left turn and rear end accidents. Operational objectives were primarily to increase the level of service of the intersection during peak hours. The following principles were applied:

- **Facilitation of traffic control**  
 (Pedestrian crossings and left turn phasing)
- **Removal of decelerating and stopped vehicles from through lanes**  
 (Left turns from Route 1)
- **Controlling speeds**  
 (Increasing speeds of right turning vehicles from Route 1)

**DESIGN CONSTRAINTS**

Adjacent land use necessitated a channelization solution within the existing width on U.S. Route 1.

## SUMMARY OF DESIGN SOLUTION

- (1) Pedestrian signals were installed for all crosswalks. Amber times were also increased for all approaches.
- (2) Left turn lanes were provided on both approaches of U.S. Route 1.
- (3) State Route 125 was widened to provide a left turn lane and 14-foot through lanes in each direction.
- (4) Corner radii were increased to facilitate right turning vehicles.



(a) and (b) Painted left turn lanes (10 feet in width) are provided within the existing cross section of U.S. Route 1. These lanes not only remove turning vehicles from the higher speed through lanes, they also enable the introduction of a range of signal phasing schemes.

(c) Pedestrian actuated crossing signals were provided for all crosswalks. Of particular importance is the crossing of wide, high-speed U.S. Route 1.

Also note the handicapped ramps provided along the new curb return.



(d) State Route 125 is widened to provide a left turn lane and 14-foot departure lane width. The increased corner radius also results in additional throat width available for vehicles turning left from northbound U.S. Route 1.

(e) Right turn operations from southbound U.S. Route 1 to State Route 125 were significantly improved by increasing the corner radius to 40 feet.

(f) Channelization design improvements to State Route 125 provide the flexibility to handle momentary peak traffic loads as well as other operational requirements. Queuing in both lanes occurs during an extended all red phase initiated by a pedestrian crossing U.S. Route 1. This queue dissipated in the next green phase.

INTERSECTION NO. 5

U.S. Routes 71, 165 and 167 and  
Freeway Ramp from Eastbound Interstate 49  
Alexandria, Louisiana

Urban Area

Prevailing Speeds on Approach Roadways -- 40-50 mph

**TRAFFIC DATA****ACCIDENT EXPERIENCE**

Not Applicable -- The intersection is planned and designed as part of a new freeway.

**PRE-IMPROVEMENT OPERATIONAL CHARACTERISTICS**

Not Applicable

**DESIGN PRINCIPLES APPLIED TO ACHIEVE OPERATIONAL AND SAFETY OBJECTIVES**

The intersection of a freeway ramp and divided arterial intersection is part of a new freeway system. The interchange configuration, a PARCLO-A, is typical of high-type urban service interchanges. Its basic operation, which produces single exit operation, no weaving, and 2-phase signalization, is designed to safely accommodate high turning volumes both on and off the freeway.

In designing the new at-grade intersection, a number of basic channelization principles are applied:

- **Prohibition of Wrong-way Movements** (Potential wrong-way left turns into the ramp)
- **Definition of Vehicle Paths**  
(Ramp turning movements)
- **Facilitation of Traffic Control Schemes**  
(Operation of 2-phase signalization)



INTERSECTION NO. 6

State Route 191 and West Watmaugh Road  
 Sonoma County, California  
 (Submitted by California Department of  
 Transportation)

Rural Intersection on Horizontal Curve

Prevailing Speeds on Approach Roadways -- 40-45 mph

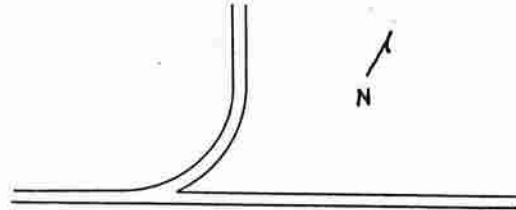
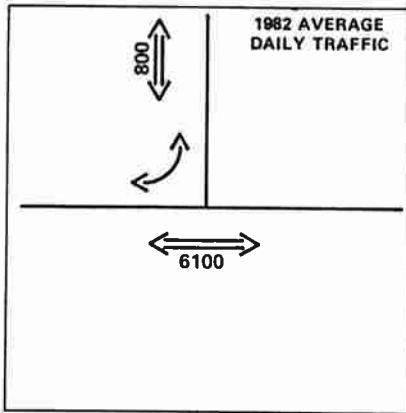
**TRAFFIC DATA****ACCIDENT EXPERIENCE**  
(1980-1982)

Total Accidents --	14
Property Damage	8
Injury Accidents	6
Fatal Accidents	0
Accidents By Type	
Single Vehicle	3
Multiple Vehicle	11

**PRE-IMPROVEMENT OPERATIONAL CHARACTERISTICS**

West Watmaugh Road is a minor county highway that intersects with State Route 116, a major rural arterial connecting Sonoma to the east and Petaluma to the west. Each facility is 2 lanes (one each direction). No separate turning lanes exist.

The actual intersection is a Wye-type connection, with West Watmaugh Road on a 125-foot radius curve. Traffic on West Watmaugh Road is stop controlled.

The combination of approach geometry, intersection configuration and restricted cross section create a hazardous intersection, despite the relatively low traffic volumes. The horizontal curve creates poor sight angles for vehicles stopped on West Watmaugh Road, looking to the east. It also impedes left turns for these vehicles onto eastbound Route 116. Left turns off Route 116 are hazardous also. Available gaps are limited due to the rolling terrain, low relative speeds, and traffic volumes. No protection for queued vehicles is provided.

The geometric and traffic conditions account for the large number of rear-end accidents at the intersection. From 1980 to 1982, 8 of 14 accidents were of the rear-end type. A total of 16 injuries was recorded in these 3 years.

**DESIGN PRINCIPLES APPLIED TO ACHIEVE OPERATIONAL AND SAFETY OBJECTIVES**

The objective in re-designing this intersection is to improve the safety of turning maneuvers. Both horizontal alignment and cross sectional changes, in addition to appropriate channelization, were considered. The following design principles apply:

- **Vehicle streams should cross at right angles** (Alignment of the intersection of West Watmaugh Road into State Route 116)
- **Removal of slow or stopped vehicles from through lanes** (Left turns from State Route 116)
- **Facilitation of high priority movements** (Through traffic on State Route 116 presently delayed by left turning traffic onto West Watmaugh Road)

INTERSECTION NO. 7

State Route 101 and Portsmouth Avenue/  
 State Route 151  
 Greenland, New Hampshire  
 (Submitted by New Hampshire Department of  
 Public Works and Highways)

Rural Intersection on Skew

Prevailing Speeds on Approach Roadways -- 50 mph on State Route 101  
 35 mph on Portsmouth Ave.

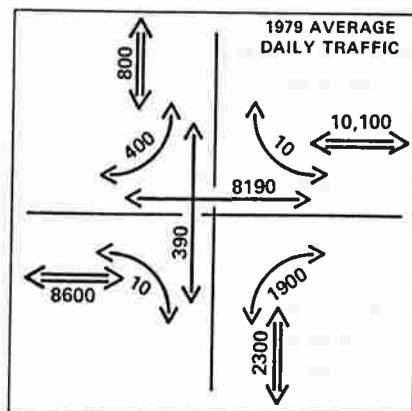
**TRAFFIC DATA****ACCIDENT EXPERIENCE**  
(2 Years)

Total Accidents	12
Fatalities	1

**PRE-IMPROVEMENT OPERATIONAL CHARACTERISTICS**

State Routes 101 and 151 form a 45° intersection in a rural area just west of Portsmouth, New Hampshire. Route 101, the major facility, is a high-speed two lane highway with through (priority) control. Route 151 is stop-controlled on both approaches. The rolling terrain and profiles of both highways result in poor sight distance for drivers approaching on Route 151. The difficult sight lines created by the skew further aggravate operations on the minor approach.

Increased traffic volumes, combined with the poor geometrics, resulted in 12 accidents and 1 fatality in a recent 2-year period. The Intersection was thus a candidate for improvement.

**DESIGN PRINCIPLES APPLIED TO ACHIEVE OPERATIONAL AND SAFETY OBJECTIVES**

Reduction in the frequency and severity of crossing conflicts and accidents was the primary objective. This was achieved through revisions to intersection geometry and traffic control. The selected design solution was also sensitive to future potential capacity and safety problems. Treatment of the safety problem involved application of the following principle:

- **Separation of Conflicts**

(Signalization enabled time separation of the troublesome crossing conflicts)

The following principles are reflected in the design solution, which recognizes the potential effects of traffic increases and the geometric requirements of signalized intersections.

- **Removal of decelerating or stopped vehicles from high-speed through traffic**

(Left turns from State Route 101 and right turns from State Route 101)

- **Facilitation of traffic control schemes**

(Left turn lanes and separate signals)

- **Facilitation of high priority movements**

(Angle of intersection and predominant turning movements)

## SUMMARY OF DESIGN SOLUTION

(1) The Intersection is signalized to eliminate skew and sight distance-related crossing conflicts, and to enable safe movements to and from the minor highway (State Route 151).

(2) Widening of all intersection approaches is provided for capacity and safety. The widening enables development of separate left turn lanes on State Route 101, separate right turn lanes on all legs, and median channelization to separate opposing traffic.

(3) Right turn channelization is improved in all quadrants to facilitate turning movements.

(4) All channelization is developed to provide for possible conversion to future raised channelization.

Note that the original skew angle has not been altered. Construction of a conventional 90° intersection was not considered viable due to right-of-way and construction costs. Instead, signalization is used to treat the skew-related conflicts.



(a) The approach taper for the left turn lane begins in advance of the horizontal curve.



(b) View of approach from the west. Note the fully shadowed left turn lane and visibility of overhead traffic signals.



(c) Right turn lanes are developed for the acute angle turn despite the low demand volumes. The angle requires a very low speed turn, hence the need to separate right turns from high speed through traffic.



(d) The corner islands are offset a full lane width from the edge of the through lane.



(e) Lane arrangements on the minor approaches reflect traffic volume patterns. Opposing volumes and left turn volumes are low enough to combine left and through traffic in a single lane.



(f) Note the great crossing distance and open pavement area created by the skew angle. The installation of traffic signals provides a means of reducing exposure to crossing conflicts within this intersection.

INTERSECTION NO. 8

U.S. Route 70 and State Route 12  
 Carteret County, North Carolina  
 (Submitted by North Carolina Department  
 of Transportation)

Rural Intersection on Skew

Prevailing Speeds on Approach Roadways -- 55 mph

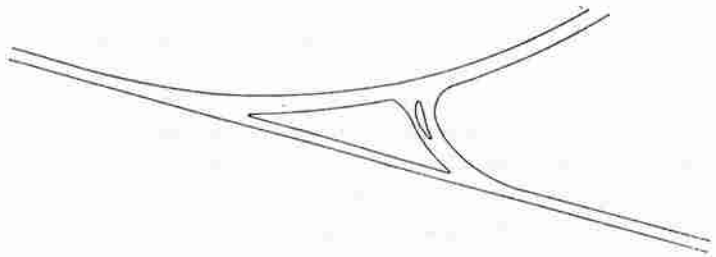

**TRAFFIC DATA**

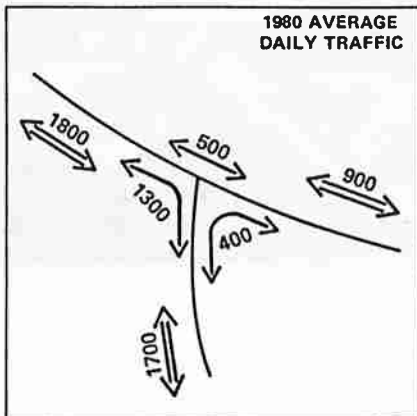

**ACCIDENT EXPERIENCE**  
 (2 Years and 11 Months)

Total Accidents -- 3

**PRE-IMPROVEMENT OPERATIONAL CHARACTERISTICS**

The original intersection was of a Y-type (large angle skew) form. Both highways carry low traffic volumes, with most of the traffic oriented along U.S. Route 70.

The high-speed character, small angle of intersection, and orientation of traffic created a potentially hazardous intersection. Drivers approaching on stop-controlled State Route 12 had a very mild "turn" onto westbound U.S. Route 70. Violations of the stop control were thus encouraged by the alignment. These same drivers experienced difficulty in seeing vehicles arriving from the left, due to the angle of intersection. Drivers traveling through on Route 70 were encouraged to maintain high speeds by the appearance of the intersection. This combination of factors created potentially severe (high-speed) conflicts involving turning vehicles.

**DESIGN PRINCIPLES APPLIED TO ACHIEVE OPERATIONAL AND SAFETY OBJECTIVES**

In re-designing the intersection, the basic objective was to improve the safety of the intersection by limiting the severity of crossing and turning conflicts. Also, reducing the complexity of the conflict area, thereby facilitating turning maneuvers, was a priority. The following design principles were applied:

- **Controlling of speeds**  
 (High speed U.S. Route 70 traffic)
- **Facilitation of traffic control schemes**  
 (Establishment of clear right of way and stop condition for all approaches)
- **Definition of vehicular paths**  
 (Turning movements between Route 70 and 12)

**DESIGN CONSTRAINTS**

The intersection was redesigned as part of a larger reconstruction project on U.S. Route 70. Location of the intersection was influenced by the new alignment of the western approach.

## SUMMARY OF DESIGN SOLUTION

(1) The new alignment is a T-type Intersection of about 90°. Continuity is given to the western leg of U.S. Route 70 and State Route 12. The eastern leg of Route 70 is stop controlled. This design controls speeds of traffic along Route 70, clearly defines traffic control, and optimizes sight lines in both directions for stopped traffic.

(2) A median island (typical North Carolina design) of mountable nature is provided on the eastern leg of U.S. 70. It separates opposing flows, and is used to locate the stop sign.

(3) A right turn lane for "through" traffic on U.S. Route 70 is provided.

The overall character of the intersection results in a more conventional, understandable intersection for drivers approaching from all legs. Through continuity along U.S. Route 70 is not retained by this design. However, with speeds of vehicles controlled, and ease of turns increased, the overall safety of the intersection should be improved.



(a) The eastern approach of Route 70 is brought in at right angle and stop-controlled. The median island stores a stop sign and provides separation from opposing turning vehicles. Note the offset of the median nose from the painted centerline.



(b) and (c) The new alignment provides good sight angles to both legs for drivers at the stop line. Note the cleared roadsides which provide sufficient corner sight distance.



(d) and (e) A right turn lane is provided for eastbound U.S. Route 70 vehicles. Note the smooth taper. Also note the full lane offset of the median island nose.



(f) The mountable, raised median island also serves as a visual cue of the intersection, yet does not represent an impact hazard to errant vehicles.

The location of the old alignment can be visualized from the left photograph.

INTERSECTION NO. 9

Constitution Avenue, N.W., 4th Street, and  
 Pennsylvania Avenue, N.W.  
 Washington, D.C.

(Submitted by Washington D.C. Department  
 of Public Works)

Urban Multi-leg Intersection on Skew

Prevailing Speeds -- 30 mph

**TRAFFIC DATA**

None available prior  
 to construction

**ACCIDENT EXPERIENCE**

(Recent Years)

Total Accidents --  
 Approximately 50 per year

**PRE-IMPROVEMENT OPERATIONAL CHARACTERISTICS**

Constitution Avenue, Pennsylvania Avenue and 4th Street form a six-leg intersection. The major traffic movements occur on Constitution and Pennsylvania, which intersect at a severe skew angle. Both streets are very wide, with Pennsylvania Avenue carrying 8 lanes of traffic and Constitution Avenue 6 lanes. 4th Street carries 4 lanes of traffic.

The multi-leg configuration, severe skew, cross sections and high traffic volumes created a hazardous and inefficient intersection. Traffic signal schemes were constrained by the many required movements and long signal clearance times. Pedestrian crossings were also difficult. (The intersection is near many Federal buildings, including the U.S. Capitol, and experiences high pedestrian volumes.)

**DESIGN PRINCIPLES APPLIED TO ACHIEVE OPERATIONAL AND SAFETY OBJECTIVES**

The existing intersection resulted in many conflicts occurring within a large, single intersection. Both safety and operational efficiency suffered as a result. The following channelization principles are evident in the re-designed intersection:

- **Separation of points of conflict**  
 (Multiple turning movements within the one intersection)
- **Provide crossing of traffic streams at right angles**  
 (Elimination of severe skew angle)
- **Reduction in conflict area**  
 (Large single intersection)
- **Facilitation of traffic control schemes**  
 (Improved geometry enables more efficient clearance and phasing)

**DESIGN CONSTRAINTS**

Grade separation of Pennsylvania and Constitution was considered a viable traffic engineering solution. However, such a solution would be unacceptable aesthetically for what is considered the "front" of the nation's capital.

## SUMMARY OF DESIGN SOLUTION

(1) Both approaches of Constitution Avenue were realigned to create new intersections. This resulted in three 3-leg intersections replacing the single 6-leg intersection. The alignment of Constitution resulted in intersection spacings of 360 feet, 340 feet, 380 feet and 320 feet, measured from 6th Street to 3rd Street along Pennsylvania Avenue.

(2) Double left turn lanes for each direction of traffic along Pennsylvania Avenue were provided. These serve the effective route overlap created by the new geometrics.

(3) Pedestrian crossings of Pennsylvania were restricted to the 4th Street intersection. This aided signalization and traffic movements of the new Constitution Avenue intersections.

(4) 4th Street was restriped to provide additional lanes, thereby reducing signal times for this approach.



(a) and (b) Well-marked double left turn lanes and turn Constitution Avenue traffic into a 36-foot throat.

(c) The overlap section of Pennsylvania Avenue (between the legs of Constitution Avenue) is 9 lanes wide.



(d) The new angle of intersection of Constitution Avenue is about 45°, which is an improvement over the previously very shallow angle.

(e) and (f) Pedestrian movements across Pennsylvania Avenue are restricted to the 4th Street intersection, where pedestrian actuated signals are provided. Handicapped ramps are installed at all pedestrian crossings.

INTERSECTION NO. 10

Intersection of Mammoth, Candia, Hayward  
and Massabesic Streets  
Manchester, New Hampshire  
(Submitted by New Hampshire Department of  
Public Works and Highways)

Urban Multi-leg Intersection

Prevailing Speeds on Approach Streets -- 25 - 30 mph

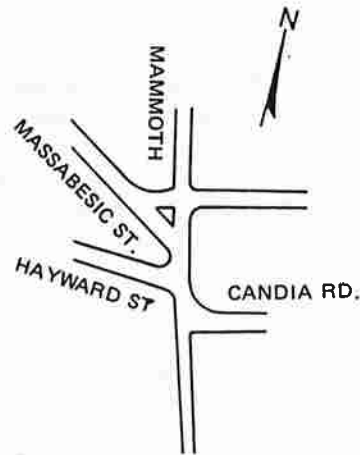
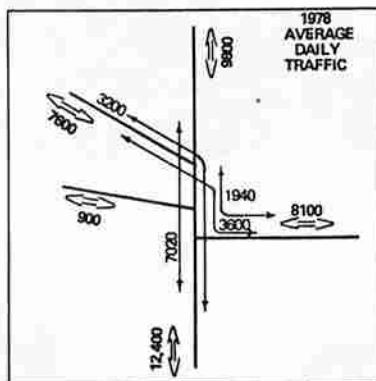
**TRAFFIC DATA****ACCIDENT EXPERIENCE**

(3 Years)

49 Accidents  
1 Fatality  
26 Injuries

**PRE-IMPROVEMENT OPERATIONAL CHARACTERISTICS**

This was a complex, unsignalized intersection of two minor arterials (Massabesic Street and Mammoth Road) with other local streets. The combination of multiple, converging legs and unusual geometry created a poor operational condition. Multiple conflicts occurred between through movements on Mammoth Road and major east to west movements using Massabesic Street and Candia Road.

Significant delays and a poor safety history led to the re-design of this intersection.

**DESIGN PRINCIPLES APPLIED TO ACHIEVE OPERATIONAL AND SAFETY OBJECTIVES**

The primary objective was to promote safe, orderly flow of significant through movements. It was necessary to retain the basic approach geometry because of adjacent land use. To accomplish this objective, a plan was developed that emphasized control of access and facilitated significant movements. The following design principles are reflected in this plan:

- **Facilitation of high priority movements**  
(Mammoth Road and Candia Road/Massabesic Street)
- **Separation of points of conflict**  
(Approach leg of Massabesic Street)
- **Prohibition of undesirable movements**  
(Access within the intersection and minor left turn movements)
- **Facilitation of traffic control schemes**  
(Lane arrangements and control of access enable signal phasing)

**DESIGN CONSTRAINTS**

A historic building located in the northeast corner of Mammoth Road/Candia Road intersection limited acquisition of right-of-way for widening or relocation of Candia Road.



## SUMMARY OF DESIGN SOLUTION

- 1) Mammoth Road was widened to provide two lanes in each direction.
- 2) Massabesic Street was realigned directly opposite Wayland Avenue to provide separation from Candia Road.
- 3) Raised median channelization along Mammoth Road, and restricted access within the intersection complex, were used to facilitate movements through the intersection.
- 4) Traffic signals and separate turning lanes coordinated all movements. Because of the short storage available on Mammoth Road, the signal phasing was designed to accommodate the heavy Massabesic Street to Candia Road movements.



(a) and (b) Massabesic Street is realigned at its approach to Mammoth Road. This creates two separate intersections with about 180 feet of storage between them. Improved sight angles and left turns also result from this realignment which produces an angle of intersection of almost 90°.

(c) A wide exit throat is provided to Massabesic Street to receive the high volume left turn movement. A significant number of semi-trailers was observed making this turn, which, in all cases, was achieved without difficulty.

Note the combined visual effect of the raised channelized median islands, pavement markings and traffic signal locations.



(d) Median channelization and signing prevent left turns from Hayward Street, which intersects Mammoth Road between Massabesic Street and Candia Road. Maintenance of traffic flow, contingent on coordination of signal phasing for all movements, requires strict control of access.

(e) and (f) Good geometrics and coordination of signal phases produce smooth operation for even the largest vehicles. Here, a semi-trailer proceeds eastbound from Massabesic Street to Candia Road. Completion of the left turn was accomplished despite the presence of queued vehicles in opposing lanes.

(Note the right turning semi-trailer from Candia Road.)

INTERSECTION NO. 11

E. Church Street and Bernard Avenue  
 Greeneville, Tennessee  
 (Submitted by Tennessee Department of  
 Transportation)

Offset Intersections

Prevailing Speeds on Approach Streets -- 25 - 30 mph

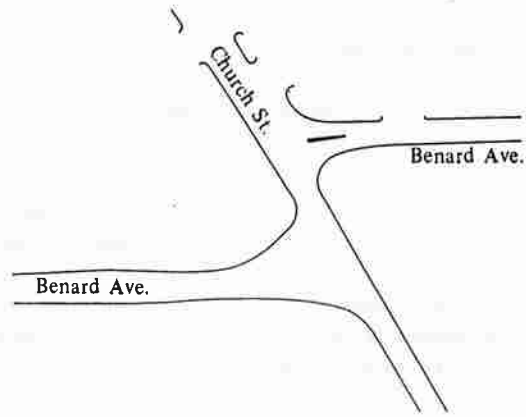

**TRAFFIC DATA**

<b>1982 PEAK HOUR</b>	
22 (34) 126 (177) 62 (102)	69 (85) 99 (189) 72 (109)
29 (23) 102 (110) 51 (58)	49 (79) 128 (125) 103 (116)
00 - A.M. (00) - P.M.	

**ACCIDENT EXPERIENCE**

(1973 - 1976)

Total Accidents 49  
 Total Injuries 9  
 Total Fatalities 0

Accidents By Type  
 Angle/Turning 23  
 Rear end 13  
 Single Vehicle 5  
 Sideswipe 1

**PRE-IMPROVEMENT OPERATIONAL CHARACTERISTICS**

Bernard Avenue forms an offset, unsignalized intersection with Church Street. The offset, which is about 150 feet, forces "through" traffic on Bernard Avenue to make a left and then right turn across Church Street, which is the priority street. The east leg of Bernard Avenue is striped as a Y Intersection, with two-way movements on each leg. This is confusing and creates multiple conflicts. The west leg has poor corner sight distance to the north, caused by an embankment. Church Street is only one lane wide in each direction. There are no left turn lanes for Church Street traffic, resulting in delays to through vehicles from left-turning vehicles awaiting gaps.

The poor geometrics create multiple conflicts within a small area. Drivers on all approaches are confronted with vehicles turning in front of them; with queues; and with a rapid succession of navigational and control tasks. These factors create a poor level of service throughout the day, and are directly responsible for the very high accident rate.

**DESIGN PRINCIPLES APPLIED TO ACHIEVE OPERATIONAL AND SAFETY OBJECTIVES**

The primary safety objective, reduction in accidents, can be achieved by limiting the number of conflict points and simplifying the conflict area. Combining the two overlapping T-intersections into one conventional intersection will accomplish this objective. It will also facilitate traffic control and improve level of service, thereby achieving a second objective. The following design principles are addressed in the re-designed intersections:

- **Reduction in conflict area and crossing conflicts at right angles** (Through traffic on both streets exposed to crossing conflicts)
- **Facilitation of high priority movements** (Through traffic on both streets)
- **Facilitation of Traffic Control** (Multi-way stop control or signal control is possible)
- **Separation of Points of Conflict** (Left turns from both streets)

**DESIGN CONSTRAINTS**

The church and embankment on the northwest corner of the intersection limit the ability to make geometric changes in this quadrant.

## SUMMARY OF DESIGN SOLUTION

(1) The east leg of Bernard Avenue is realigned to create a single-leg intersection.

(2) Separate left turn lanes are provided on approaches to minimize conflicts and delays caused by left turns.

(3) Right turns are channelized, with separate right turn lanes off Church Street in both directions.

(4) Painted islands are used to close up remaining open pavement area.

(5) The old east leg of Bernard Avenue is retained as a free right turn lane.

(6) Traffic signals are installed. (Note: the initial plans called for operation of this intersection with 4-way stop control.)



(a), (b) and (c) The through movement on Bernard Avenue is difficult to safely perform. Drivers must turn left from a stopped position (after contending with poor corner sight distance); turn right; and yield to other vehicles turning left from southbound Church Street. Crossing, rear-end and merging conflicts regularly occur for these "through" vehicles.



(d) The Y-type geometry at the eastleg of Bernard Avenue creates driver confusion and produces queues under even light traffic volumes. Note the worn out painted channelization and large, open pavement area.

(e) Through vehicles on Church Street must contend with multiple conflict points. Lack of channelization and the offset produce a large conflict area.

(f) The embankment in the northwest quadrant creates poor sight distance for Southbound Church Street as well as eastbound Bernard Avenue.

INTERSECTION NO. 12

U.S. Route 10 and Frazee Street  
 Detroit Lakes, Minnesota  
 (Submitted by Minnesota Department of  
 Transportation)

Urban Intersection with Route Turn

Prevailing Speeds on Approach Streets  
 -- 30 - 35 mph

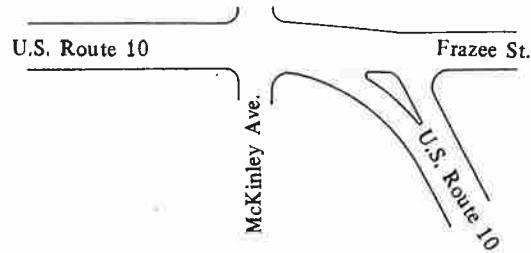
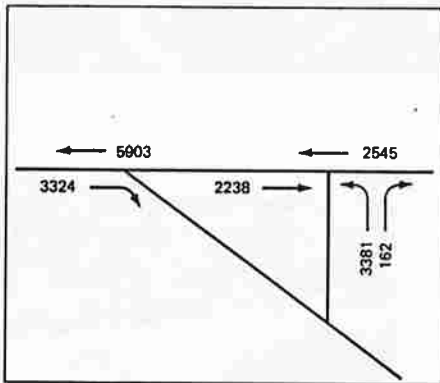
**TRAFFIC DATA****ACCIDENT EXPERIENCE**

(1976 - 1977)

Total Accidents	18
Fatal Accidents	0
Injury Accidents	5
Property Damage Only	13

**Accidents By Type**

Rear end	7
Sideswipe (Same Dir.)	2
Right Angle	4
Turning	3
Other/Unknown	2

**PRE-IMPROVEMENT OPERATIONAL CHARACTERISTICS**

U.S. Route 10 is a major, marked through arterial that passes through Detroit Lakes. Frazee Street is a minor city street with limited continuity. 1975 traffic counts showed ADT of 4300 for Frazee Street, and 7750 for U.S. Route 10. Frazee Street ends at U.S. Route 10, with all traffic proceeding to the east. The present configuration requires eastbound U.S. 10 traffic to stop, with preference given to Frazee Street traffic. Corner sight distance is poor, making this movement hazardous. Also, westbound U.S. 10 traffic proceeding onto Frazee Street (a "left" turn) conflicts with through U.S. 10 traffic in both directions. Half of the 18 accidents in 1975-1976 were directly related to difficulties in turning traffic.

Adjacent land use is commercial, and traffic/side friction from parked vehicles and a service station contribute to the operational and safety problems.

**DESIGN PRINCIPLES APPLIED TO ACHIEVE OPERATIONAL AND SAFETY OBJECTIVES**

Improvements to the safety and operational efficiency were focused on the inappropriate traffic control and travel patterns at the intersection. The primary problems, solved through channelization, concerned local street conflicts with through traffic. The following channelization principles are in evidence:

- **Prioritize and facilitate high priority movements**  
 (Through traffic using U.S. Route 10)
- **Remove decelerating and queued vehicles from through traffic**  
 (Left turns from westbound U.S. 10 to Frazee Street)
- **Prohibit undesirable movements**  
 (East to north movement from Frazee Street to U.S. Route 10 not allowed)

**SUMMARY OF DESIGN SOLUTION**

(1) U.S. Route 10 is realigned on a curve for both directions to achieve through continuity.

(2) The approach leg of Frazee Street is realigned to tee into U.S. Route 10. This approach is stop controlled, and eastbound U.S. Route 10 is no longer stopped.

(3) A left turn lane is added for westbound turning traffic on U.S. Route 10. This is accomplished within a median created by two large islands introduced on U.S. Route 10.

(4) A median island on Frazee Street separates opposing traffic, and channelizes all eastbound traffic into a right turn.

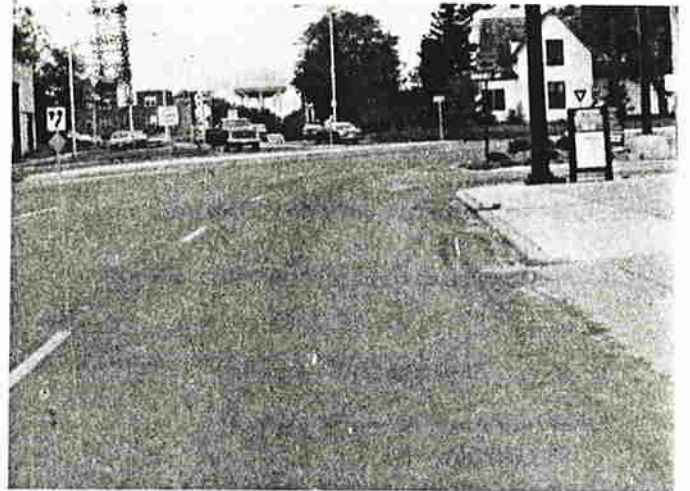

(a) Before construction, eastbound traffic on U.S. Route 10 encountered large open pavement, with no protection for vehicles bound for Frazee Street. The continuity of U.S. Route 10 is not clearly defined.



(b) Before construction, westbound U.S. Route 10 was forced to stop at Frazee Street.



(c) Design of the channelization provides protection for stopped vehicles, clearly defines the through route, and produces conflict angles of about 90°.



(d) After reconstruction, the through continuity is well defined. Storage for left turning vehicles improves both safety and efficiency of the through movement.



(e) After reconstruction, continuity for westbound traffic is established. Note the stopped vehicle on the Frazee Street approach.



(f) Sufficient storage exists to handle occasional periods of heavy left turn demand.

INTERSECTION NO. 13

1st Avenue North and Exposition Drive  
 Billings, Montana  
 (Submitted by Montana Department of Highways)

Urban Intersection with Capacity Problem

Prevailing Speeds on Approach Roads -- 40 mph

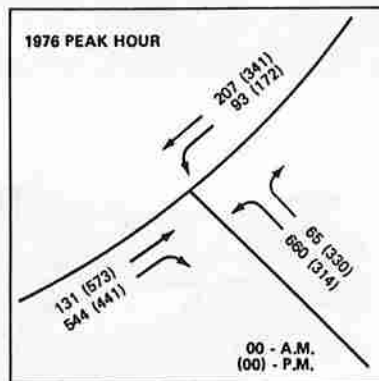
**TRAFFIC DATA****ACCIDENT EXPERIENCE**

(2 1/2 years)

Total Accidents 47  
 (predominantly rear-end  
 and angle accidents)

**PRE-IMPROVEMENT OPERATIONAL CHARACTERISTICS**

1st Avenue North is a four-lane primary arterial serving the downtown. Exposition Drive is also a major arterial that forms a T-type intersection with 1st Avenue North. The intersection operated under stop control, with certain major movements free-flowing. The westbound "through" and right-turn movements on 1st Avenue North were stopped, as was the left turn (eastbound) movement from Exposition Drive.

The intersection was within a major corridor being reconstructed. Severe capacity problems, demands for local access, and a corridor accident rate over twice the state average resulted in re-design. Expected future increases in traffic demand contributed to the final solution.

The unusual operation of the intersection and high traffic volumes resulted in a large number of angle and crossing accidents.

**DESIGN PRINCIPLES APPLIED TO ACHIEVE OPERATIONAL AND SAFETY OBJECTIVES**

Promotion of corridor capacity and treatment of the high accident rate were the principal objectives. Signalization of the intersection was an important requirement. Widening and channelization to facilitate high volume movements with minimal delay were necessary to optimize signal operations. The design principles listed below are embodied in the design solution.

- **Facilitation of high priority movements**  
 (Provision for free-flow movements and double turn lanes)
- **Crossing conflicts at right angles**  
 (Basic intersection geometry)
- **Separation of conflicts**  
 (Signalization provides time separation of crossing and turning conflicts)

## SUMMARY OF DESIGN SOLUTION

(1) Exposition Drive is widened to provide a four-lane approach from the north, with a double left turn to the east. The west to north through movement is widened to three lanes. From the east, a single right turn lane and double left turn lanes are provided.

(2) The right angle geometry is maintained, with raised median channelization.

(3) The intersection is signalized, with separate phases for all major turning movements.



(a) Auxiliary pavement markings and a wide throat assist the movement of the double left turn from the east leg.

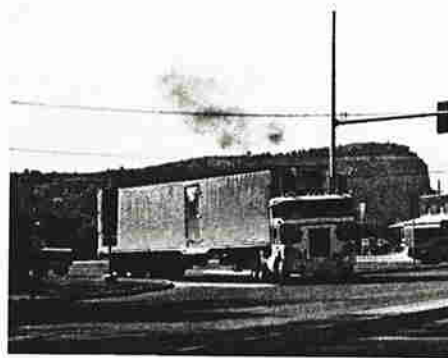

(b) All turning movements are designed to accommodate large semi-trailers.



(c) Advance signing is important at high-volume intersections with double turning lanes.



(d) Through traffic onto Exposition Drive proceeds on a smooth, flat horizontal curve. Note the blunt approach end of the "right" turn lane island nose.



(e) Turning lanes are long enough to assure independent queuing and operation.



(f) The 90° angle of intersection produces a compact intersection with small conflict areas. Note the small right corner radius, which discourages undesirable right turns.

INTERSECTION NO. 14

State Route 138 and State Route 85  
Clayton County, Georgia

(Submitted by Georgia Department of  
Transportation)

Suburban Intersection with Capacity Problem

Prevailing Speeds on Approach Roads -- 35 - 45 mph

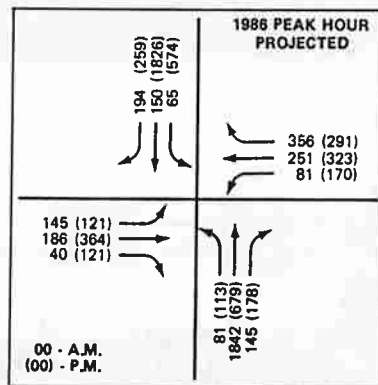
**TRAFFIC DATA****ACCIDENT EXPERIENCE**

(1979)

53 Accidents  
22 Injuries  
1 Fatality

**PRE-IMPROVEMENT OPERATIONAL CHARACTERISTICS**

This signalized intersection is surrounded by high trip-generating land use, including shopping centers, fast food restaurants and service stations. The intersection operates at a poor level of service throughout the day because of the restricted approach widths and lane arrangements on State Route 138. There are no separate left turn lanes, and only one through lane in each direction on Route 138. As a result, left turns impede the through movements and create queues. Vehicles accessing the surrounding land uses further aggravate the operation of the intersection.

The existing intersection is channelized to facilitate right turns from all quadrants. Triangular corner islands and separate right turn lanes are provided. The combination of these islands and the single through lane on Route 138 creates a narrow throat for vehicles turning left from Route 85.

All of the above geometric and operational problems have contributed to a poor accident record.

**DESIGN PRINCIPLES APPLIED TO ACHIEVE OPERATIONAL AND SAFETY OBJECTIVES**

The primary objectives were to increase the level of service of the intersection and improve the safety. The following channelization principles were considered as priorities:

- **Removal of decelerating and queued vehicles from through lanes**  
(Left turns from Route 138)
- **Facilitation of high priority movements**  
(Through traffic on both highways, and the heavy north to east turning movements)
- **Facilitation of traffic control schemes**  
(Ability to control the intersection with a range of signal phasing schemes)



## SUMMARY OF DESIGN SOLUTION

(1) State Route 138 is widened to provide two through lanes and a separate left turn lane in each direction.

(2) The southbound left turn lane on State Route 85 is widened to two lanes to facilitate this heavy turning movement. The opposing east to north right turn lane is retained.

(3) Two-way left turn lanes are provided on the approaches of State Route 138 to facilitate access to adjacent land use and minimize conflicts with through traffic.

(4) Traffic signal equipment is upgraded.



(a) and (b) Single lane approaches force the combination of through and left turning vehicles. Safety problems ensue in the form of frequent rear-end conflicts. This lane arrangement also seriously impacts intersection capacity. Signal operation alternatives are limited to separate phases for each approach (possibly very inefficient), or single phase operation, which results in substantial delays to through vehicles from queued left turners.

(c) Queuing along Route 138 affects access to nearby businesses. Large delays occur for vehicles leaving this shopping center. Other left-turning vehicles entering nearby businesses must queue in the through lanes, causing further delays to through vehicles.

Note the negative operational effect of the corner island, which prevents through vehicles from passing queued left turn vehicles.



(d) and (e) The existing left turn lane handles peak period traffic of over 500 vehicles per hour. This movement presently turns into a narrow throat defined by the opposing lanes and far-side corner island. Future operations require a second left turn lane and relocation of the corner island to provide minimum throat width.

(f) A free (yield-controlled) right turn lane presently serves the heavy east to north movement. The redesigned intersection retains a separate right turn lane.

INTERSECTION NO. 15

U.S. Route 3 and U.S. Route 202  
(Interstate 393 Connector)

Concord, New Hampshire

(Submitted by New Hampshire Department  
of Public Works and Highways)

Urban Intersection with Access Control Problem

Prevailing Speeds on Approach Streets -- 30 - 35 mph

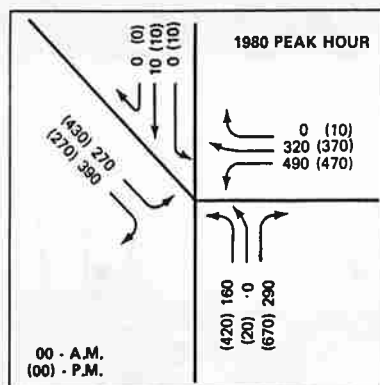
**TRAFFIC DATA****ACCIDENT EXPERIENCE**

(4 years)

26 Accidents

0 Fatalities

**PRE-IMPROVEMENT OPERATIONAL CHARACTERISTICS**

U.S. Route 3 (Bouton Street) is a major access route to downtown Concord from the north. U.S. Route 202 serves as a major access route from the east. Major turning movements occur at their Y-type intersection, which includes North Main Street, a local facility serving the historic district of Concord.

Major traffic demands were anticipated for the intersection due to the reconstruction of its eastern leg as a direct connection to a new Interstate highway.

**DESIGN PRINCIPLES APPLIED TO ACHIEVE OPERATIONAL AND SAFETY OBJECTIVES**

The objective in redesigning the intersection was to maximize the level of service within the existing right of way of Bouton Street and Main Street (U.S. Route 202 south leg). Priority was given to major through movements.

This involved removal of southbound movements from the north leg of North Main Street, and control of driveway access and other local street movements. The following channelization principles were applied:

- **Facilitation of high priority movements**  
(Major through and turning movements)
- **Prohibition of undesirable movements**  
(Local left turn access to properties at intersection and southbound movements from North Main Street.)
- **Facilitation of traffic control schemes**  
(Lane arrangements and movement prohibitions enable simple 3-phase signalization scheme.)

## SUMMARY OF DESIGN SOLUTION

New I-393 connector (east leg of U.S. Route 202) is widened, with a double left turn lane provided for the east to south movement.

(2) Southbound movements from North Main Street into the intersection were prohibited by closing off the lane and constructing a large cul-de-sac. Access was provided to the north, away from this intersection.

(3) Raised median channelization was provided on all legs for a minimum of 120 feet from the intersection. This prevented left turns to and from driveways at the intersection, and restricted movements to and from Church Street, a minor road intersecting with Bouton Street.

(4) New traffic signals and control equipment were installed.

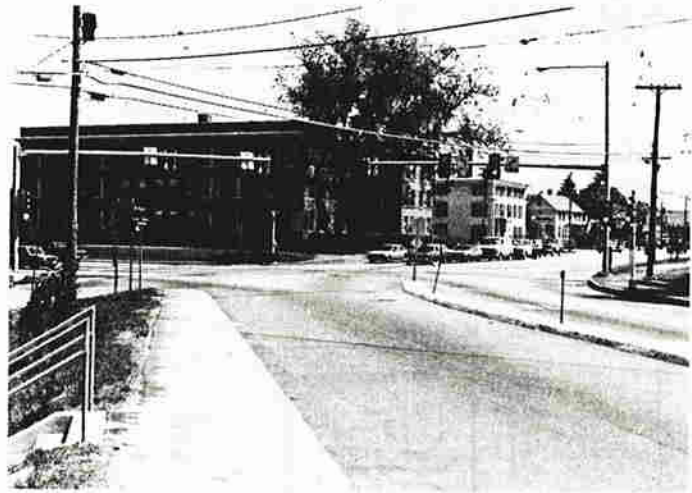

(a) Movements into the intersection from the north leg of North Main Street are eliminated by construction of a cul-de-sac. Movements out of the intersection are still allowed. (Access to this area is maintained one block to the north by another connection to Bouton Street.



(b) and (c) Raised median channelization acts as a barrier to left turn access to adjacent businesses and Church Street, a minor road just north of the intersection.



The raised channelization also provides a positive separation between opposing flows on all legs.

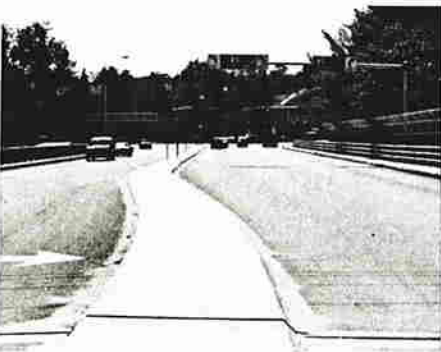

(d) and (e) The heavy east to south movement is handled by development of a double left turn lane on the I-393 connector. The advance overhead signing is particularly important, as the outside left turn lane is developed directly from a through lane. A throat width of 30 feet tapering to 28 feet is provided for turning vehicles in two lanes.



(f) The combination of lane markings, median channelization, overhead signing and signalhead placement produces a clear message to drivers about proper lane placement.

INTERSECTION NO. 16

63rd Street (State Route 10) and Mastin Street  
 Mastin Street  
 Merriam, Kansas  
 (Submitted by Kansas Department of Transportation)

Urban Intersection with Access Control Problem Area  
 (Commercial Strip Development)

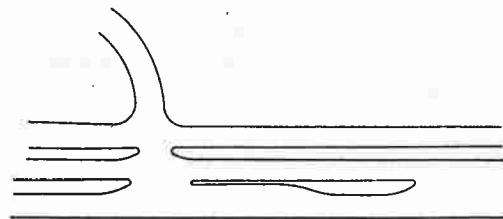

Prevailing Speeds on Approach Roads -- 40 - 45 mph (63rd Street)

**TRAFFIC DATA**

<b>1977 PEAK HOUR</b>	
13 (18) 65 (17) 1 (15)	2 (37) 2 (45) 1 (5)
5 (33) 1 (19) 1 (5)	4 (13) 18 (66) 0 (1)
00 - A.M. (00) - P.M.	16 (16) 57 (15)
11 (21) 1768 (1168)	11 (80) 384 (2021)

**ACCIDENT EXPERIENCE**  
 (22 Mos. -- 1976-1977)

Total Accidents	49
Fatal Accidents	0
Injury Accidents	12
Property Damage Only Accidents	12
<b>Accidents By Type</b>	
Angle/Turning	27
Rear end	14
Head on	1
Sideswipe	5
Other	2

**PRE-IMPROVEMENT OPERATIONAL CHARACTERISTICS**

63rd Street is a 4-lane divided arterial paralleled by a 2-lane frontage road, with a 12-foot separation between the roadways. The frontage road provides access to strip development, including many restaurants, stores and service stations. Mastin Street is a north-south collector terminating at 63rd Street. Southbound traffic is stop controlled at 63rd Street, with frontage traffic stopped at Mastin Street. 63rd Street operates without traffic control, with protected left turn storage provided at Mastin Street.

The high volumes and speeds on 63rd Street contributed to an unsafe intersection, as evidenced by the large number of angle accidents involving vehicles from Mastin Street.

**DESIGN PRINCIPLES APPLIED TO ACHIEVE OPERATIONAL AND SAFETY OBJECTIVES**

Improvement of the safety of the intersection was a major objective. Because of the close proximity of the frontage road, a combination of channelization and traffic control measures was required. The following design principles apply:

- **Separation of points of conflict** (Separating frontage road from 63rd Street)
- **Facilitation of high priority movements** (Signalization scheme)
- **Prohibition of undesirable movements**  
 (Closure of adjacent access to 63rd Street, with diversion of traffic to signalized intersection)
- **Merging of traffic streams at flat angles**  
 (Design of left turn acceleration lane from Mastin Street to eastbound 63rd Street)
- **Elimination of conflicts** (Crossing/turning conflicts removed by signal)

## SUMMARY OF DESIGN SOLUTION

Fully actuated traffic signals were installed at 63rd Street.

(2) Left turn channelization to 63rd Street was designed to function as a merge, thereby enabling eastbound 63rd Street to maintain continuous flow.

(3) The frontage road intersection with Mastin Street was relocated about 55 feet to the north. This separated the stop-controlled frontage road intersection from the signal, and provided storage on Mastin Street for vehicles queued to access 63rd Street.

(4) A median opening about 350 feet west of Mastin Street for access to the frontage road was closed. This diverted traffic to the safer, signalized access at Mastin Street.

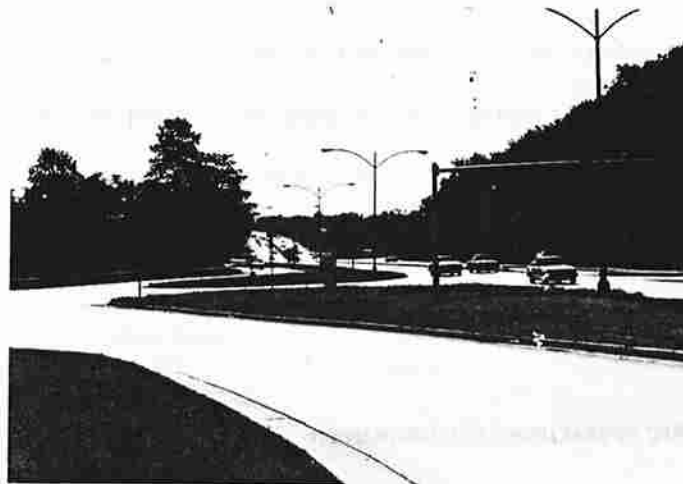

(a) The frontage road is relocated away from 63rd Street to provide separation between frontage Road/Mastin Street conflicts and the 63rd Street signalized intersection. Storage for about 3 passenger cars is created.



(b) The "normal" frontage road/Mastin Street cross section is shown here. Note the land use along the frontage road.



(c) Adjacent access to 63rd Street is closed, with vehicles re-routed to the Mastin Street signalized intersection.



(d) The left turn lane to Mastin Street is contained within the raised median. The channelization allows for unstopped eastbound movements along 63rd Street.



(e) Left turns from Mastin Street must merge with the through (unstopped) eastbound traffic.



(f) Westbound 63rd Street traffic is controlled with the new traffic signal.

INTERSECTION NO. 17

State Highway Route 135 and Main Street  
Lafe, Arkansas

(Submitted by Arkansas State Highway and Transportation Department)

Rural Intersection Reconstruction for Large Vehicles

Prevailing Speed on Approach Roads -- 40 mph

**TRAFFIC OPERATIONAL REQUIREMENTS**

Main Street intersects under stop control with State Highway 135. The original skewed intersection was inadequate for large trucks. Narrow approach widths, severe skew, and tight corner radii created extreme difficulties.

The redesigned intersection was to continue under stop control, with no significant changes to approach widths or lane arrangements. Facilitation of large truck turning movements was the primary design consideration.

**DESIGN CONSTRAINTS**

Redesign was confined to the area immediate to the intersection. Removal of the skew angle and widening of approach widths was not possible.

**SUMMARY OF DESIGN SOLUTION**

- 1) Additional surfacing was provided along State Highway 135 opposite Main Street. The extra pavement is utilized by large trucks turning left from Main Street.
- 2) Additional surfacing was provided along Main Street to provide a wide right turn lane for west to south movements.
- 3) The "throat" of westbound Main Street was significantly widened to accept both left and right-turning trucks from State Highways 135.
- 4) Because of width requirements for trucks, the intersection area was greatly increased. To prevent wandering of vehicles, provide positive guidance, and place stop and other regulatory signs, raised median and corner islands were installed.



Scale 1" = 50'

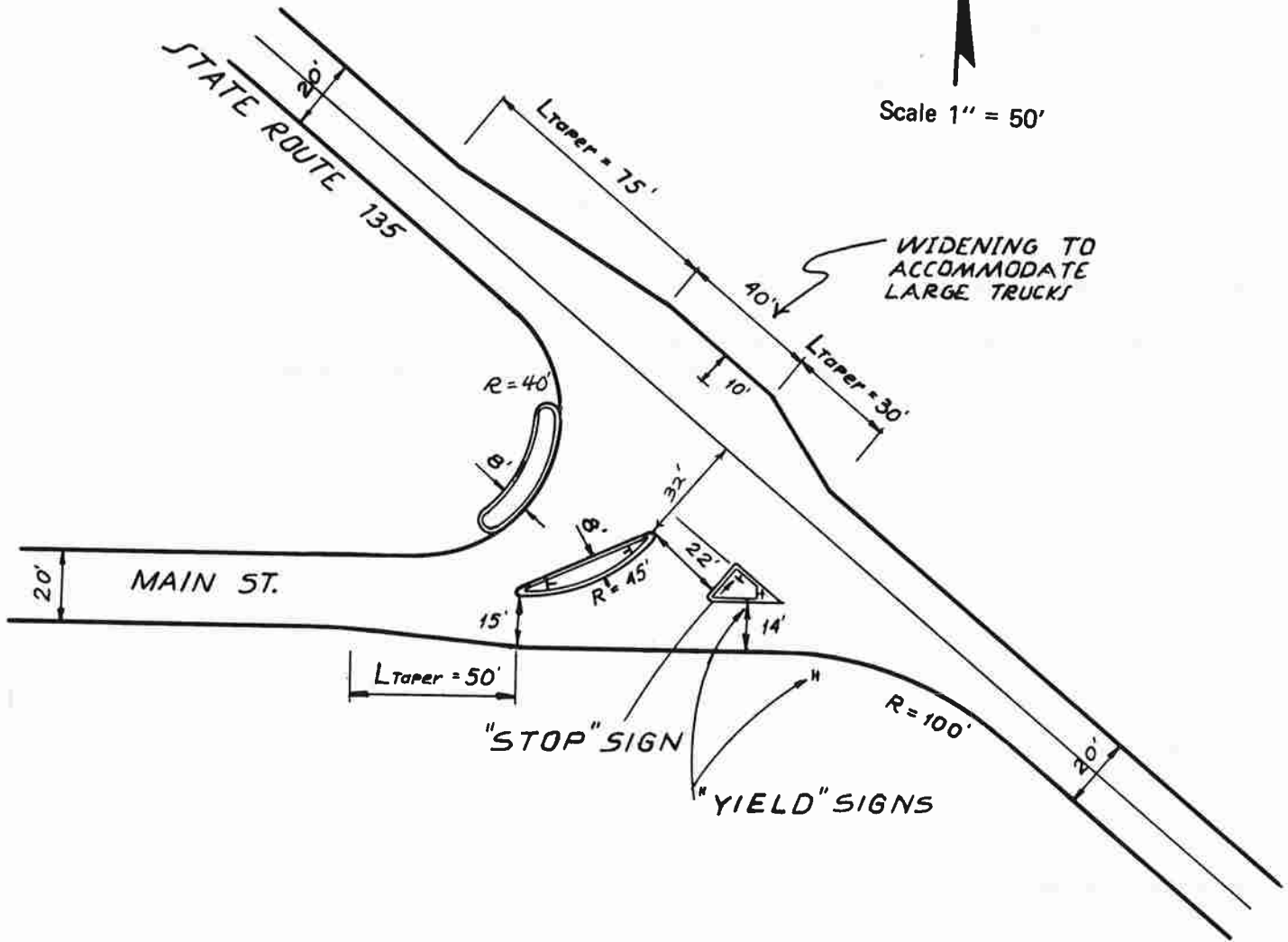

**CONSTRUCTION COST DATA**

Estimated Cost of Construction \$12,000

Intersection No. 17

**STATE ROUTE 135 AND MAIN STREET**

Lafe County, Arkansas

Submitted By:

*Arkansas State Highway and  
Transportation Department*

**INTERSECTION NO. 18**

State Route 17 and Ramps to Interstate Highway 74  
Henry County, Illinois  
(Submitted by Illinois Department of Transportation)

Rural Intersection Reconstruction for Large Vehicles

Prevailing Speeds on Approach Roads -- 50 mph

**TRAFFIC OPERATIONAL REQUIREMENTS**

Increases in allowable truck sizes necessitate design revisions to certain intersections. Illinois DOT policy is to adopt the WB-60 design vehicle for design of Interstate and other designated highways. To allow for access to the Interstate system, ramp terminal intersections must accommodate this design vehicle.

**DESIGN CONSTRAINTS**

Spot improvement of existing ramp terminal intersections should be performed at a minimal cost, due to the large number of intersections requiring treatment. Provision for WB-60 turning movements must therefore be made without basic changes to the intersection form.

**SUMMARY OF DESIGN SOLUTION**

- 1) The right turn radius from Ramp B is increased from the existing 180-65-180 three-centered curve to a 200-75-200 three-centered curve. This revision allows for the larger turning radius, and also opens up the turning roadway.
- 2) The nose radius design between Ramps A and B is altered to provide a wider throat for vehicles turning into Ramp A from the left turn lane on State Route 17.
- 3) The median nose radius on Route 17 is relocated approximately 18 feet to the west, and a longer taper is provided to accommodate vehicles turning left from Ramp B.
- 4) The right turn radius from Route 17 to Ramp A is increased from the existing 150-50-150 three-centered curve to a 180-70-180 three-centered curve.





Scale 1" = 50'

# STATE ROUTE 17

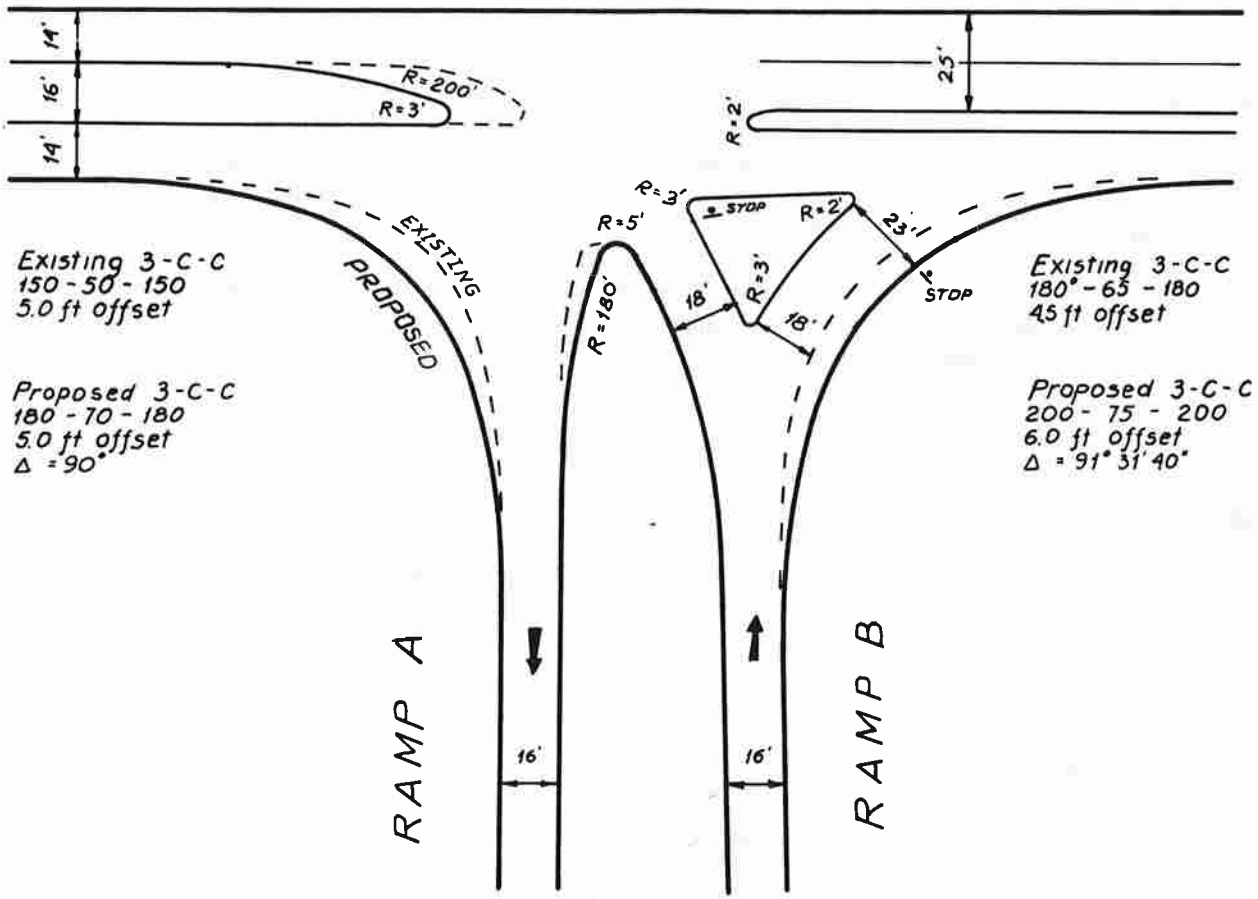

Intersection No. 18

### CONSTRUCTION COST DATA

Estimated Cost of Construction \$35,000

**STATE ROUTE 17 AND RAMP TO  
 INTERSTATE HIGHWAY 74**

Henry County, Illinois

Submitted By:

*Illinois Department of Transportation*

INTERSECTION NO. 19

Maine Street and 4th Street  
Quincy, Illinois

(Submitted by Illinois Department of Transportation

Urban Intersection Designed for Large Trucks

Prevailing Speeds on Approach Streets -- 25-30 mph

**TRAFFIC OPERATIONAL REQUIREMENTS**

4th Street is a 4-lane, one-way arterial that intersects with Maine Street in the central business district. The intersection is signal controlled. Raised median channelization is used on the south leg to separate opposing traffic.

Frequent, large trucks turn to and from 4th Street. The tight corner radii and existing channelization make turning movements difficult for such trucks. Design modifications were proposed to facilitate these movements, within the existing constraints.

**DESIGN CONSTRAINTS**

The surrounding land use prohibited taking of additional right-of-way. This prevented consideration of increasing corner radii.

**SUMMARY OF DESIGN SOLUTION**

- 1) The median channelization was modified to accommodate south to east right turns.
- 2) The south approach was widened 2 feet each side, and a new corner radius of 20 feet was provided.
- 3) Traffic signals in the southeast corner were removed to provide more clearance.
- 4) The corner island was reduced slightly to provide additional width for east to north right turns.

The design modifications are sufficient to allow a WB-50 to turn right from Fourth Street from the right lane. Because the intersection is signal controlled, trucks can use the entire eastbound width to complete the turn without adversely affecting other movements.

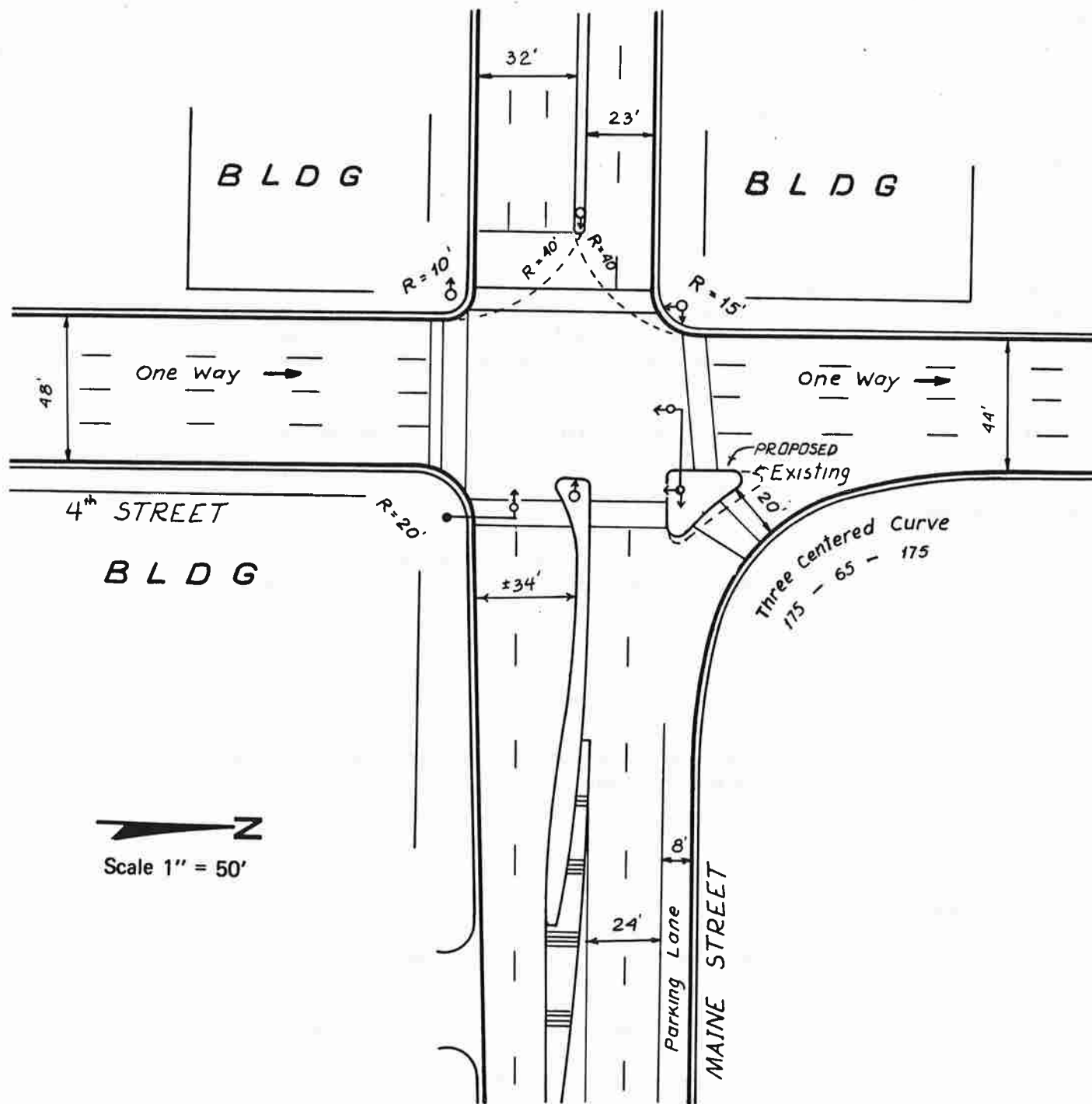

  
Scale 1" = 50'

Intersection No. 19

**MAINE STREET AND 4TH AVENUE**  
Quincy, Illinois  
Submitted By:  
*Illinois Department of Transportation*

INTERSECTION NO. 20A

Spokane Avenue and Second Street  
Whitefish, Montana  
(Submitted by Montana Department of Highways)

Urban Intersection Re-designed for Large Trucks

**TRAFFIC OPERATIONAL REQUIREMENTS**

The intersection of Spokane Avenue and Second Street experiences unusual operational problems due to the presence of frequent oversize semi-trailers. U.S. Route 93 makes a turn at this intersection. A large number of eight axle trucks hauling wood chips regularly follow Route 93 through Whitefish. These vehicles have an overall length of 74 feet, and a minimum turning radius of 55 feet.

Trucks of all types represent 5 to 7 percent of total traffic (over 12-hour peak period).

The existing intersection is typical of downtown treatments, with small radius curb returns, on-street parking, and built-up adjacent right of way.

The steady increase in the use of these large vehicles required an immediate redesign of the intersection. Because of existing constraints, a two-phase improvement plan was developed.

**DESIGN CONSTRAINTS**

New right of way is extremely limited and expensive to acquire. Any improvements to corner radius geometry or the cross section were therefore constrained.

**SUMMARY OF DESIGN SOLUTION (INITIAL PHASE)**

- 1) The southwest curb return was reconstructed, with an offset (truncated) larger radius curve.
- 2) Parking on the east side of Spokane and north side of Second Streets was removed.
- 3) Also, restriping and realignment of lanes on the south and west approaches to the intersection was implemented. Skip striping was proposed to guide all turning traffic.
- 4) Adjustments were made to the locations of traffic signals and utilities in the southwest corner of the intersection.

These improvements were intended to allow trucks to swing wide and complete a west-to-south right turn without encroaching on parked vehicles or opposing lanes of traffic.



Scale 1" = 50'

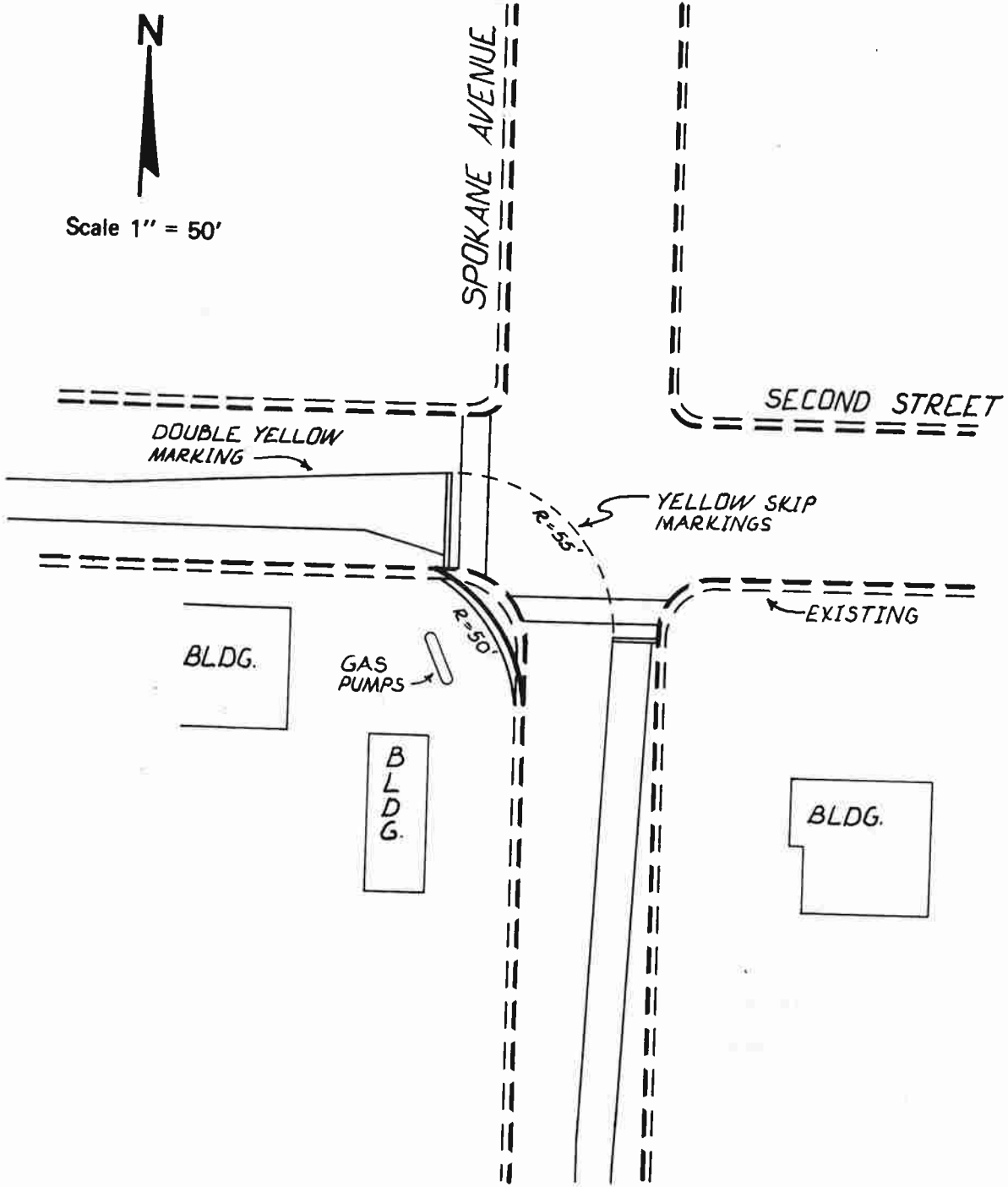

Intersection No. 20a

SPOKANE AVENUE AND SECOND STREET  
(U.S. ROUTE 93)  
Whitefish, Montana  
Submitted By:  
Montana Department of Transportation

INTERSECTION NO. 20B

Spokane Avenue and Second Street  
Whitefish, Montana  
(Submitted by Montana Department of Highways)

Urban Intersection Re-designed for Large Trucks

**SUMMARY OF DESIGN SOLUTION (ULTIMATE)**

An ultimate solution, to be implemented when right of way at the existing service station becomes available, is shown at right at 50 scale. This design solution includes:

- (1) Reconstruction of the southwest curb return with compound curvature
- (2) Reconstruction of the pavement within the intersection
- (3) Adjustments to the locations of traffic signals and utilities

This solution is intended to allow the oversize trucks to perform a right turn within half the roadway on each street. Implementation will enable a return to the previous, normal striping and lane arrangements. In addition, adequate corner clearance to private access will be incorporated in the final design.

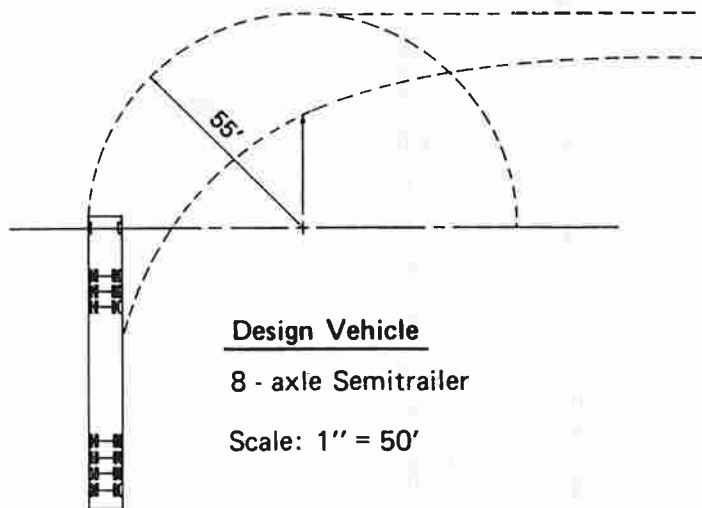

The design vehicle path for both interim and ultimate design is shown above.



Scale: 1" = 50'

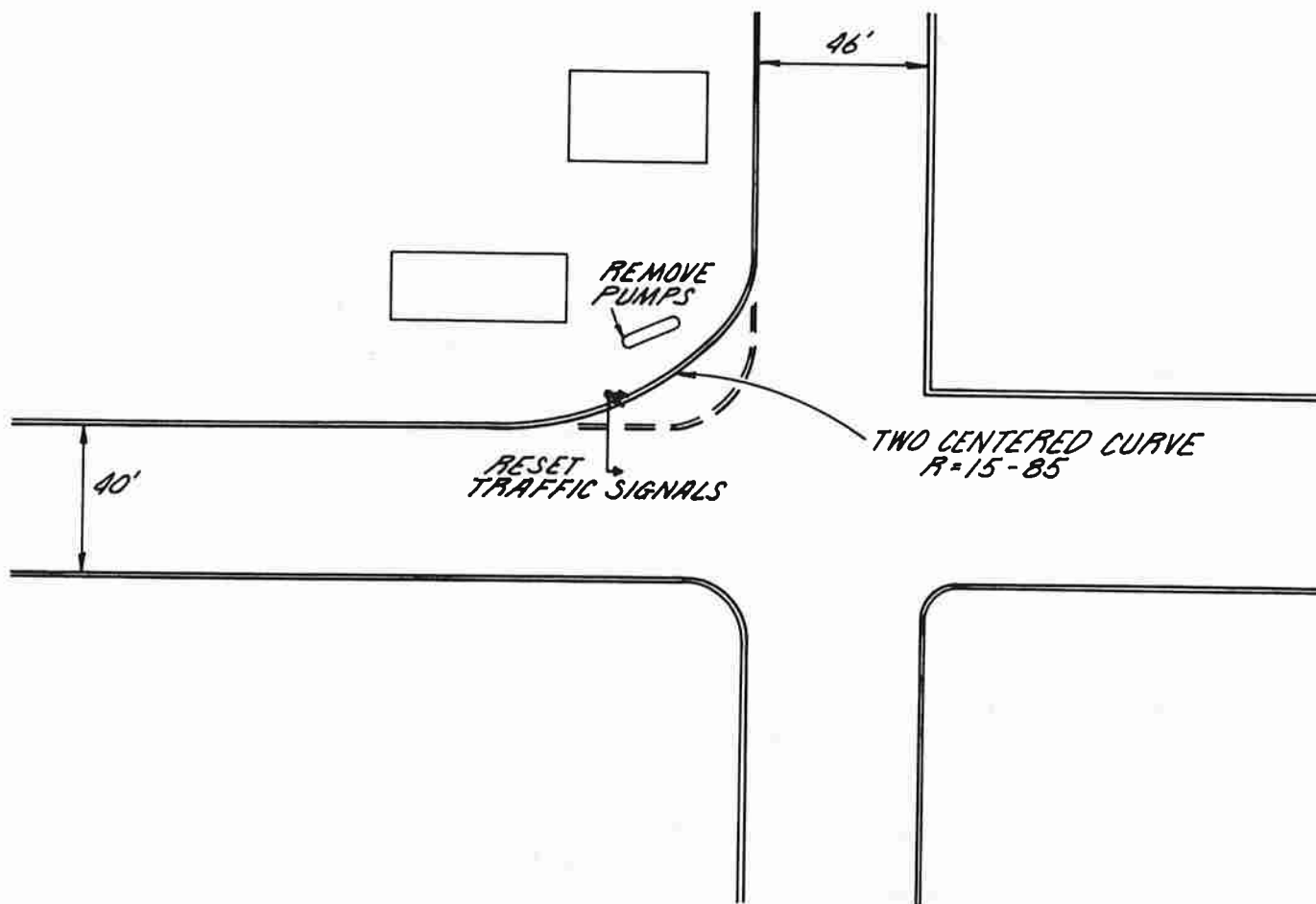

**ULTIMATE SOLUTION:**  
New "two-centered curve" enables return to conventional pavement markings and operation

Intersection No. 20b

SPOKANE AVENUE AND SECOND STREET  
(U.S. ROUTE 93)  
Whitefish, Montana  
Submitted By:  
Montana Department of Highways

**INTERSECTION NO. 21**

Schrock Road and Huntley Road  
Worthington, Ohio  
(Submitted by Ohio Department of Transportation)

Suburban Intersection Design to Accommodate Bicycle Lanes

Prevailing Speeds on Approach Streets -- 35 - 40 mph

**TRAFFIC OPERATIONAL REQUIREMENTS**

The design of Schrock Road provides for 5-foot one-way bikeways in each direction of traffic. Huntley Road is a collector. Its intersection with Schrock Road requires signalization and provision for exclusive left and right turn lanes.

Safe accommodation of bicycle traffic within the capacity and other operational constraints was an important requirement.

Projected use of the bicycle lanes included a large number of children.

**SUMMARY OF DESIGN SOLUTION**

The bikeways were transitioned to outside the edge of pavement prior to the intersection. This helps reduce the chances of sideswipe conflicts with right turning vehicles. It also facilitates safe storage outside the intersection for bicyclists awaiting a green signal indication.

The placement of the bikeway and crosswalks encourage left turn bicycle movements to cross Schrock Road rather than use the left turn lanes. Note the placement of pedestrian/bicycle signal indications adjacent to the bikeway.



Photographs courtesy of Ohio Department of Transportation





Scale 1" = 50'

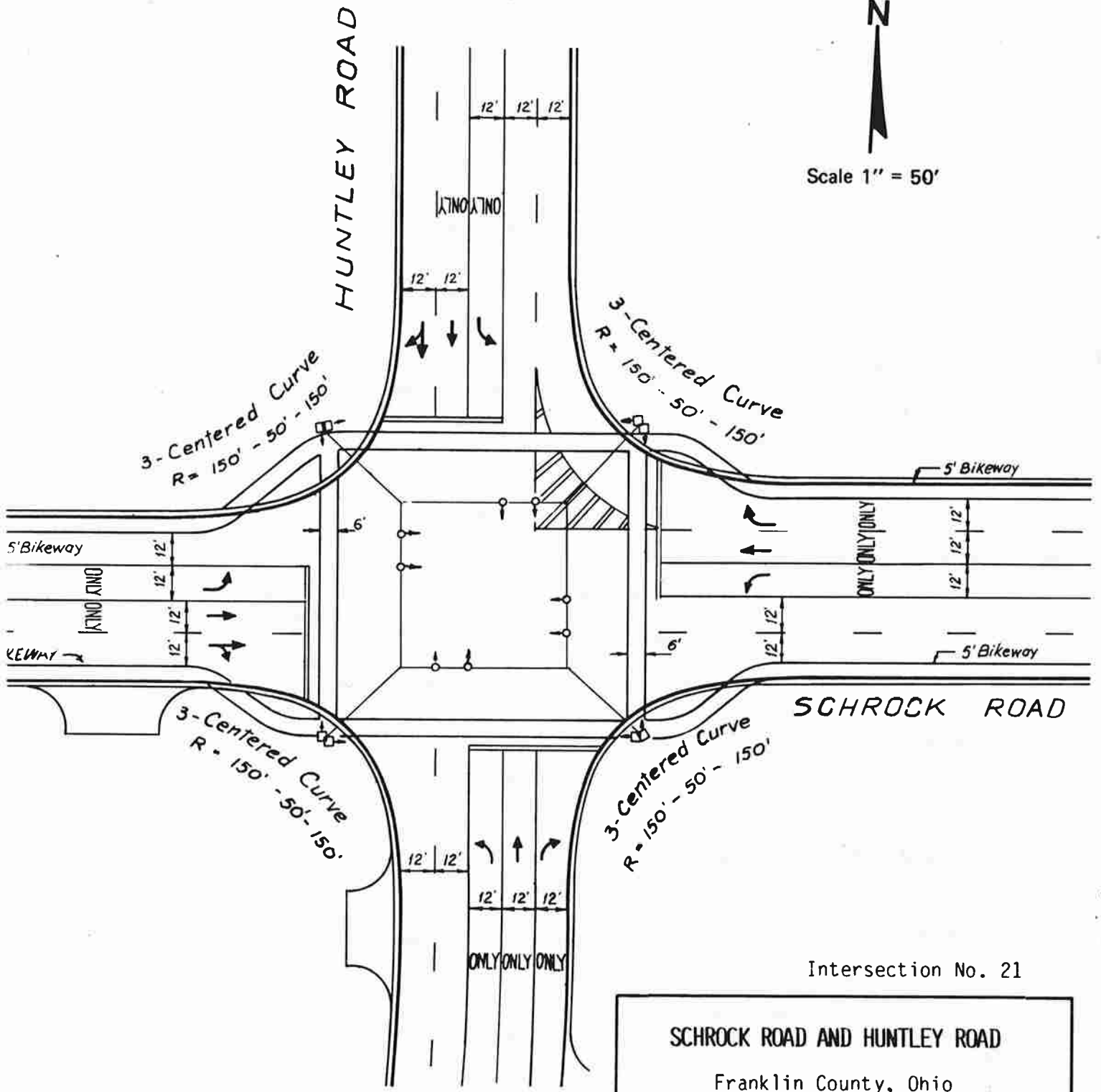

Intersection No. 21

SCHROCK ROAD AND HUNTLEY ROAD  
Franklin County, Ohio  
Submitted By:  
Ohio Department of Transportation

INTERSECTION NO. 22

U.S. Route 41 and Delany Road  
 Lake County, Illinois  
 (Submitted by Lake County Highway Department)

Suburban with High Volume Turns

Prevailing Speeds on Approach Roads -- 40 - 55 mph

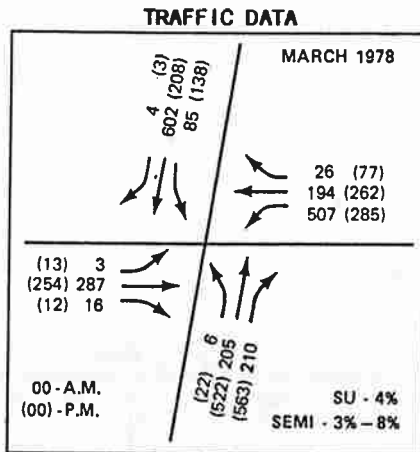
**ACCIDENT EXPERIENCE**

(2 Years Before)

Fatal Accidents	0
Injury Accidents	15
Property Damage Only	29

**Accidents By Type:**

Rear end	17
Angle	20
Head on	2
Sideswipe	1
Single Vehicle	4

**PRE-IMPROVEMENT OPERATIONAL CHARACTERISTICS**

This intersection of a major rural arterial serves a community with substantial industrial land use. The predominant traffic movements are through along U.S. 41 and north-to-east. As traffic demand on Delany Road increased, the north-to-east left turning traffic resulted in high delays and a low level of service. A significant percentage of this traffic is comprised of large vehicles (semi-trailers and single unit trucks). This intersection of a signalized, high-speed arterial experienced a large number of angle and rear-end accidents prior to its re-design.

**DESIGN PRINCIPLES APPLIED TO ACHIEVE OPERATIONAL AND SAFETY OBJECTIVES**

The primary objectives were to (1) improve the level of service of the heavy turning volumes; and (2) improve the safety of the intersection by limiting left-turn conflict frequency and severity, and by improving the heavy right-turn conflict severity. The following design principles apply:

- **Facilitation of high priority movements**  
 (North to east turning movements and through movements on U.S. Route 41)
- **Separation of decelerating or stopped vehicles from high speed through traffic**  
 (Provision for left turn lanes off Delany Road, and right turn lane off U.S. Route 41)
- **Facilitation of traffic control scheme**  
 (Provision for and design of turning lanes enabled adoption of optimal signal control)

**DESIGN CONSTRAINTS**

All turning movements were designed for a WB-50 design vehicle due to the functional classification of the major facility and the number of large vehicles using the intersection.

Local opposition limited the availability of right-of-way to the south, restricting the design to one through lane south of U.S. 41. The intersection re-design was part of an improvement to Delany Road to a five lane cross section.

## SUMMARY OF DESIGN SOLUTION

(1) Double left turn lanes at Delany Road provide sufficient storage and capacity to accommodate this heavy movement.

(2) A left turn lane was added to north Delany Road to project this movement and facilitate signal phasing.

(3) The right turn lane off westbound U.S. 41 was improved at the intersection. A larger turning radius and wide turning lane improve turning speeds, enable merging of turns at a flatter angle, and accommodate large trucks.

(4) North to South through movement is assisted by painted channelization.



(a) and (b) Pavement markings and overhead signing are provided well in advance of the intersection to alert approaching drivers.

(c) Large radius and wide throat provide for good operation of double left.



(d) and (e) Right turn roadway width and radius design enable easy turns by frequent semi-trailers.



(f) Pavement markings assist through vehicles.

INTERSECTION NO. 23

State Route 178 and Oak Street  
 Bakersfield, California  
 (Submitted by California Department  
 of Transportation)

Urban/Suburban Intersection with Right Turn  
 Accident Problem

Prevailing Speeds on Approach Streets -- 35 - 45 mph

**TRAFFIC DATA**

Total Entering Traffic  
 (1979 ADT)

29,500 vehicles per day

**ACCIDENT EXPERIENCE**

(3 Years)

Total Accidents 54

Fatal Accidents 0

Injury Accidents 15

Property Damage Only  
 Accidents 39

Accidents By Type

Rear end 44

Other Multivehicle 7

Single Vehicle 3

Total Accident Rate 1.25 per MEV

**PRE-IMPROVEMENT OPERATIONAL CHARACTERISTICS**

State Route 178 is a major east-west arterial serving Bakersfield, California. The signalized intersection with Oak Street is typical in its geometrics and operations with other California intersections. The original design provided for "free" right turn channelization onto and off Route 178. The right turning traffic operates independently of the signal control, with a merge required. Also, left turn storage is provided on Route 178 to facilitate operations.

This scheme operated adequately until traffic increased on both facilities. Increased traffic resulted in insufficient left turn lane storage, creating queuing in through lanes and rear-end conflicts between through and left turning vehicles. In addition, the free right turns no longer functioned, as vehicles were unable to merge into the heavy flowing through traffic. Again, rear-end conflicts and accidents resulted.

**DESIGN PRINCIPLES APPLIED TO ACHIEVE OPERATIONAL AND SAFETY OBJECTIVES**

There are two basic objectives in redesigning this intersection -- reducing rear-end conflict/accident frequency, and increasing overall intersection capacity. These are both achieved by enhancing the positive separation of conflicts at the intersection. The following design principles apply:

- **Separation of conflicts**

(Using the traffic signal and revised geometry to separate right turns from through traffic)

- **Removal of decelerating or stopped vehicles from through lanes**

(Increasing left turn storage capacity)

- **Facilitation of high priority movements**

(Increasing left turn storage capacity and eliminating merging right turns)

### SUMMARY OF DESIGN SOLUTION

(1) Right turn radii onto and off State Route 178 are reduced to 35 feet, with large islands removed.

(2) Left turn storage on State Route 178 is more than doubled by lengthening the turn bay and creating a double left turn.



(a) Prior to redesign, the intersection channelization scheme emphasized free right turn movements to and from Oak Street.



(b) The short left-turn lane from State Route 178 was frequently blocked by queues.



(c) The re-designed intersection scheme emphasizes treatment of left turns rather than right turns.

Photos (a) and (b) (Before) and (c) (After) are courtesy of California Department of Transportation

INTERSECTION NO. 24

Old McHenry Road (County Highway 32)  
and Quentin Road (County Highway 5)  
Lake County, Illinois  
(Submitted by Lake County Highway  
Department)

Rural T-type Intersection Designed for Low Volume Left Turns

Prevailing Speeds on Approach Roads -- 45

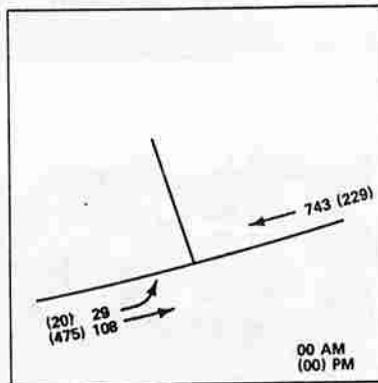
**TRAFFIC DATA****ACCIDENT EXPERIENCE**

(2 Years)

Total Accidents	15
Fatal Accidents	0
Injury Accidents	8
Property Damage Only Accidents	7
Accidents By Type	
Rear-end	2
Angle	4
Sideswipe	2
Single Vehicle	8

**PRE-IMPROVEMENT OPERATIONAL CHARACTERISTICS**

The existing t-type intersection of Quentin Road with Old McHenry Road contained no approach geometrics or special turning lanes. Quentin Road was stop-controlled.

The County Highway Department conducted a study of their 260-mile system. This intersection was identified for improvement because of the relatively high traffic volumes on Old McHenry Road. Efficiency and safety in providing for turning traffic as well as the high volume through traffic was central to development of a solution.

**DESIGN PRINCIPLES APPLIED TO ACHIEVE OPERATIONAL AND SAFETY OBJECTIVES**

The intersection is characterized by high through volumes along Old McHenry Road (the east-west facility), and moderate or light turning movements. The operational objective is to handle efficiently both predominant movements, as well as other lesser movements. The following principles apply:

- **Facilitation of high priority movements**  
(Through traffic and right turns from Old McHenry Road)
- **Separation of points of conflict**  
(Turning movements off Old McHenry Road)

**DESIGN CONSTRAINTS**

The agency's limited budget required development of an inexpensive interim solution. No additional right-of-way was taken for the implemented design.

## SUMMARY OF DESIGN SOLUTION

(1) A separate right turn lane from Old McHenry Road eastbound was provided to separate heavy right turns from through traffic.

(2) A by-pass lane was constructed for westbound Old McHenry Road traffic. This lane is for use by through vehicles encountering the occasional left turn traffic. When no left turning vehicles are present, westbound through traffic continues within the through lane.

(3) The by-pass lane is considered a cost-effective solution because of the relatively low left turn volumes and hence low frequency of use. Its construction requirements are considerably less than the alternative, a shadowed left turn deceleration lane. It is anticipated that a conventional left turn lane will eventually be constructed.



(a), (b) and (c) The bypass lane for westbound traffic begins about 300 feet in advance of the intersection. It is intended for optional use by through drivers who encounter queued left turning vehicles in the left lane. The bypass lane merges back into the through lane past the intersection.



(d) and (e) An exclusive right turn lane provides for safe deceleration for the heavy right turn volume from Old McHenry Road. Clear sight lines to the cross road are evident from the photo at right.

(f) The stopped approach on Quentin Road is separated from opposing volumes by a painted island.

INTERSECTION NO. 29

New York - Albany Post Road (U.S. Route 9)  
Wappinger Falls to Poughkeepsie  
Dutchess County, New York  
(Submitted by New York Department of Transportation)

Suburban Highway Reconstructed with Special  
Left Turn Design for Control of Access

Prevailing Speeds on Approach Roads -- 40 - 45 mph

**TRAFFIC OPERATIONAL REQUIREMENTS**

This major, four-lane arterial is being upgraded because of capacity and safety deficiencies. Current problems largely relate to left turning traffic at intersections and into adjacent strip commercial development. In the future, increased through traffic and further development of adjacent property are expected. Balancing the need to provide corridor capacity with demands for access is a major operational problem to be solved.

**DESIGN CONSTRAINTS**

Design year traffic on the corridor ranges from 42,000 to 54,000 ADT. Right-of-way limitations restrict the roadway cross section to five lanes plus shoulders.

Severe drainage problems require closed drainage throughout the corridor, with curb and gutter on the outside edges of shoulders.

**SUMMARY OF DESIGN SOLUTION**

- 1) Raised median channelization was provided to positively control left turn access.  
(Continuous two-way left turn lane was considered but not applied.)
- 2) Left turn lanes were incorporated at all signalized intersections.
- 3) Jug-handle turns (see design at right) were designed to accommodate left turn access demands between signalized intersections. The jug handles are spaced about 700 feet from the major intersection, with maximum spacing between permitted left turns in each direction of less than 0.5 miles.
- 4) Full shoulders were included to increase the corridor capacity by reducing right turn side friction.



Scale 1" = 50'

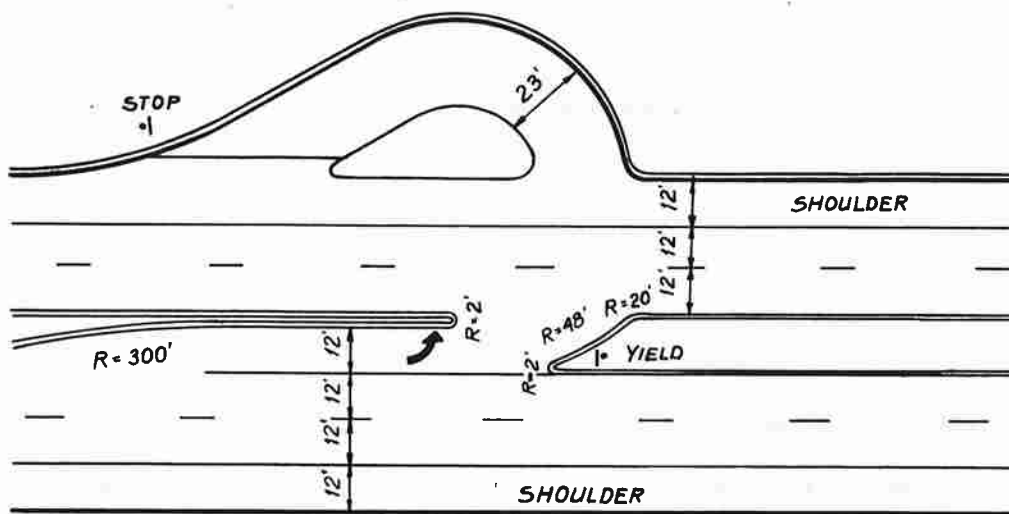

$L_{Taper} = 120'$      $L_{Turn Lane} = 60'$

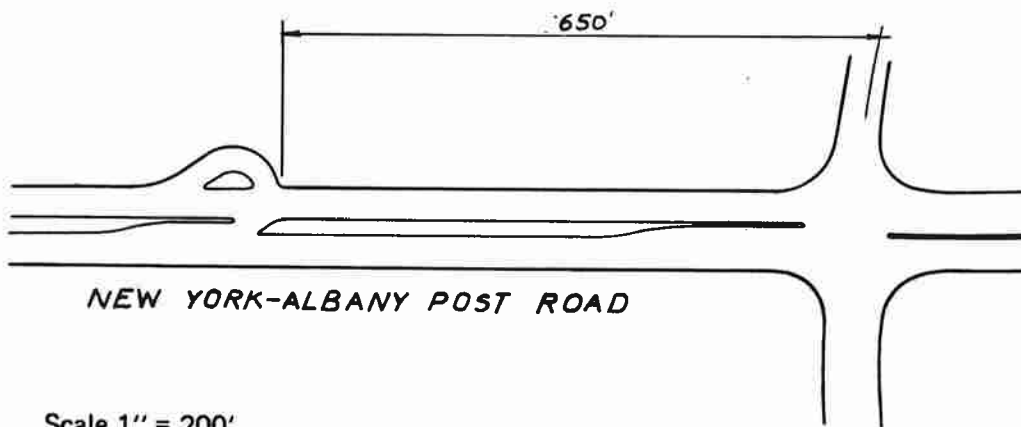

Scale 1" = 200'

Intersection No. 29

**NEW YORK - ALBANY POST ROAD**  
**(U.S. ROUTE 9)**

Dutchess County, New York

Submitted By:

*New York Department of Transportation*

INTERSECTION NO. 30

Seaway Drive (U.S. Route 31--Business) and  
Seminole Avenue  
Norton Shores, Michigan  
(Submitted by Michigan Department of Transportation)

Suburban Intersection with Special (Crossover)  
Left Turn Lane Design

Prevailing Speeds on Approach Roads -- 40 - 45 mph

**TRAFFIC OPERATIONAL REQUIREMENTS**

Seaway Drive is a major, four-lane divided arterial with a 60-foot median. The primary operational objective is to maintain a high intersection and corridor level of service. Design and operation of the intersection thus reflect an emphasis on providing green time for through traffic on Seaway Drive.

**SUMMARY OF DESIGN SOLUTION**

The design solution adopted by the Michigan Department of Transportation is typical of other similar situations in the intersection. Left turning vehicles proceed through, and use a far-side median crossover to access the cross street. This design/operational treatment enables the use of simple two-phase signalization, which is optimal for corridor signal progression schemes. The wide median provides sufficient room for trucks to turn at the crossover. The crossovers in this case are placed about 450 feet on each side of the intersection.

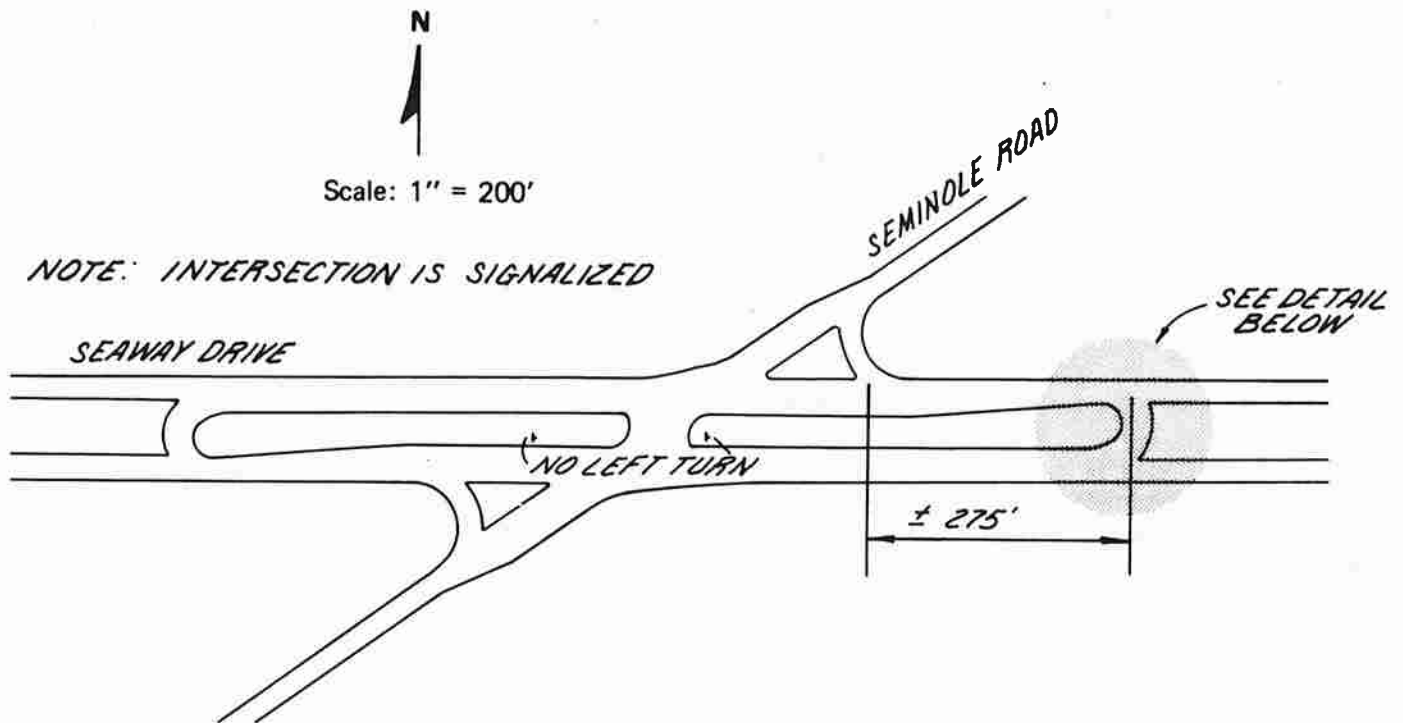

DETAIL: SCALE 1" = 50'

ONE WAY

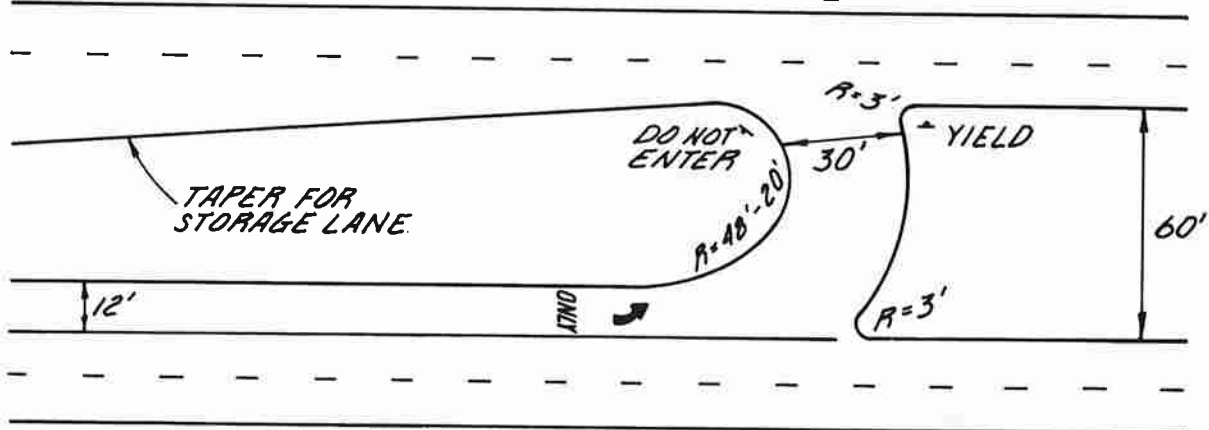

Intersection No. 30

"Left turns" store on approach to the intersection. Vehicles proceed through (turn prohibited) and use u-turn channelization and right turn lane to complete the movement.

SEAWAY DRIVE (U.S. ROUTE 31 - BUSINESS)  
AND SEMINOLE AVENUE

Norton Shores, Michigan

Submitted By:

Michigan Department of Transportation

INTERSECTION NO. 31

Falls of the Neuse Road (Secondary Road 2000)  
Raleigh, North Carolina

(Submitted by North Carolina Department of Transportation)

Example Application of Two-way Left Turn Lanes

**OPERATIONAL AND GEOMETRIC CHARACTERISTICS OF TWLTL**

Falls of the Neuse Road is a major arterial highway serving commercial and residential areas on the outskirts of Raleigh. The TWLTL is used here by drivers accessing local residential streets, private driveways, and small businesses. The posted speed limit is 45 mph, and 1983 Average Daily Traffic is 12,500. This design utilizes full lane widths for all 5 lanes.

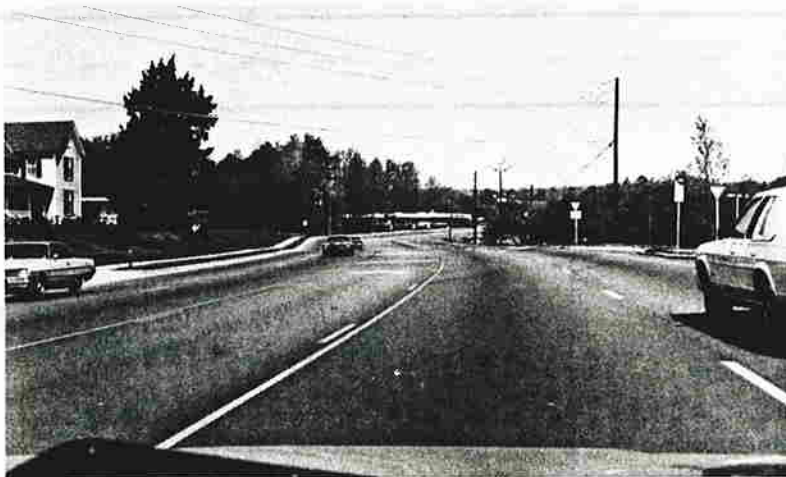
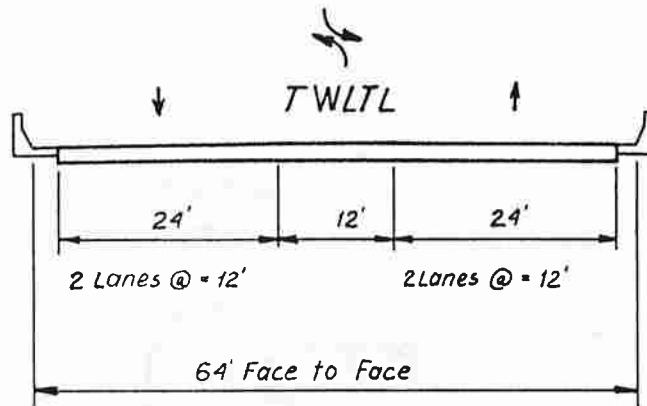

INTERSECTION NO. 32

Wolf Road  
Albany, New York

(Submitted by New York Department of Transportation)

Example Application of Two-way Left Turn Lanes

**OPERATIONAL AND GEOMETRIC CHARACTERISTICS OF TWLTL**

New York uses a 3/8 in white asphalt overlay to provide a flush, long lasting positive form of delineation for their continuous two-way left turn lanes. Wolf Road is a major, high volume arterial serving shopping centers, fast food restaurants and other commercial land uses. A 16-foot TWLTL is used here.



INTERSECTION NO. 33

Western Avenue (U.S. Route 20)  
Albany, New York

(Submitted by New York Department of Transportation)

Example Application of Two-way Left Turn Lanes

**OPERATIONAL AND GEOMETRIC CHARACTERISTICS OF TWLTL**

Western Avenue is a major arterial with mixed light commercial and residential adjacent land use. Note the introduction of left turn lanes at the signalized intersection. Also note the use of 4-foot bicycle lanes in each direction of traffic.



INTERSECTIONS 34 THROUGH 37—CASE STUDIES IN RECONSTRUCTION OR REHABILITATION OF INTERSECTIONS

The remaining intersections (34 through 37) embody special case studies that show the application of channelization principles to solve an existing operational or safety problem. In each case, cost, right-of-way, or other constraints had to be recognized and included in the formulation of the solution.

**Intersection 34** (Roswell/Piedmont/Blackland Roads, Atlanta, Georgia), a focal point of north/south access into the city, experienced serious capacity problems. The multileg character, extremely high distributional peaking of traffic, and local access conflicts created the problems. Right-of-way constraints precluded major widening. However, a workable set of design and channelization solutions was developed. The solution included closure of a leg, construction of a bypass collector to remove some traffic from the intersection, rechannelization of the intersection with multiple turning lanes, and an area-wide traffic control system. The key feature of this case is the combination of geometric, control, and channelization elements that comprised the solution.

**Intersection 35** (U.S. Route 1 and 1A, Franklin County, North Carolina), a rural intersection, in its pre-reconstructed state is typical of many overchannelized designs found nationwide. They are characterized by multiple islands, many path choices, and unclear right-of-way or prioritization of movements. The operational characteristics of such intersections tend to create problems under moderate to high traffic volumes.

The solution shown represents a good illustration of a

principle that most engineers espouse. Channelization should be simple and direct. Designers should use conventional means of achieving solutions to assure compatibility with driver expectations. Simple designs are more readily understood, less costly to construct, and easier to maintain.

**Intersection 36** (Mission Street and Westlake Avenue, Daly City, California) illustrates the importance of considering pedestrian safety in intersection design and operation. In this example, a wide, moderate-speed arterial carrying substantial through traffic imposes difficulties on pedestrians attempting to cross it. Signalization and median channelization solved the problem. Also, the type of channelization and traffic control assured minimal impacts on the flow of through traffic.

**Intersection 37** (Broadway/Clinton/South Street, Concord,<sup>4</sup>New Hampshire) is an excellent example of the application of simple channelization to achieve significant improvement in operations. The keys were to close up and simplify the multileg intersection, control access in the immediate vicinity, and provide lane arrangements and signalization that accommodate the major movements.

INTERSECTION NO. 34 -- CASE STUDY IN RECONSTRUCTION

Roswell Road (U.S. Route 19/State Route 9),  
 Piedmont Road (State Route 237),  
 Blackland Road and Old Ivy Road  
 Atlanta, Georgia  
 (Submitted by Georgia Department of Transportation)

Urban Multi-leg Intersection with High Turning  
 and Through Traffic Volumes

Prevailing Speeds on Approach Streets -- 30 - 35 mph

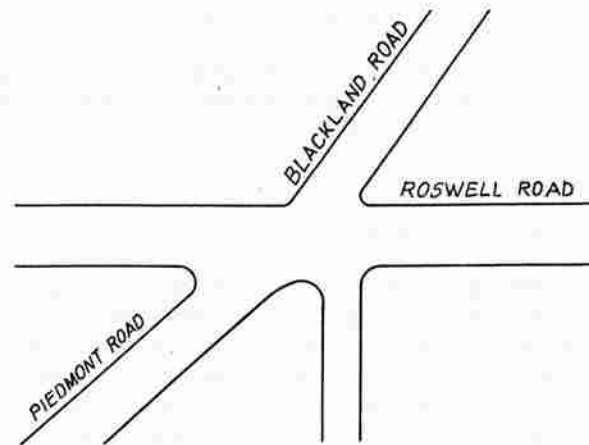
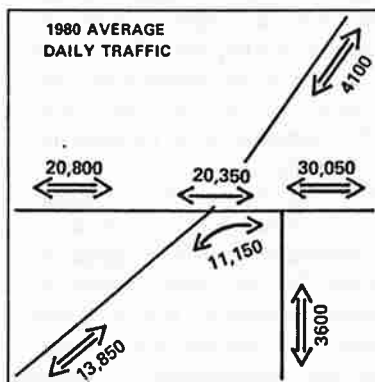
**TRAFFIC DATA****ACCIDENT EXPERIENCE**

(1970)

Total Accidents	11
Injury Accidents	3
Property Damage Only	8
Total Accident Rate	0.90 per MEV

**Accidents By Type**

Right Angle	8
Other	3

**PRE-IMPROVEMENT OPERATIONAL CHARACTERISTICS**

This major intersection was a principal bottleneck for traffic in north Atlanta. Roswell Road and Piedmont Road are two of the three primary arterials accessing the downtown from the north. Their convergence creates heavy demands on the intersection, with high volume turns, heavy peak hour flows, and extreme directional distribution of traffic.

Further compounding the capacity problems are the convergence of Blackland Road and Old Ivy Roads within the intersection. This effectively creates a five-leg intersection which necessitated multiple signal phasing. In addition, other nearby intersections and high volume driveways to businesses along Piedmont and Roswell Roads further contributed to traffic congestion.

**DESIGN PRINCIPLES APPLIED TO ACHIEVE OPERATIONAL AND SAFETY OBJECTIVES**

Increasing the capacity of the intersection and its major approaches was the principal objective. This entailed special consideration of the unusual traffic characteristics (i.e., turns, directional peaking) and treatment of the confounding geometrics of the location

The objective was achieved by implementation of system solutions such as widening of approaches, route closures and new street construction; and by reallocation of approach lanes combined with new signalization schemes. The following channelization principles were applied:

- **Facilitation of high priority movements**  
 (Major turning movements from Piedmont Road to Roswell Road)
- **Prohibition of undesirable movements**  
 (Closure of Old Ivy Road to eliminate the fifth leg of the intersection)
- **Facilitation of traffic control schemes**  
 (Relocation of Old Ivy Road and establishment of coordinated signal system for the entire area)



## SUMMARY OF DESIGN SOLUTION

(1) The south leg of Roswell Road was widened to 66 feet to provide room for two through lanes in each direction and a double left lane to Piedmont Road.

(2) Piedmont Road was widened to 60 feet to provide for a 5-lane section, with 3 lanes into the intersection northbound. This approach was marked for two right turn lanes and one through lane, with left turns prohibited.

(3) Existing Old Ivy Road was closed at the intersection. A new extension to Habersham Road was built to connect with Old Ivy Road east of the intersection, providing a means of rerouting local traffic away from the Piedmont/Roswell intersection.

(4) Traffic signals were installed at Roswell Road and Habersham Road; and at Piedmont Road and Habersham Road. These signals were coordinated with the operation of the Piedmont/Roswell intersection.

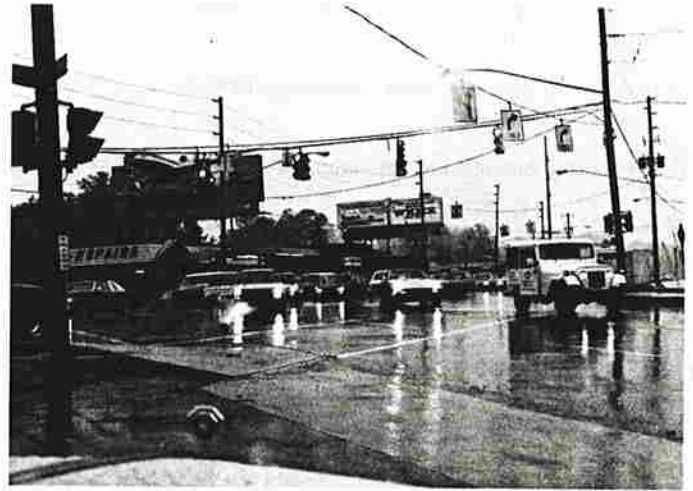

(a) and (b) The heavy southbound movement from Roswell Road to Piedmont Road is served by a double left turn lane. Limited availability of width requires the use of 10-foot lanes, and a throat width of 26 feet. The shallow angle of turn partially mitigates the adverse operations of these minimal dimensions.

(c) The return movement (Piedmont to Roswell) is handled with a double right turn. No left turns are allowed on this approach, as they can be easily accommodated just to the south at Habersham Road.



(d) The northbound approach on Roswell Road is widened. The left turn lane is offset from the through lanes with painted chevron channelization.

(e) The normal cross section along Roswell Road to the north includes a continuous two-way left turn lane. Note the concentration of commercial driveways on both sides of the road.

(f) A new roadway (Habersham Road) acts as a diverter/circulation roadway to remove traffic from the major intersection.

INTERSECTION NO. 35 - CASE STUDY IN RECONSTRUCTION

U.S. Route 1 and U.S. Route 1A  
Franklin County, North Carolina  
(Submitted by North Carolina Department  
of Transportation)

Rural Intersection with Inappropriate  
Channelization

Prevailing Speeds on Approach Roads -- 40 - 50 mph

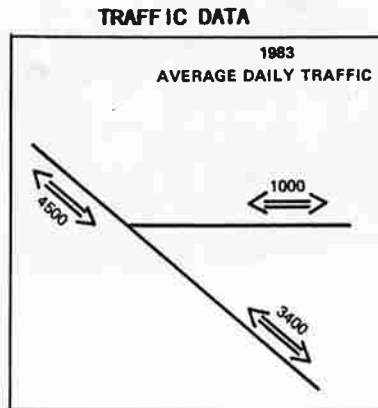
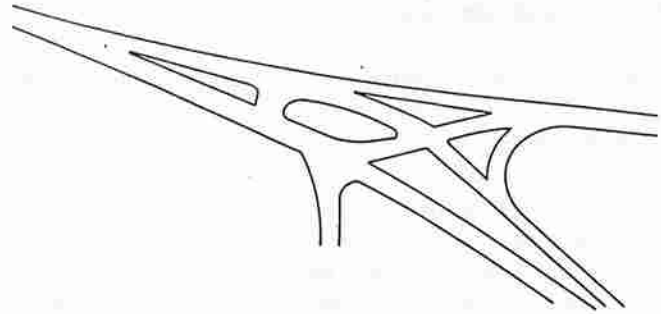
**ACCIDENT EXPERIENCE**

(3 Years)

Total Accidents -- 11

**PRE-IMPROVEMENT OPERATIONAL CHARACTERISTICS**

The Intersection of U.S. Routes 1 and 1A north of Raleigh, North Carolina is typical of many older intersections of primary highways in rural areas. The two routes intersect at about a 45° angle, with five very large grassed islands placed to define desirable vehicle paths. Paths that cross or merge are controlled with stop and yield signs. The original intent of such designs was to provide as high a level of service for all intersection movements. This was achieved by large radii for high speed turns, made possible by spreading the intersection across a large area.

While the intersection functioned adequately for many years, its inherent operational deficiencies surfaced as traffic volumes increased. Such increases led to greater probabilities of actual vehicle/vehicle conflicts. This necessitated a reexamination of the intersection's safety and operational priorities, with particular attention to principles of driver expectancy.

The original intersection does not clearly prioritize the various movements. By facilitating all turns in a similar manner, the old design in effect equalizes all movements. This results in a great potential for severe crossing conflicts. In addition, rear-end conflicts between turning and through vehicles are not sufficiently treated.

**DESIGN PRINCIPLES APPLIED TO ACHIEVE OPERATIONAL AND SAFETY OBJECTIVES**

The primary design objective was to improve the safety of the intersection through complete rechannelization of the intersection. The following design principles were applied:

- **Facilitation of high priority movements**  
(Redesign of all approaches to clearly priority for U.S. Route 1)
- **Removal of decelerating or stopped vehicles from higher-speed traffic lanes**  
(Left turn lanes provided off U.S. Route 1, and a right turn lane to U.S. Route 1A)
- **Controlling of speeds**  
(Design of radii and turn lanes to promote safe, low speed turns)
- **Cross Traffic Streams at Right Angles** (Reduction in severe skew)
- **Separation of Points of Conflict**  
(Turning lanes of sufficient length separate rear-end conflicts in advance of the intersection's crossing conflicts)

## SUMMARY OF DESIGN SOLUTION

(1) The entire intersection is "closed up," with the large islands removed.

(2) U.S. Route 1A is intersected with U.S. Route 1A at about 80°, thereby partially treating the severe skew.

(3) Left turn lanes are provided on Route 1, and a right turn lane is provided from Route 1 to Route 1A.

(4) All channelization is accomplished with paint rather than raised islands, with one exception. The southwest corner includes a traffic island, which is required because of the right turn lane and turning radius.

(5) A minor road, Secondary Road 1204, is incorporated within the intersection directly opposite Route 1A.

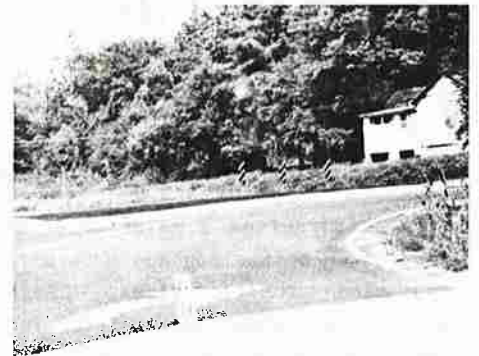
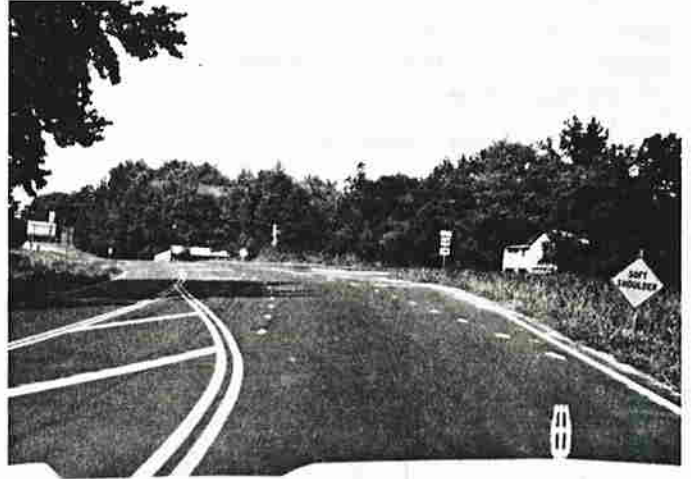

(a) and (b) Fully shadowed left turn lanes are provided with painted approach tapers. The long approaches give good advance notice of the intersection past the mild horizontal curve.

(c) The right turn lane turns into a 20-foot wide turning roadway defined by a depressed corner island. Note the full 10-foot offset of the corner island.

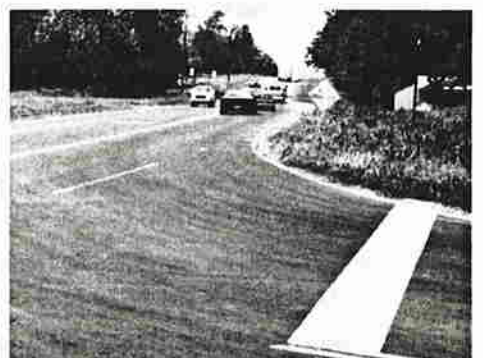

(d) The more compact, conventional intersection form provides clear sight lines, small conflict areas, and understandable operation for all drivers.

(e) The U.S. Route 1A approach leg is realigned to create an angle of intersection closer to 90°.

(f) Right turns from U.S. Route 1A are aided by an 80-foot radius return.

INTERSECTION NO. 36

Mission Street (State Route 82) and  
Westlake Avenue  
Daly City, California  
(Submitted by California Department  
of Transportation)

Urban Area (Light Commercial)

Prevailing Speeds -- 30 - 40 mph

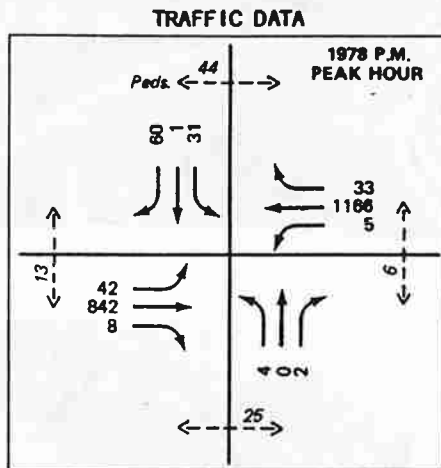
**ACCIDENT EXPERIENCE**

(4 Years)

8 Accidents  
7 Injuries  
1 Fatality

**ACCIDENTS BY TYPE**

Pedestrian Involved 2  
Angle 3  
Rear end/Sideswipe 3

**PRE-IMPROVEMENT OPERATIONAL CHARACTERISTICS**

Mission Street is a major arterial traversing Daly City. It provides 6 lanes of traffic, with parking on both sides and a 6-foot median. Westlake Avenue is a 2-lane residential street carrying minor traffic flows. Adjacent land use includes light commercial and residential. Significant pedestrian traffic, including senior citizens and school children, is generated by a nearby elementary school, a high school, and a community center on the northwest corner of the intersection.

The intersection, which is controlled by stop signs on both approaches of Westlake Avenue, is considered hazardous to pedestrians and vehicles attempting to cross Mission Street. Increases in traffic on Westlake Avenue are anticipated due to nearby improvements. Recent pedestrian-related accidents and complaints from local citizens led to study of the intersection.

**DESIGN PRINCIPLES APPLIED TO ACHIEVE OPERATIONAL AND SAFETY OBJECTIVES**

The primary objective, to enhance the safety of the intersection for all users, was accomplished through basic changes in the traffic control scheme. Conversion from stop to signal control required development of a new channelization plan. The new plan emphasized treatment of left turning and side street conflicts to minimize potential adverse safety and operational effects. The following design principles apply:

- **Removal of decelerating or stopped vehicles from higher-speed traffic lanes**  
(addition of left turn lanes on both approaches of Mission Street)
- **Provision for pedestrian refuge**  
(signalization and raised median channelization)
- **Prohibition of undesirable movements**  
(movements from cross streets near the intersection)
- **Facilitation of traffic control schemes**  
(Optimize signal phasing by use of left turn lanes)

**DESIGN CONSTRAINTS**

Maintenance of on-street parking on both sides of Mission Street was required.

**SUMMARY OF DESIGN SOLUTION**

- 1) Traffic signals, with pedestrian actuation, were installed.
- 2) Mission Street was reduced to 2 through lanes in each direction, with on-street parking maintained.
- 3) Raised median channelization (18 feet) was introduced to provide protection for new left turn lanes on both approaches of Mission Street.
- 4) The median channelization also prevents left turn access to Gambetta Street from Mission Street, thereby eliminating potential adverse crossing conflicts with traffic at the signalized intersection.
- 5) Left turn channelization is also provided at Como Avenue, just to the north of Westlake Avenue. This is needed to accommodate increased left- and U-turn traffic resulting from closure of the Gambetta Street median opening.



(a) The new median fully protects the left turn lane on the northbound approach to the intersection. Note the use of raised pavement markers, which are common to California.



(b) The roadway transitions from a narrow to an 18-foot median. This 18-foot dimension is adequate for full-width left turn lanes, and protection/refuge for pedestrians at the intersection.



(c) The pedestrian crosswalk features a median cut for wheelchairs.



(d) Exclusive u-turn channelization just north of Como Avenue serves southbound traffic from Gambetta and Como.



(e) The widened median necessitates merging of three through lanes into two. Large pavement arrows assist in the transition.



(f) Left turn access at Gambetta Street is eliminated through extension of the raised median.

INTERSECTION NO. 37 -- CASE STUDY IN RECONSTRUCTION

Broadway-Clinton Street (State Route 13)  
and South Street  
Concord, New Hampshire  
(Submitted by New Hampshire Department  
of Public Works and Highways)

Urban Multileg Intersection with Severe  
Operational and Safety Problems

Prevailing Speeds on Approach Streets -- 30 mph

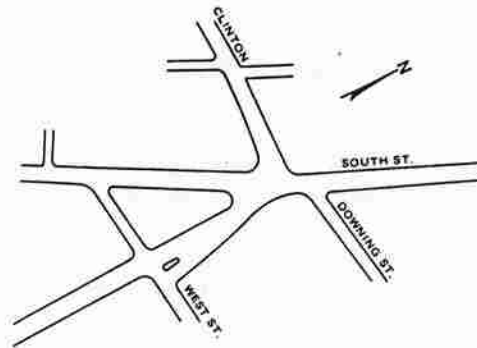
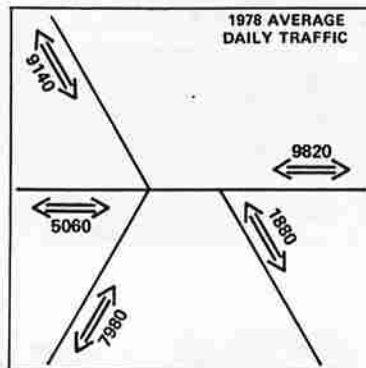
**TRAFFIC DATA****ACCIDENT EXPERIENCE**

(3 Years)

Total Accidents	29
Fatal Accidents	0
Injury Accidents	5 (7 Injuries)
Property Damage Only	24

**Accidents By Type**

Angle/Turning	20
Single Vehicle	4
Pedestrian/Bicycle	1
Rear end	2
Head on	1
Other	1

**PRE-IMPROVEMENT OPERATIONAL CHARACTERISTICS**

This multi-leg intersection of minor arterials and local streets requires reconstruction because of its poor operational and safety characteristics.

The convergence of South Street, a major route to downtown Concord, Broadway, Clinton and Downing Streets and these streets at a range of skew angles, results in an extremely large intersection. Channelization is minimal, and vehicles proceeding through the intersection wander cross the open area. Turning movements are difficult because of the multiple crossing conflict points and the large exposure area. Significant delays to CBD-bound vehicles following State Route 13, which proceeds from South Street to Clinton Street, occur throughout the day. The difficulty of such turns is evidenced by the large number of right angle and turning related accidents over three years.

Further compounding the problem is the large number of business driveways near the intersection. Side friction and turning conflicts with vehicles accessing these businesses is a major concern.

**DESIGN PRINCIPLES APPLIED TO ACHIEVE OPERATIONAL AND SAFETY OBJECTIVES**

A combination of significant reconstruction and signalization is necessary to improve both intersection operations and safety. In particular, turning movements from Broadway and Clinton Streets, and other minor street and driveway movements are to be addressed. The proposed plan reflects a number of important channelization principles:

- **Definition of vehicular paths**  
(Closing up open pavement area and providing positive channelization)
- **Separation of points of conflict**  
(Redesign separates a fifth leg from the intersection)
- **Crossing at right angles**  
(A right-angle crossing eliminates approach skew angles)
- **Facilitation of traffic control schemes**  
(Construction of conventional 4-leg intersection with turning lanes enables range of signal phasing schemes)
- **Prohibition of undesirable movements**  
(Control of access to eliminate driveway conflicts)

**SUMMARY OF DESIGN SOLUTION**

(1) A new intersection is to be constructed slightly south of the existing intersection. A convenience store/service station will be taken to provide the necessary right of way. The new intersection will be a conventional, 4-leg signalized intersection.

(2) Separation from Downing Street and elimination of left turn access at Downing Street remove conflicts from this former fifth leg.

(3) Separate turning lanes and signal phases for each approach will maximize the intersection's operational flexibility.

(4) Raised median channelization on all approaches will eliminate left turn driveway conflicts near the intersection.



(a) This view along Broadway looking north to South Street shows the open expanse of pavement of the existing intersection.



(b) Cross traffic from West Street and businesses along Broadway add conflicts to the intersection and complicate the driving task.



(c) The triangular traffic island in the middle of the intersection serves no channelization function.



(d) Heavy turning volumes from Broadway to South Street, Broadway to Clinton Street and Clinton Street to South Street create many opportunities for angle, sideswipe and rear-end accidents.



(e) The Clinton Street to South Street left turn operates at a poor level of service throughout the day. This heavy left turn operates under stop control, which creates substantial queues and long delays.



(f) The proposed design will eliminate this wide open intersection, and better define all traffic movements.





Intersection No. 1

U.S. ROUTE 65 AND STATE ROUTE 175

Hardin County, Iowa

Submitted By:

Iowa Department of Transportation

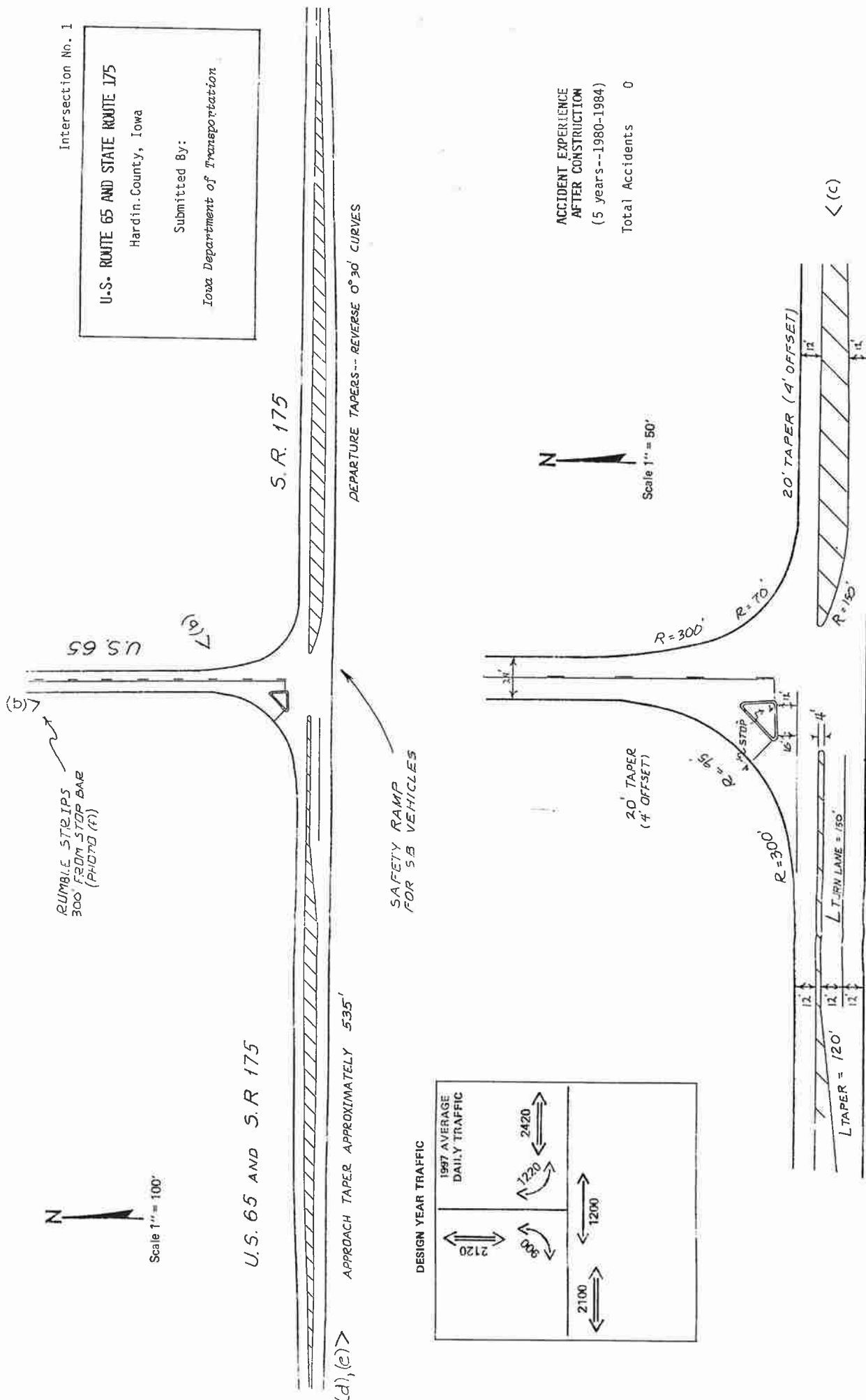

U.S. 65 AND S.R. 175

S.R. 175

APPROACH TAPER APPROXIMATELY 535'

DEPARTURE TAPERS-- REVERSE 0° 30' CURVES

SAFETY RAMP FOR SB VEHICLES

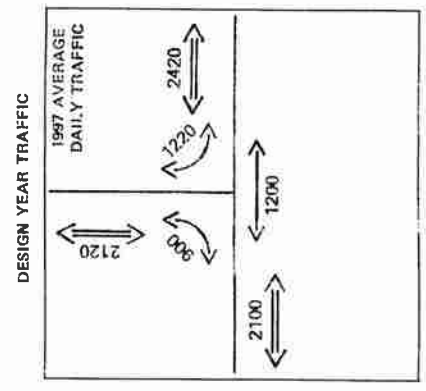

ACCIDENT EXPERIENCE AFTER CONSTRUCTION (5 years--1980-1984)

Total Accidents 0

L TAPER = 120'

20' TAPER (4' OFFSET)

20' TAPER (4' OFFSET)

Scale 1" = 50'

< (c)

(b) >

RUMBLE STRIPS 300' FROM STOP BAR (PHOTO (f))

(a) >

U.S. 65



Scale 1" = 100'



(d), (e) >



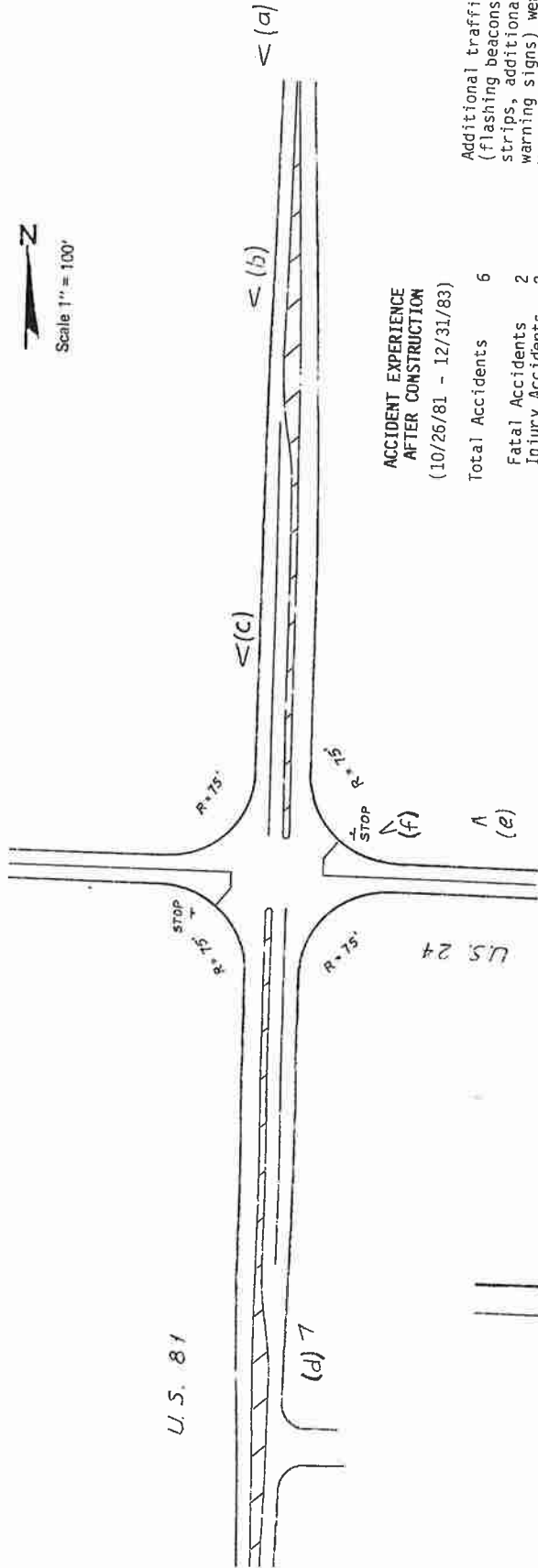

**ACCIDENT EXPERIENCE  
AFTER CONSTRUCTION  
(10/25/81 - 12/31/83)**

Total Accidents	6
Fatal Accidents	2
Injury Accidents	2
Property Damage Only Accidents	2

Accidents By Type	6
Angle	6

Additional traffic control features (flashing beacons, grooved rumble strips, additional stop signs, larger warning signs) were implemented in March 1983.

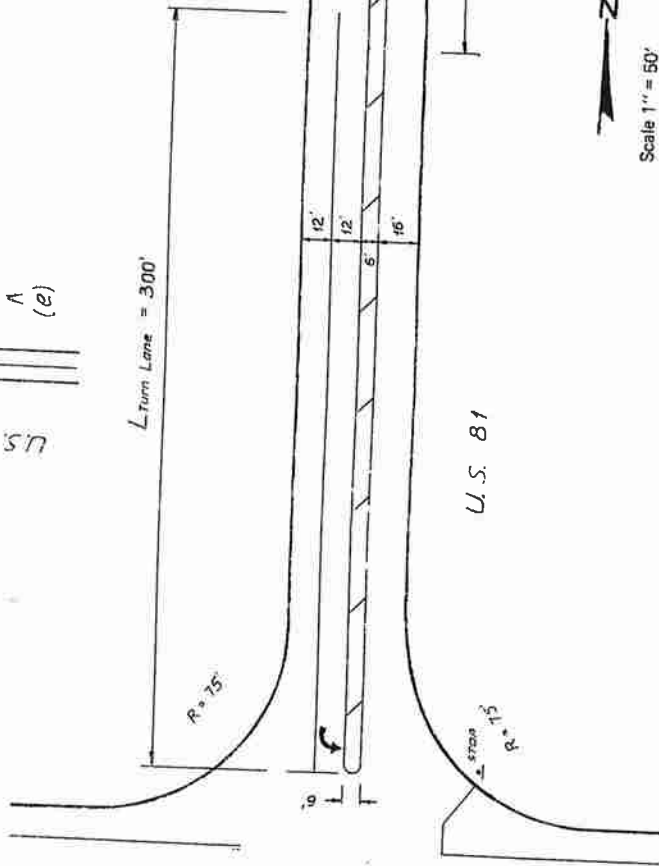

Intersection No. 2

U.S. ROUTE 24 AND U.S. ROUTE 81  
Cloud County, Kansas  
Submitted By:  
Kansas Department of Transportation



DESIGN YEAR TRAFFIC

2100	800	800	11100
12100	1400	1400	4300

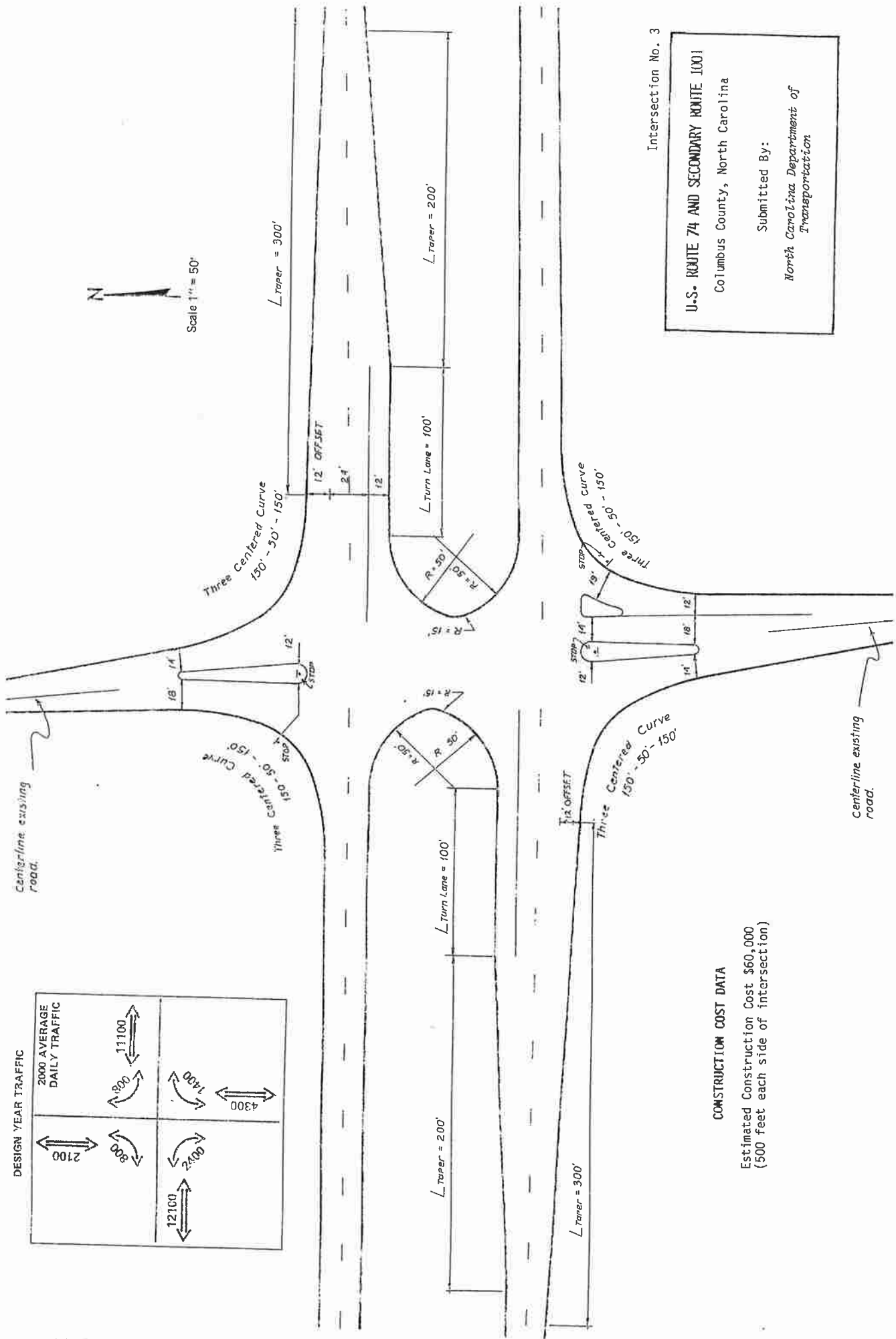

Intersection No. 3

U.S. ROUTE 74 AND SECONDARY ROUTE 1001  
 Columbus County, North Carolina  
 Submitted By:  
 North Carolina Department of Transportation

CONSTRUCTION COST DATA

Estimated Construction Cost \$60,000  
 (500 feet each side of intersection)





Scale 1" = 50'

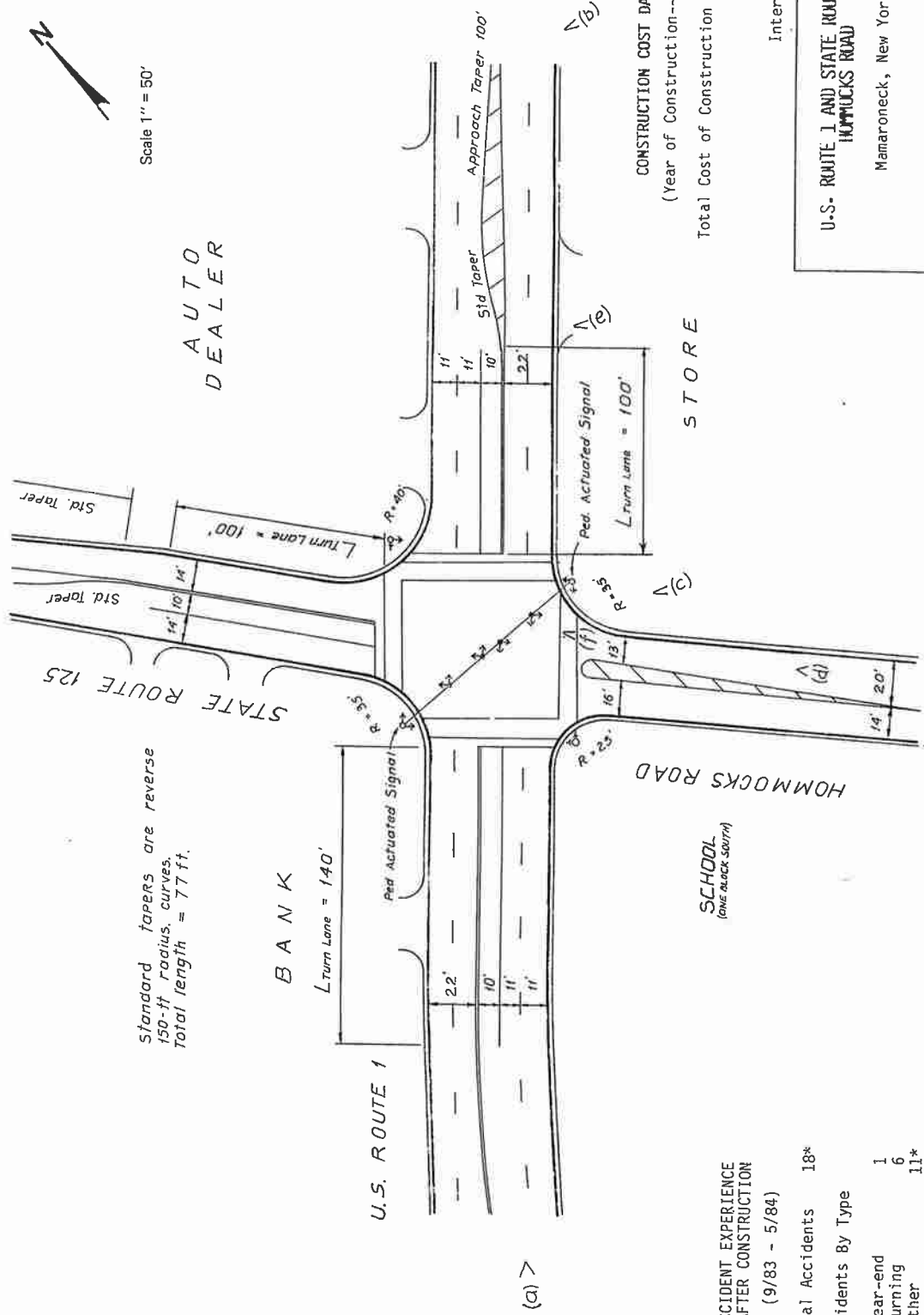

Standard tapers are reverse  
150-ft radius curves.  
Total length = 77 ft.

BANK

L<sub>turn Lane</sub> = 140'

U.S. ROUTE 1

Ped. Actuated Signal

2.2'

10'

11'

11'

HOMMOCKS ROAD

SCHOOL  
(ONE BLOCK SOUTH)

R=23'

16'

13'

14'

20'

14'

14'

14'

14'

14'

14'

14'

14'

14'

14'

14'

14'

14'

14'

14'

14'

14'

14'

(a)

(c)

(e)

(b)

Ped. Actuated Signal

L<sub>turn Lane</sub> = 100'

STORE

CONSTRUCTION COST DATA  
(Year of Construction--1983)  
Total Cost of Construction \$132,000

Intersection No. 4

U.S. ROUTE 1 AND STATE ROUTE 125/  
HOMMOCKS ROAD  
Mamaroneck, New York  
Submitted By:  
New York Department of Transportation

ACCIDENT EXPERIENCE  
AFTER CONSTRUCTION  
(9/83 - 5/84)

Total Accidents	18*
Accidents By Type	
Rear-end	1
Turning	6
Other	11*

\*9 accidents are classified as non-reportable, i.e., resulting in only very minor property damage.





U.S. ROUTES 71, 165 AND 167 AND  
RAMP FROM INTERSTATE 49

Alexandria, Louisiana

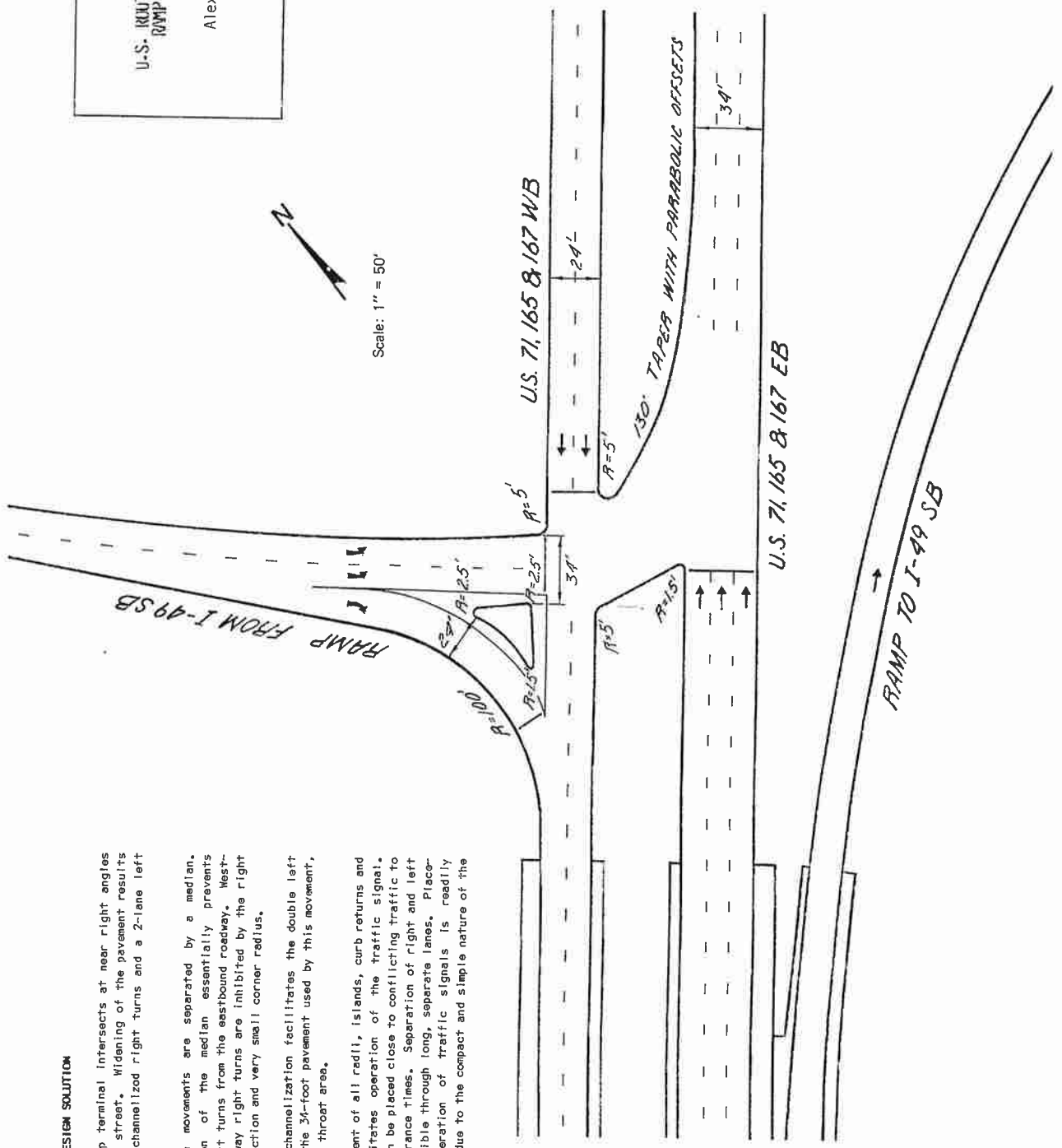

SUMMARY OF DESIGN SOLUTION

- (1) The ramp terminal intersects at near right angles to the cross street. Widening of the pavement results in separate channelized right turns and a 2-lane left turn.
- (2) Through movements are separated by a median. Channelization of the median essentially prevents wrong-way left turns from the eastbound roadway. West-bound wrong-way right turns are inhibited by the right angle intersection and very small corner radius.
- (3) Median channelization facilitates the double left turn. Note the 34-foot pavement used by this movement, and the large throat area.
- (4) Arrangement of all radii, islands, curb returns and tapers facilitates operation of the traffic signal. Stop lines can be placed close to conflicting traffic to minimize clearance times. Separation of right and left turns is possible through long, separate lanes. Placement and operation of traffic signals is readily accomplished due to the compact and simple nature of the intersection.



Intersection No. 6

STATE ROUTE 191 AND WEST WATMAUGH ROAD  
 Sonoma County, California  
 Submitted By:  
 California Department of Transportation

CONSTRUCTION COST DATA  
 (Year of Estimate--1983)

Estimated Cost of Construction	\$182,000
Roadwork	\$ 110,000
Traffic Control	10,000
Drainage	10,000
Signaling and Striping	8,500
Right of Way	15,000
Contingencies and Other	28,500
<b>Total</b>	<b>\$ 182,000</b>

SUMMARY OF DESIGN SOLUTION

- (1) Route 116 is widened to provide a full-width turning lane for storage of left turning traffic.
- (2) West Watmaugh Road is reconstructed to provide a perpendicular, tangent intersection.
- (3) A right turn lane with acceleration taper is provided for the north to west turning movement onto State Route 116.
- (4) East to north right turns onto West Watmaugh Road are accommodated by a deceleration taper.
- (5) The realignment and channelization have the effect of greatly improving sight distance from West Watmaugh Road.

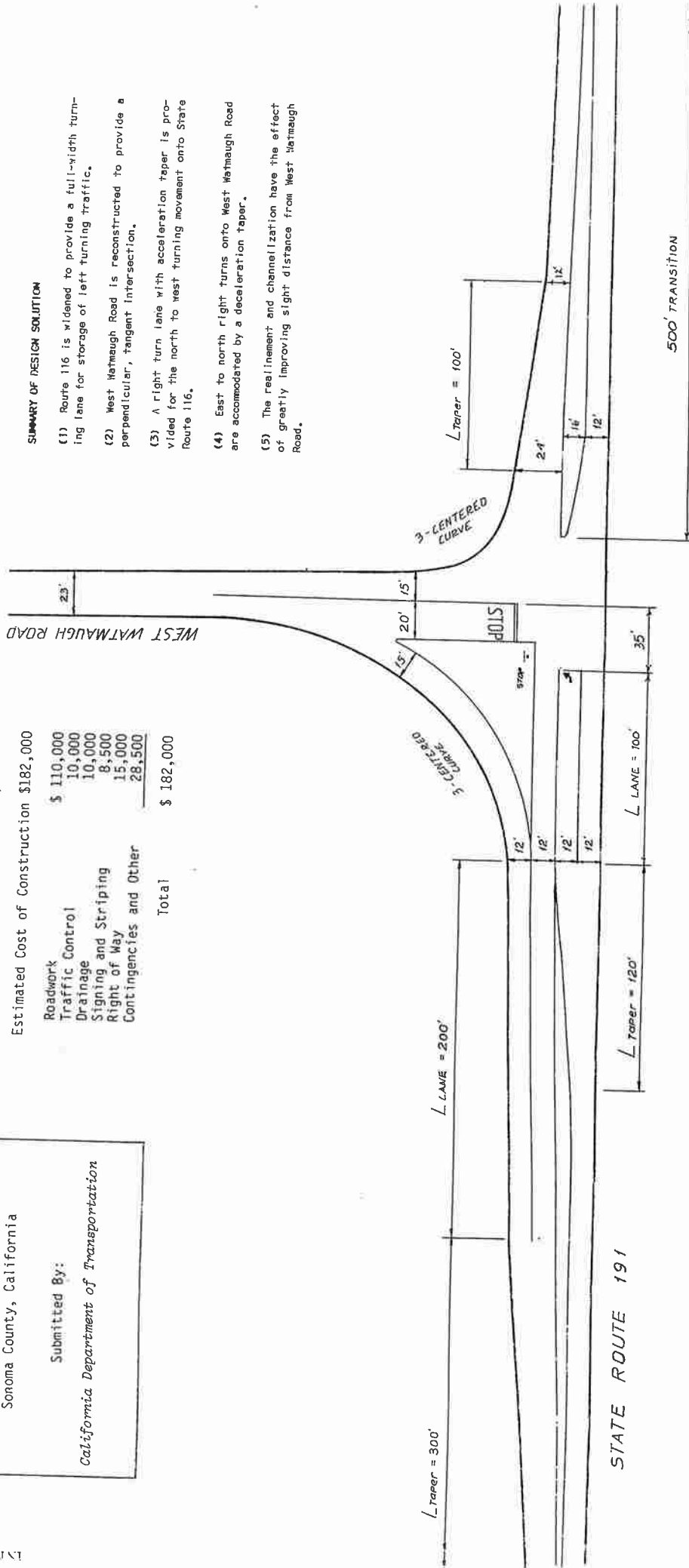

Scale 1" = 50'



STATE ROUTE 101 AND STATE ROUTE 151/  
 PORTSMOUTH AVENUE  
 Greenland, New Hampshire  
 Submitted By:  
 New Hampshire Department of Transportation

Intersection No. 7

CONSTRUCTION COST DATA  
 (Year of Construction--1979)  
 Total Cost of Construction \$401,000  
 (Includes construction, right-of-way,  
 engineering and traffic control)

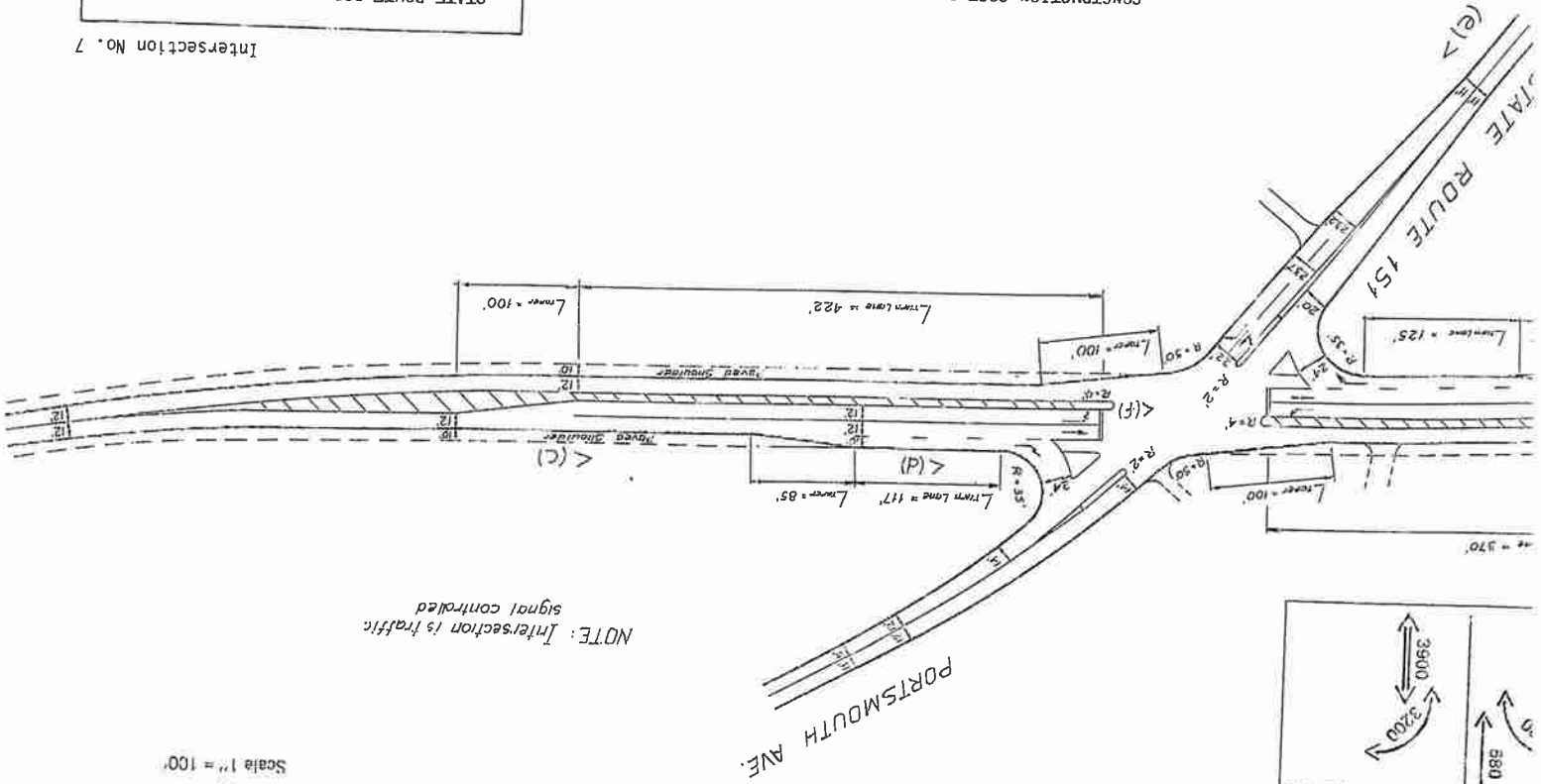

NOTE: Intersection is traffic  
 signal controlled

Scale 1" = 100'

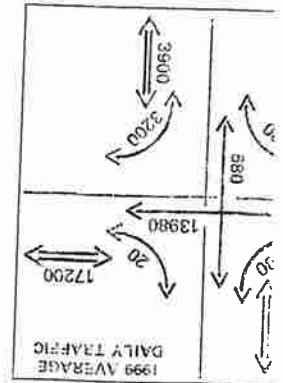

SIGN YEAR TRAFFIC



CONSTRUCTION COST DATA  
(Year of Construction--1982)  
Estimated Cost of Construction \$ 30,000

Reconstruction includes removal  
of old pavement and curb.

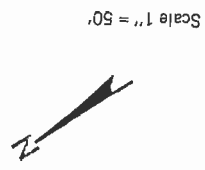
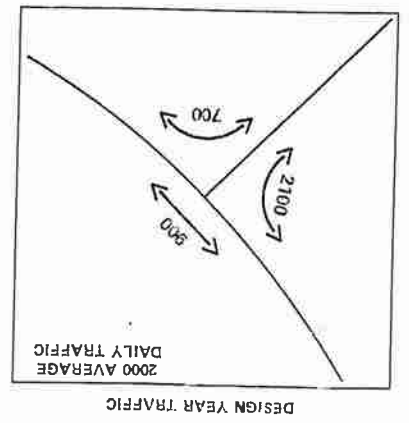
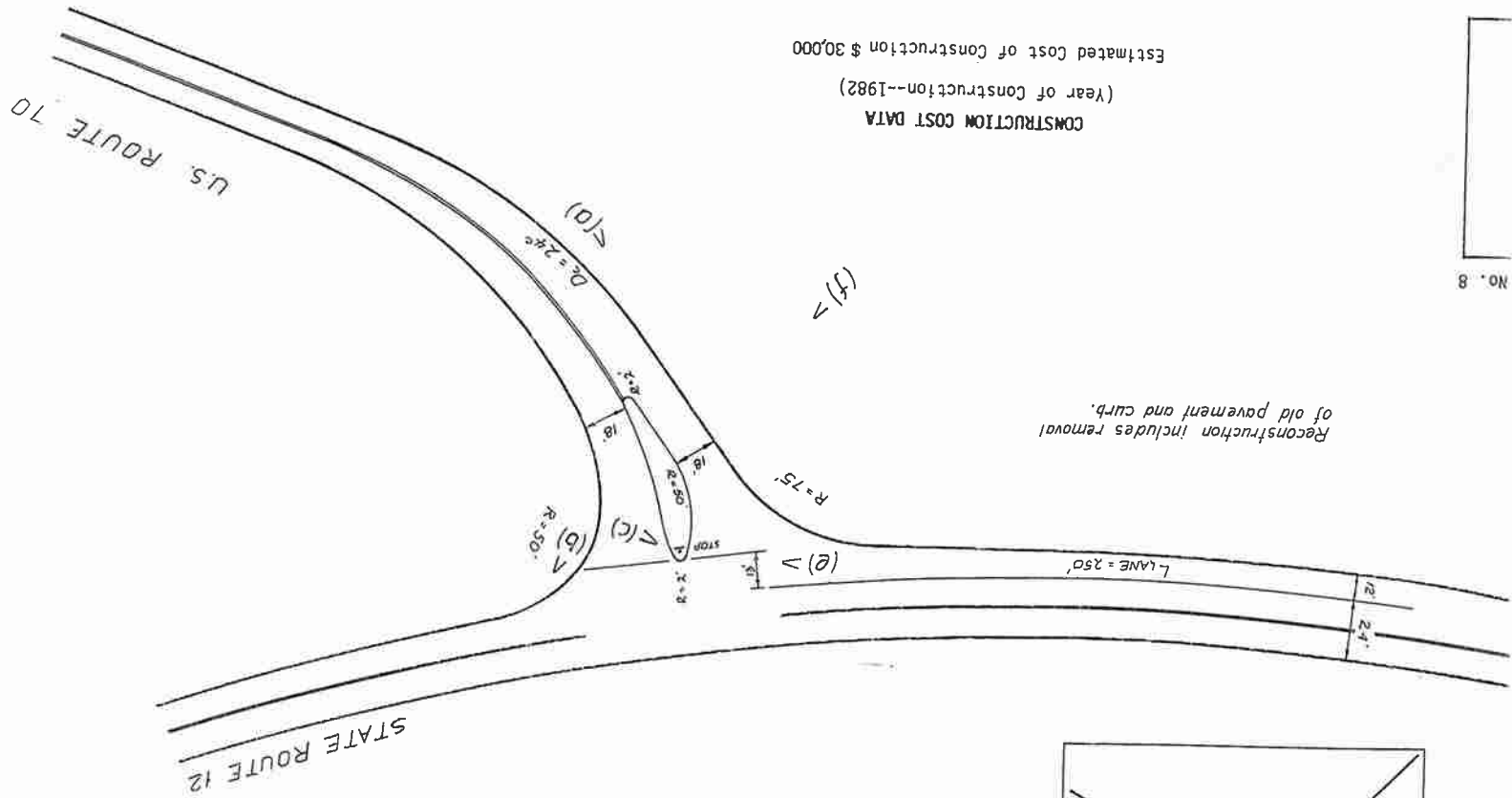

STATE ROUTE 12

U.S. ROUTE 70





Scale 1" = 100'

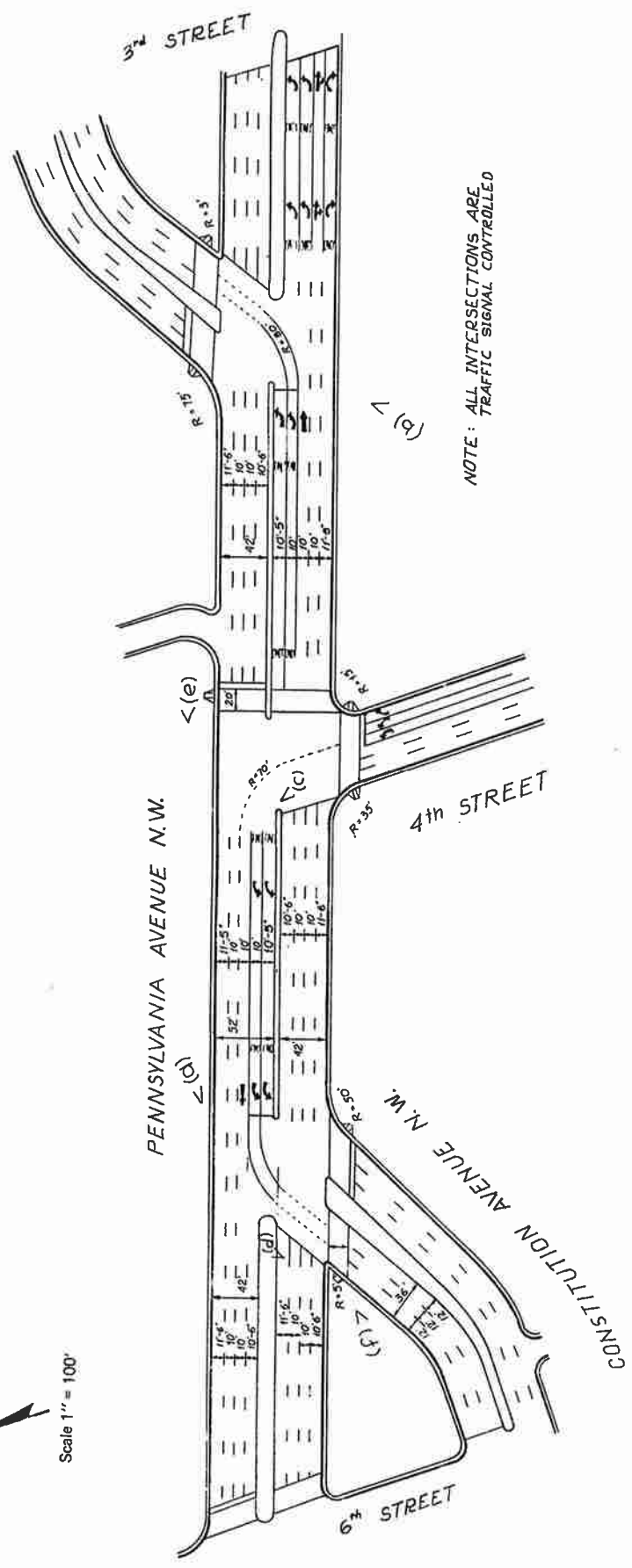

Intersection No. 9

PENNSYLVANIA AVENUE N.W. AND  
CONSTITUTION AVENUE, N.W.  
Washington, D.C.  
Submitted By:  
District of Columbia Department of  
Public Works

CONSTRUCTION COST DATA  
(Year of Estimate--1982)

Estimated Cost of Construction \$1,080,000

WR279



Intersection No. 10

**MAMMOTH ROAD, CANDIA ROAD, HAYWARD STREET AND MASSABESIC STREET**  
 Manchester, New Hampshire  
 Submitted By:  
 New Hampshire Department of Public Works  
 and Highways

**CONSTRUCTION COST DATA**  
 (Year of Construction--1979)

Total Cost of Construction	\$ 635,000
Construction	\$ 440,000
Right-of-Way	110,000
Engineering	85,000
<b>Total</b>	<b>\$ 635,000</b>

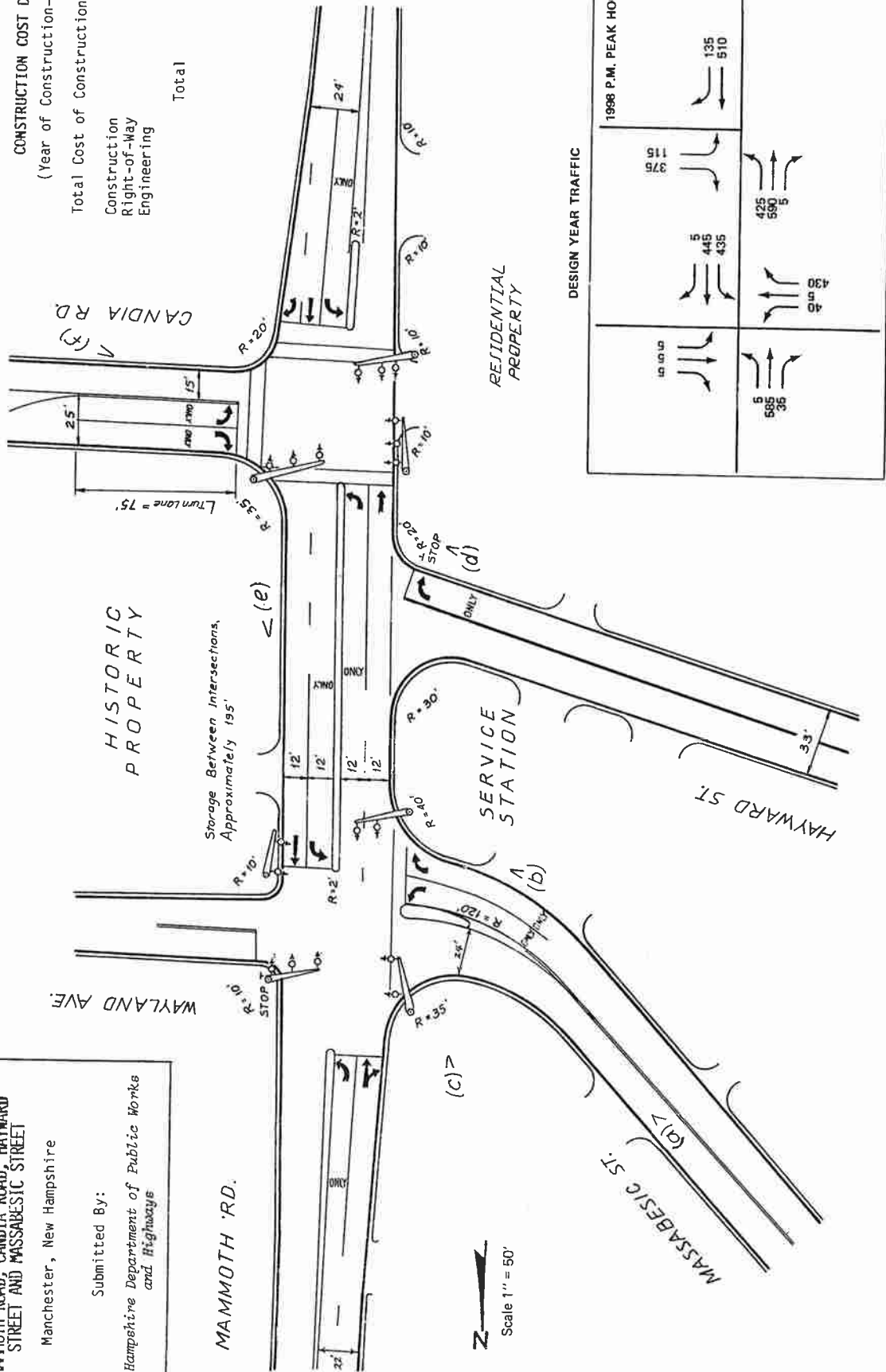

DESIGN YEAR TRAFFIC

		1988 P.M. PEAK HOUR	
		425 590 5	430 46 5
		375 115	135 510



CONSTRUCTION COST DATA  
 (Year of Estimate--1983)  
 Estimated Cost of Construction \$453,000

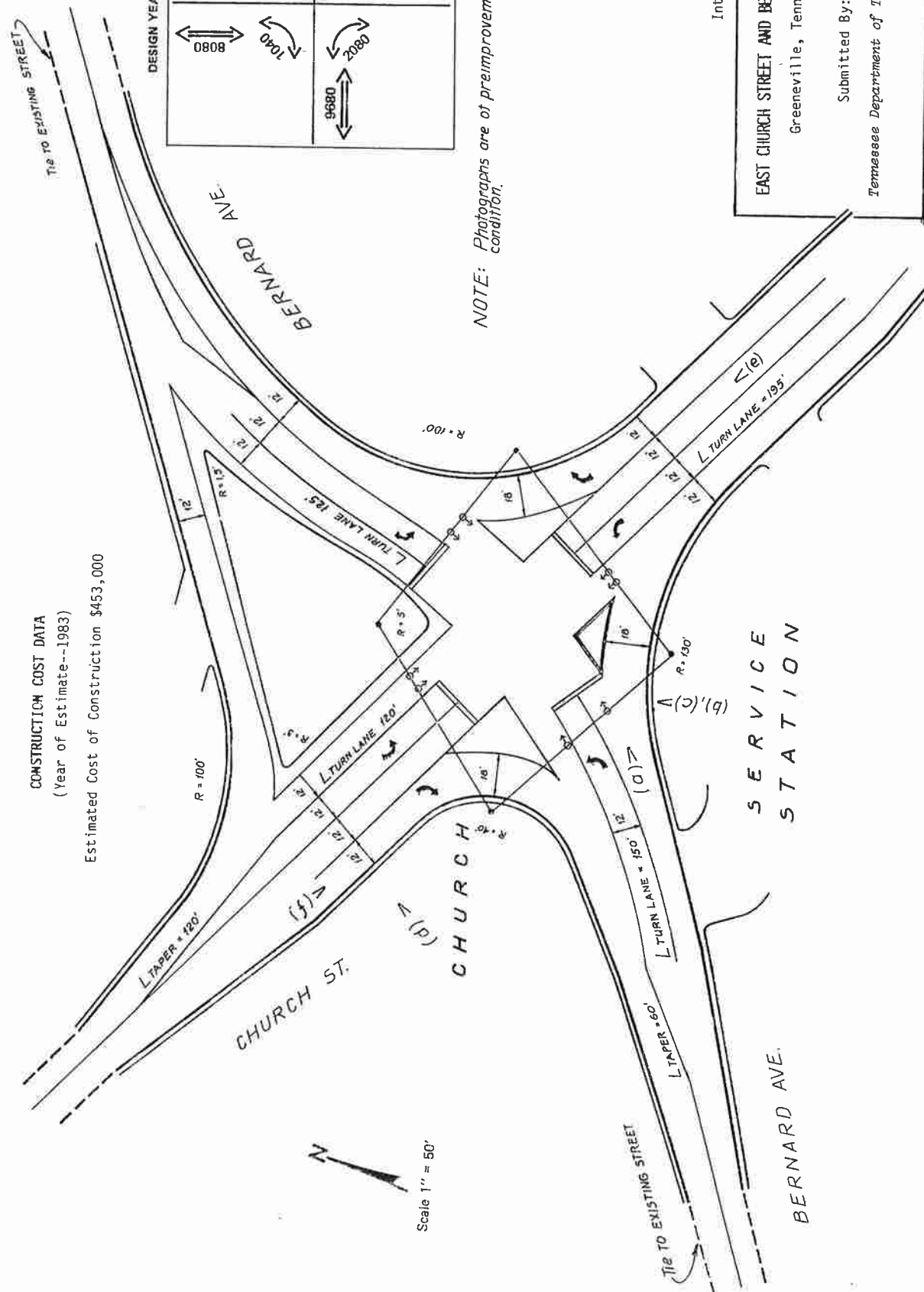

DESIGN YEAR TRAFFIC

8080	1040	16000	9280
4840	4800	4800	4800
9680	2080		

1987 AVERAGE DAILY TRAFFIC

NOTE: Photographs are of preimprovement condition.

Intersection No. 11  
**EAST CHURCH STREET AND BERNARD AVENUE**  
 Greeneville, Tennessee  
 Submitted By:  
 Tennessee Department of Transportation



Scale 1" = 50'

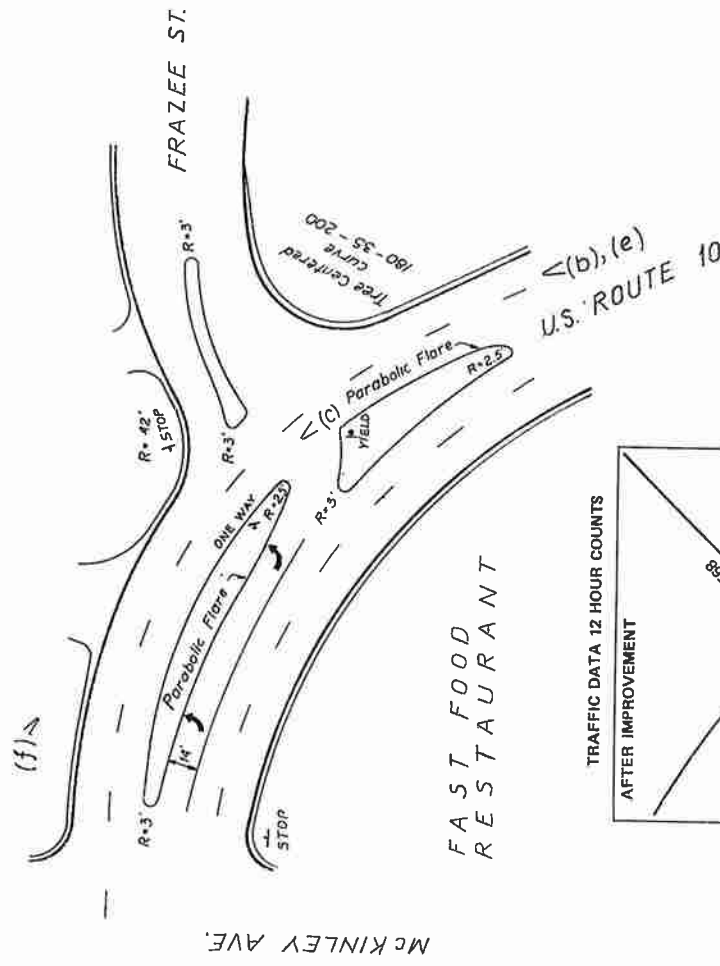

NOTE: Photographs (b) and (e) compare before and after reconstruction.

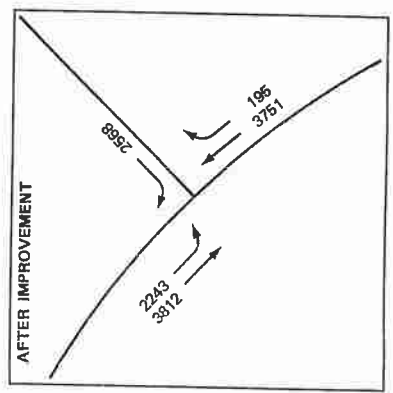

NOTE: Photographs (a) and (d) compare before and after reconstruction.

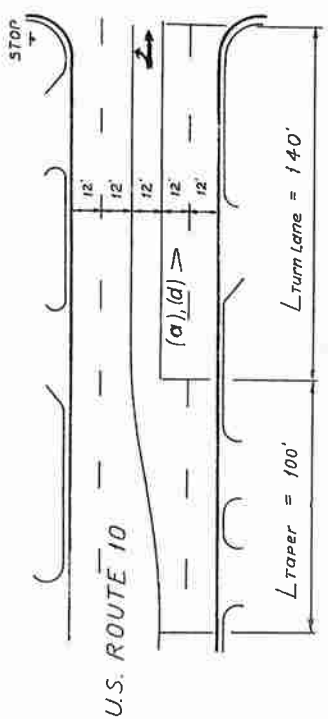

CONSTRUCTION COST DATA

(Year of Construction--1977)

Total Cost of Construction \$56,400

ACCIDENT EXPERIENCE AFTER CONSTRUCTION

(6.5 Years--1978-1984)

Total Accidents	9
Fatal Accidents	0
Injury Accidents	4
Property Damage Only Accidents	5
Accidents By Type	
Rear-end	3
Sideswipe	1
Right Angle	2
Turning	2
Other/Unknown	1

Intersection No. 12

U.S. ROUTE 10 AND FRAZEE STREET  
 Detroit Lakes, Minnesota  
 Submitted By:  
 Minnesota Department of Transportation





Intersection No. 13

**1ST AVENUE NORTH AND EXPOSITION DRIVE**

Billings, Montana

Submitted By:

Montana Department of Highways

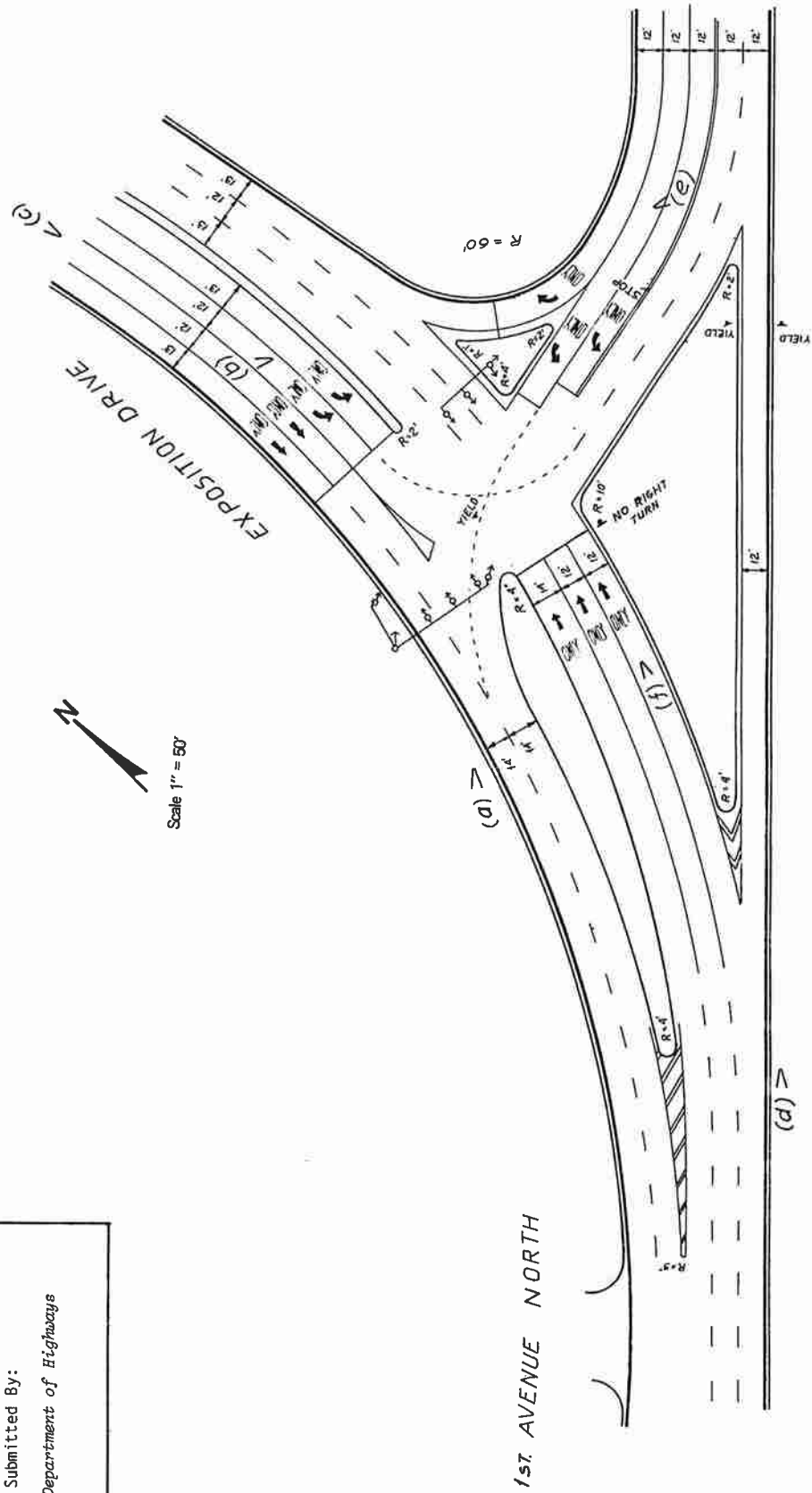



NOTE: Intersection is traffic signal controlled.

Scale 1" = 50'

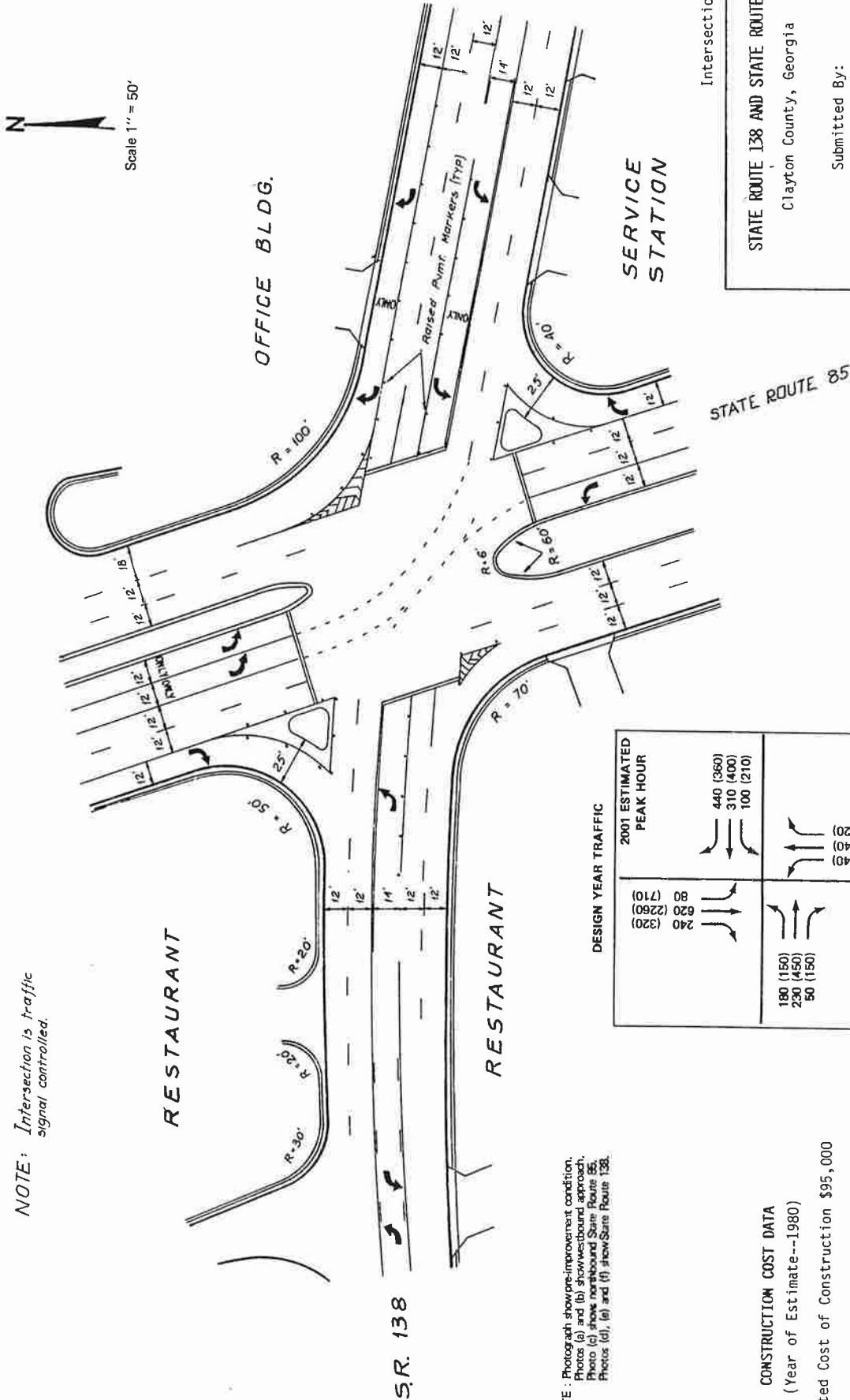

Intersection No. 14

STATE ROUTE 138 AND STATE ROUTE 85  
 Clayton County, Georgia  
 Submitted By:  
 Georgia Department of Transportation

DESIGN YEAR TRAFFIC		2001 ESTIMATED PEAK HOUR	
240 (320)	80 (710)	440 (360)	180 (220)
620 (2260)		310 (400)	2280 (840)
		100 (210)	100 (140)
180 (150)			
230 (450)			
50 (150)			
		00 - A.M. (00) - P.M.	

NOTE: Photograph shows pre-improvement condition. Photos (a) and (b) show westbound approach. Photo (c) shows northbound State Route 85. Photos (d), (e) and (f) show State Route 138.

CONSTRUCTION COST DATA  
 (Year of Estimate--1980)

Estimated Cost of Construction \$95,000



Intersection No. 15

U.S. ROUTE 3 AND U.S. ROUTE 202  
(INTERSTATE 393 CONNECTOR)  
Concord, New Hampshire  
Submitted By:  
New Hampshire Department of Public Works  
and Highways

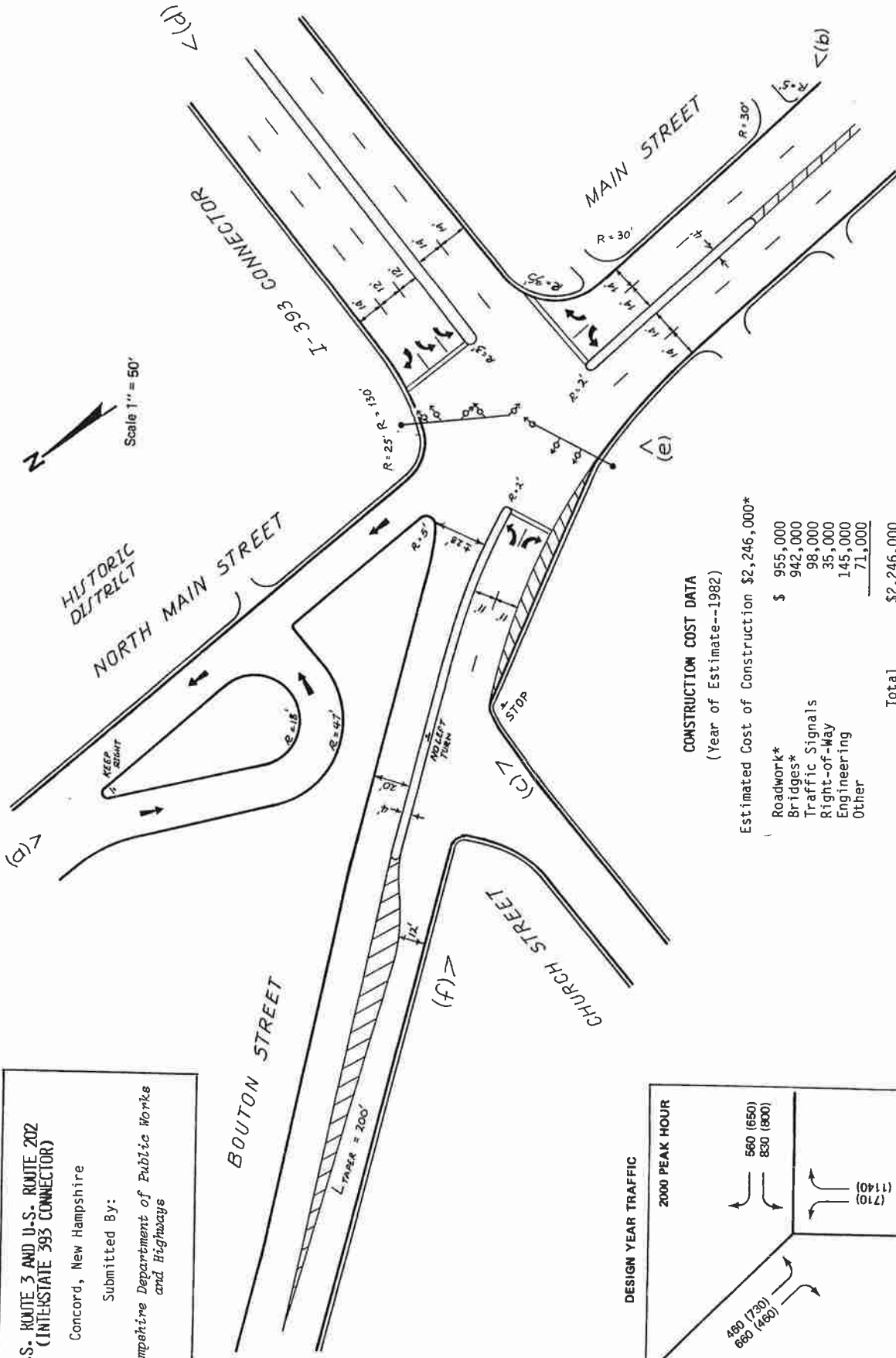

**CONSTRUCTION COST DATA**  
(Year of Estimate--1982)

Estimated Cost of Construction	\$2,246,000*
Roadwork*	\$ 955,000
Bridges*	942,000
Traffic Signals	98,000
Right-of-Way	35,000
Engineering	145,000
Other	71,000
<b>Total</b>	<b>\$2,246,000</b>

\*Project included bridge widening on I-393 connector, Costs are for approximately 0.19 miles of work.

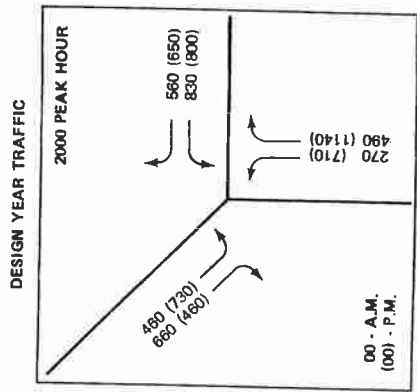



Intersection No. 16

**63RD STREET (STATE ROUTE 10)  
AND MASTIN STREET**  
Merriam, Kansas  
Submitted By:  
*Kansas Department of Highways*



Scale 1" = 50'

**ACCIDENT EXPERIENCE  
AFTER CONSTRUCTION**  
(2.5 Years--1980-1982)

Total Accidents	27
Fatal Accidents	0
Injury Accidents	11
Property Damage Only Accidents	16

**Accidents By Type**

Angle/Turning	2
Rear-end	16
Head on	1
Sideswipe	4
Other	4

**CONSTRUCTION COST DATA**

(Year of Construction--1979)

Total Cost of Construction \$253,000

(Includes grading, surfacing, signalization,  
pavement markings and landscaping)

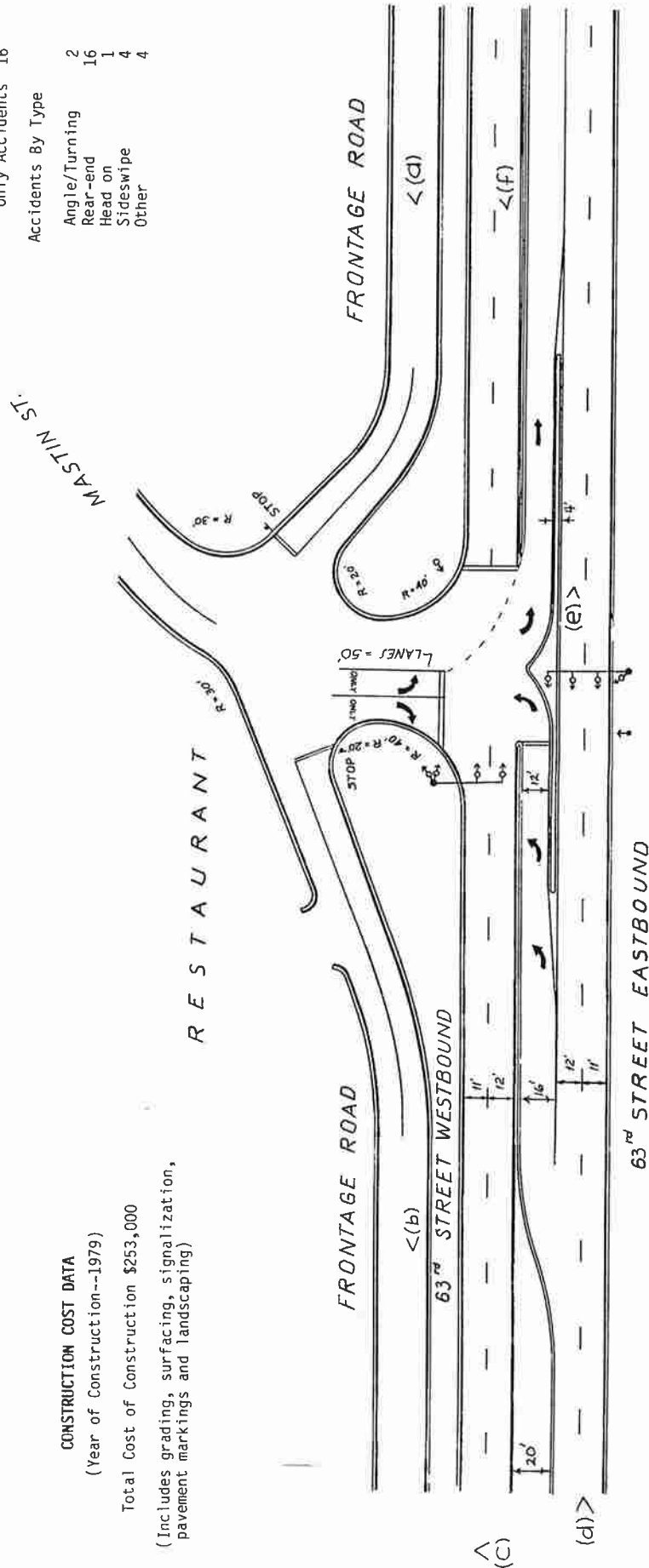





DESIGN YEAR TRAFFIC

YEAR 2000	
<p>10 (10)</p> <p>810 (280)</p> <p>110 (50)</p>	<p>10 (10)</p> <p>340 (300)</p> <p>20 (20)</p>
<p>35 (100)</p> <p>260 (350)</p> <p>680 (380)</p>	<p>(30) 10</p> <p>(1700) 280</p> <p>(750) 280</p>

00 - A.M.  
100 - P.M.

Scale 1" = 50'

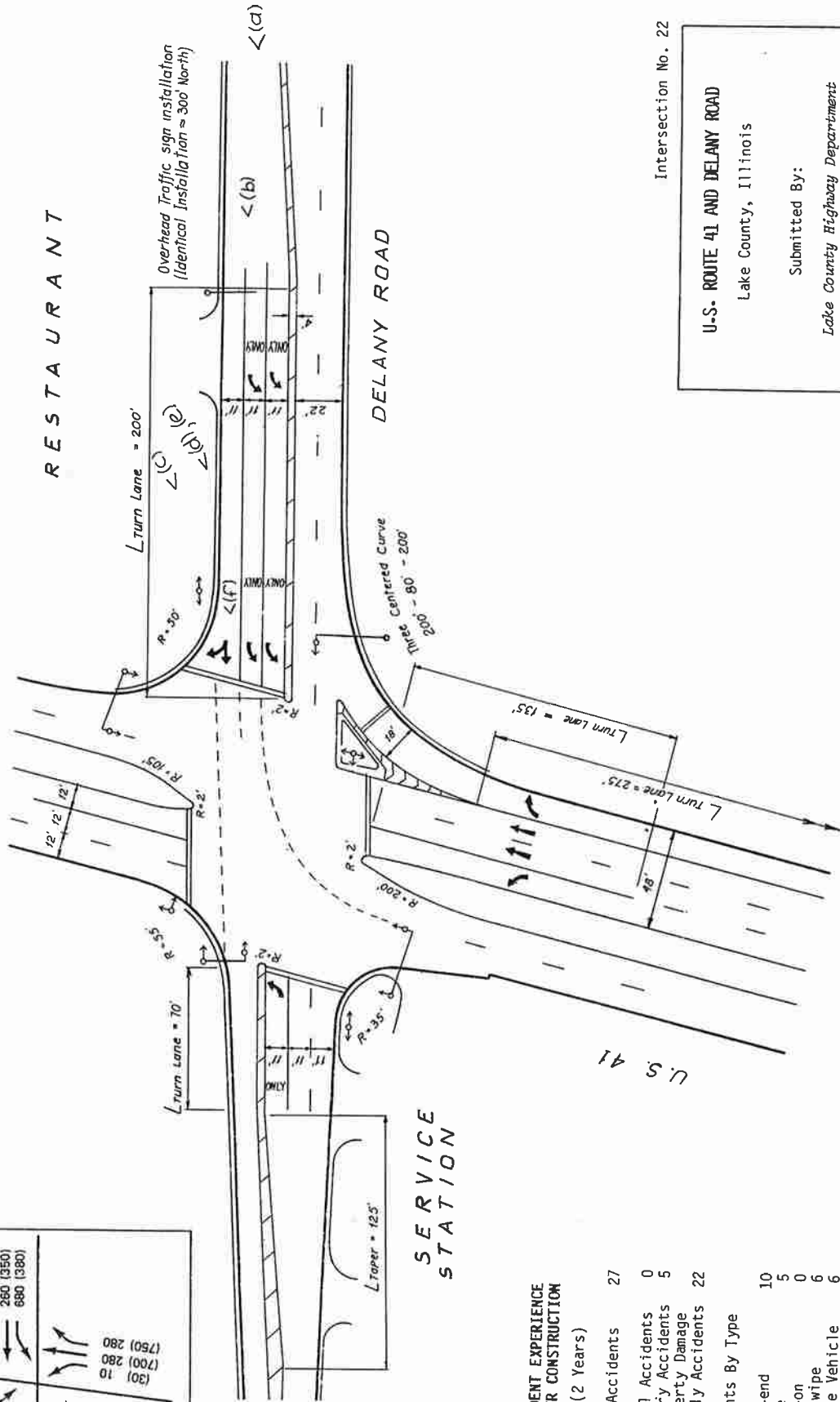

ACCIDENT EXPERIENCE AFTER CONSTRUCTION (2 Years)

Total Accidents	27
Fatal Accidents	0
Injury Accidents	5
Property Damage Only Accidents	22
Accidents By Type	
Rear-end	10
Angle	5
Head-on	0
Sideswipe	6
Single Vehicle	6

Intersection No. 22

U.S. ROUTE 41 AND DELANY ROAD

Lake County, Illinois

Submitted By:

Lake County Highway Department





Scale: 1" = 50'

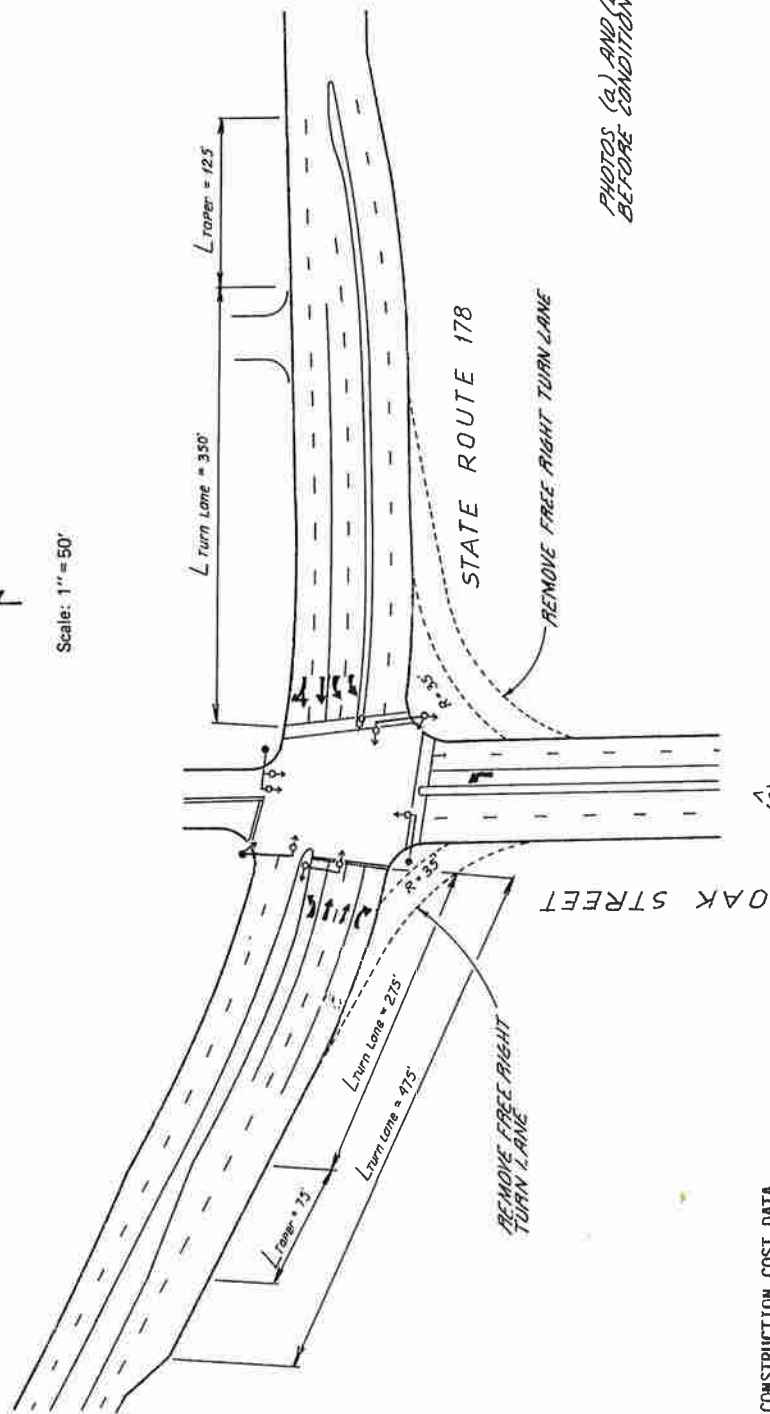

PHOTOS (a) AND (b) ARE OF BEFORE CONDITION

**CONSTRUCTION COST DATA**  
(Year of Estimate--1981)

Estimated Cost of Construction	\$ 215,000
Construction Right-of-Way	\$ 195,000
	<u>20,000</u>
<b>Total</b>	<b>\$ 215,000</b>

Intersection No. 23

**STATE ROUTE 178 AND OAK STREET**

Bakersfield, California

Submitted By:

California Department of Transportation



Scale 1" = 100'

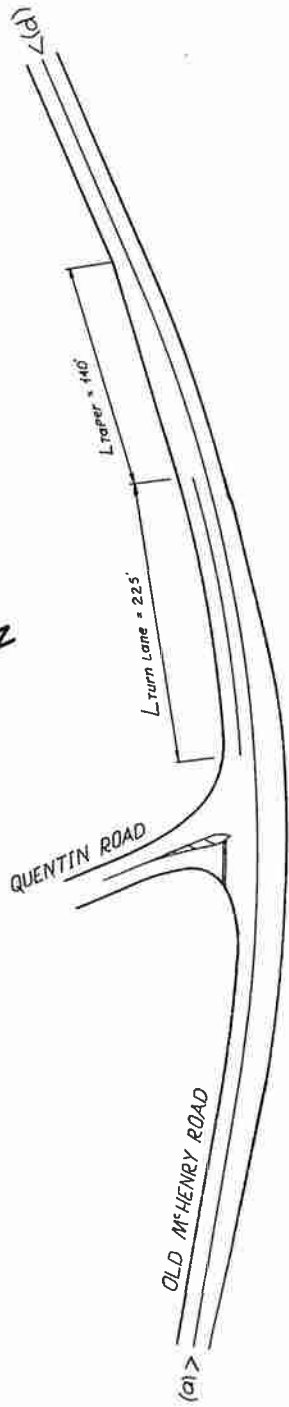

Scale 1" = 50'

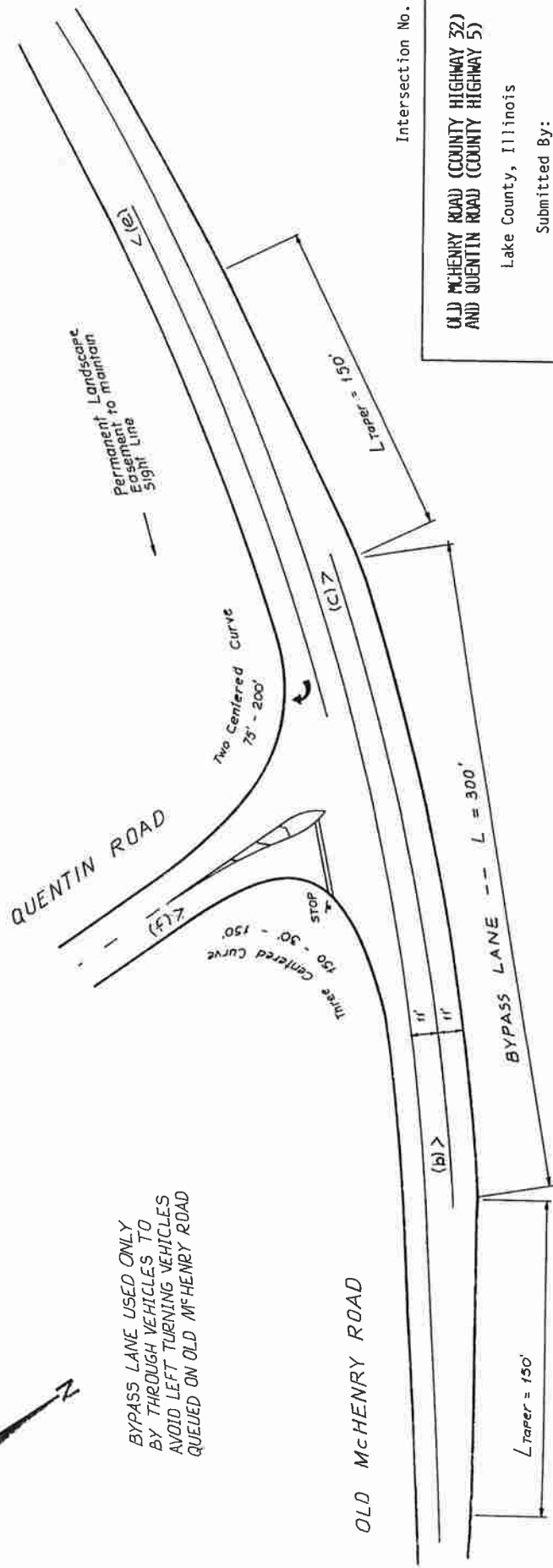

BYPASS LANE USED ONLY  
 BY THROUGH VEHICLES TO  
 AVOID LEFT TURNING VEHICLES  
 QUEUED ON OLD McHENRY ROAD

Intersection No. 24

OLD McHENRY ROAD (COUNTY HIGHWAY 32)  
 AND QUENTIN ROAD (COUNTY HIGHWAY 5)

Lake County, Illinois

Submitted By:

Lake County Highway Department



**RESIDENTIAL**

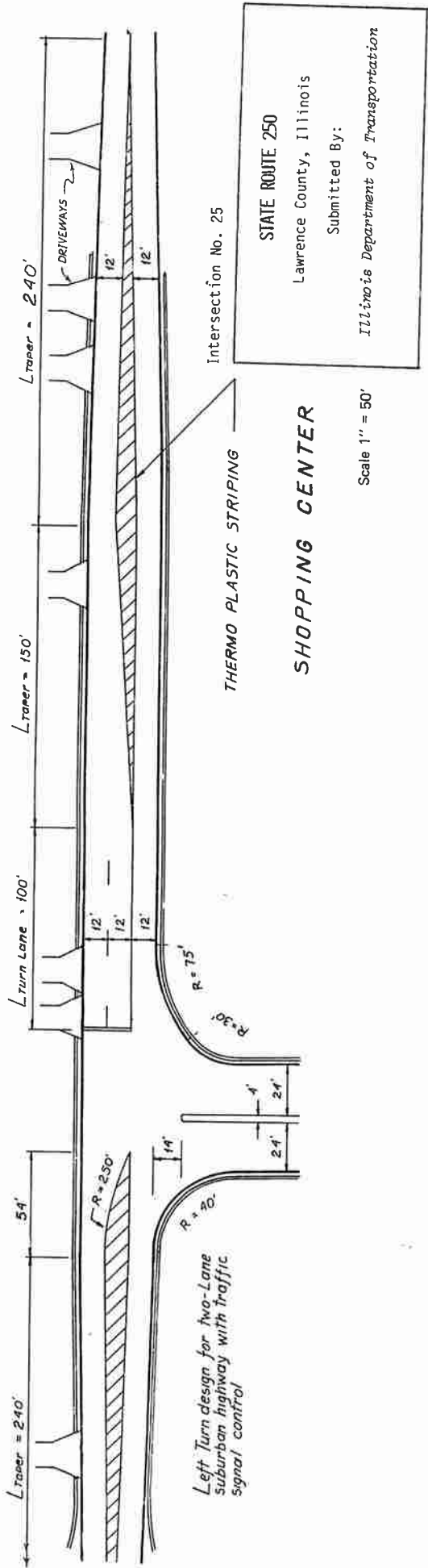

Intersection No. 26

**STATE ROUTE 200**  
Sanders County, Montana  
Submitted By:  
Montana Department of Transportation

Scale 1" = 50'

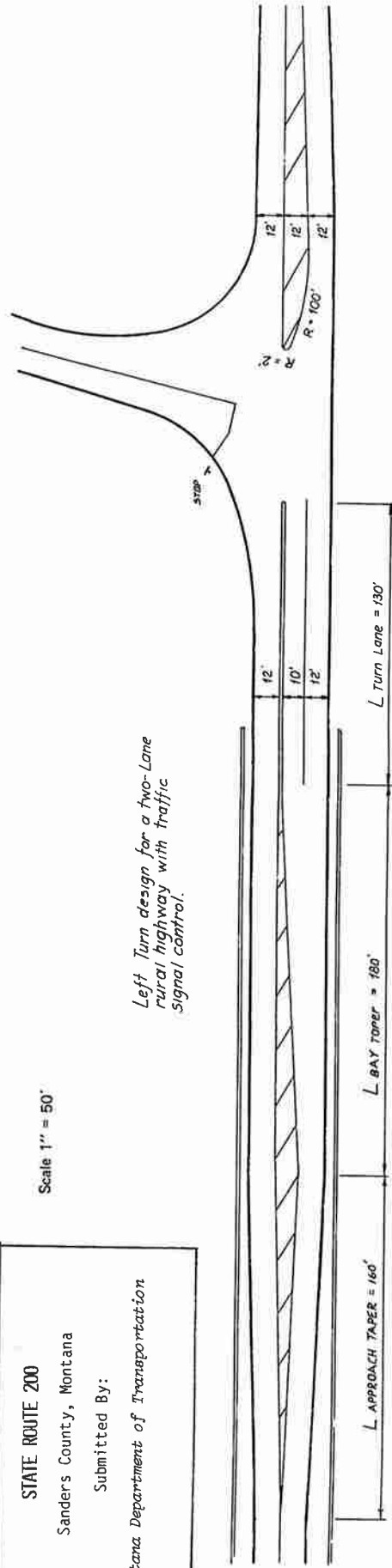





WOVERINE BLVD.

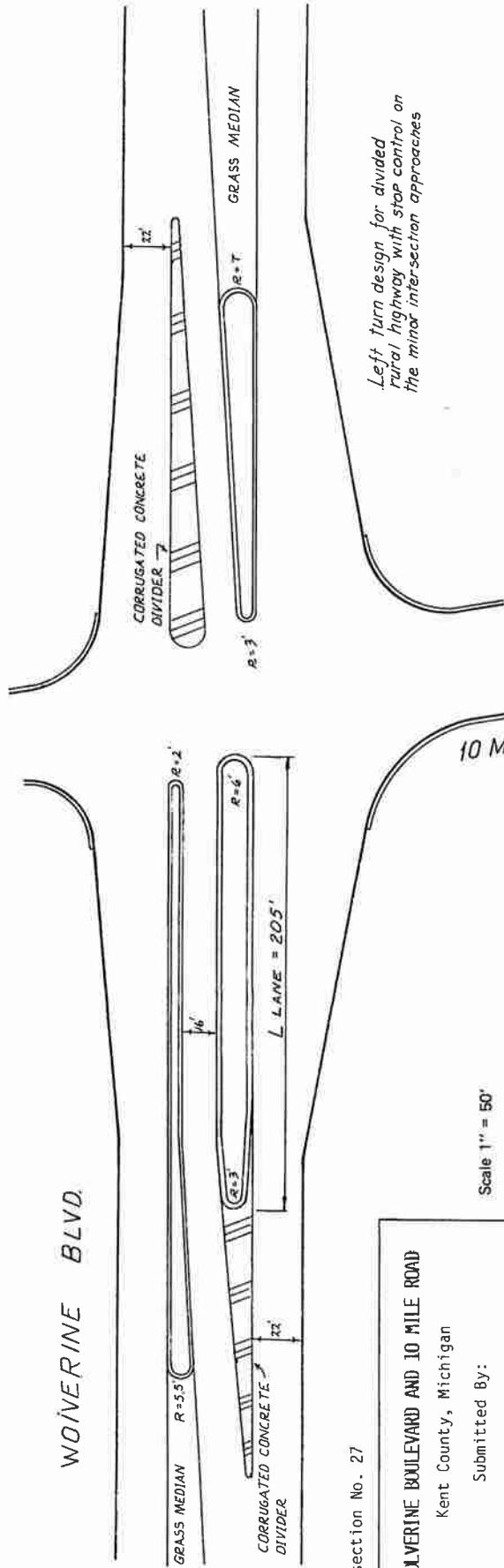

Intersection No. 27

**WOLVERINE BOULEVARD AND 10 MILE ROAD**

Kent County, Michigan

Submitted By:

Kent County Highway Department

Scale 1" = 50'

*Left turn design for divided rural highway with stop control on the minor intersection approaches*

*Left turn design for high speed divided rural highway with stop control on the minor intersection approaches.*

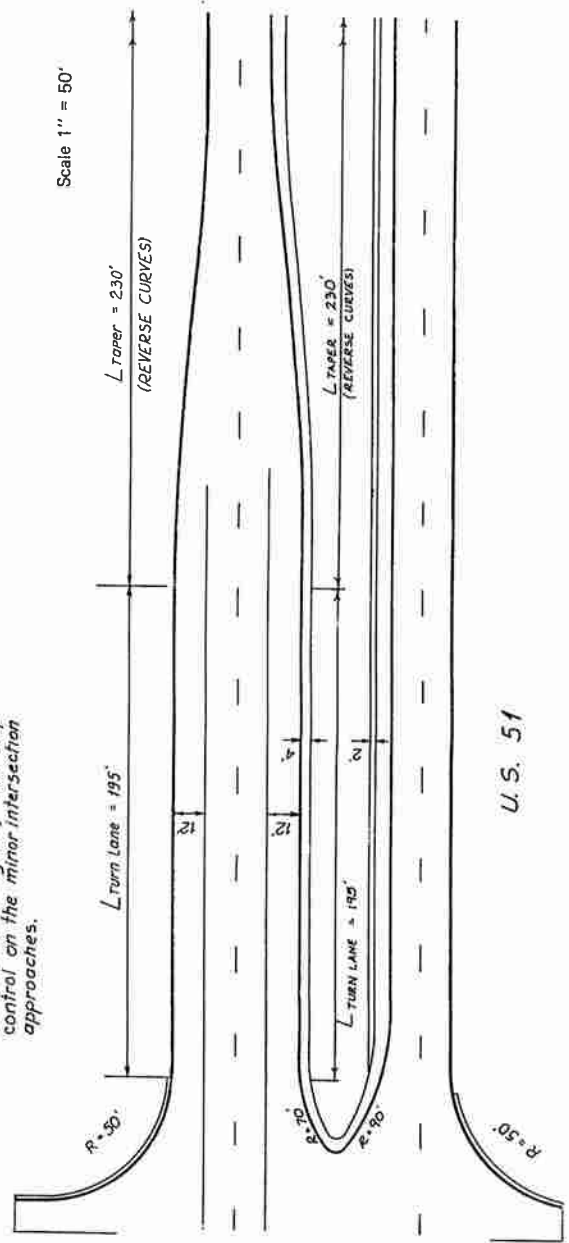

Intersection No. 28

**U.S. ROUTE 51**

De Witt County, Illinois

Submitted By:

Illinois Department of Transportation

Scale 1" = 50'

U.S. 51



DESIGN YEAR TRAFFIC

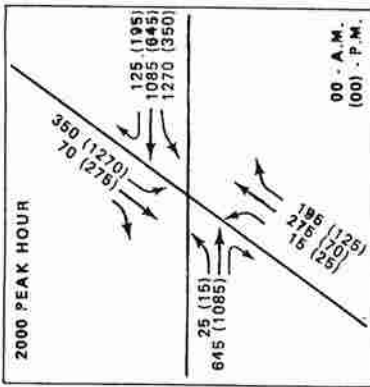

Scale 1" = 50'

CONSTRUCTION COST DATA  
(Year of Estimate--1980)

Estimated Cost of Construction	\$ 228,000
Roadwork	\$ 155,000
Traffic Signals	12,000
Engineering	26,000
Contingencies	35,000
<b>Total</b>	<b>\$ 228,000</b>

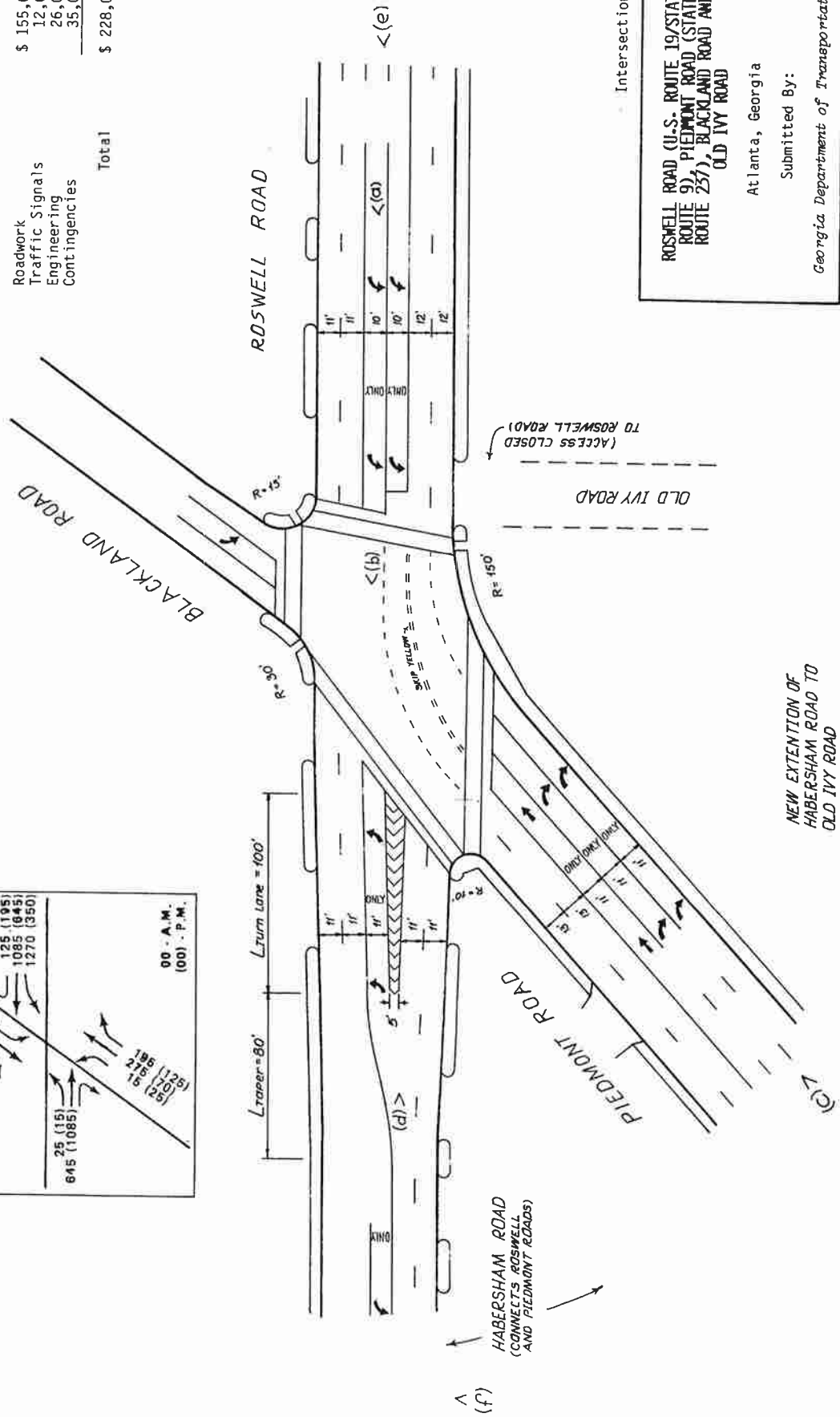

Intersection No. 34

ROSWELL ROAD (U.S. ROUTE 19/STATE ROUTE 9), PIEDMONT ROAD (STATE ROUTE 237), BLACKLAND ROAD AND OLD IVY ROAD

Atlanta, Georgia  
Submitted By:  
Georgia Department of Transportation

NEW EXTENSION OF HABERSHAM ROAD TO OLD IVY ROAD







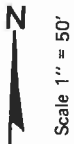

Scale 1" = 50'

CONSTRUCTION COST DATA  
(Year of Estimate--1983)

Estimated Cost of Construction \$250,000

MISSION STREET (STATE ROUTE 82)  
AND WESTLAKE AVENUE

Daly City, California

Submitted By:  
California Department of Transportation

Photos (a) and (b) taken on northbound approach south of Grambeta St.

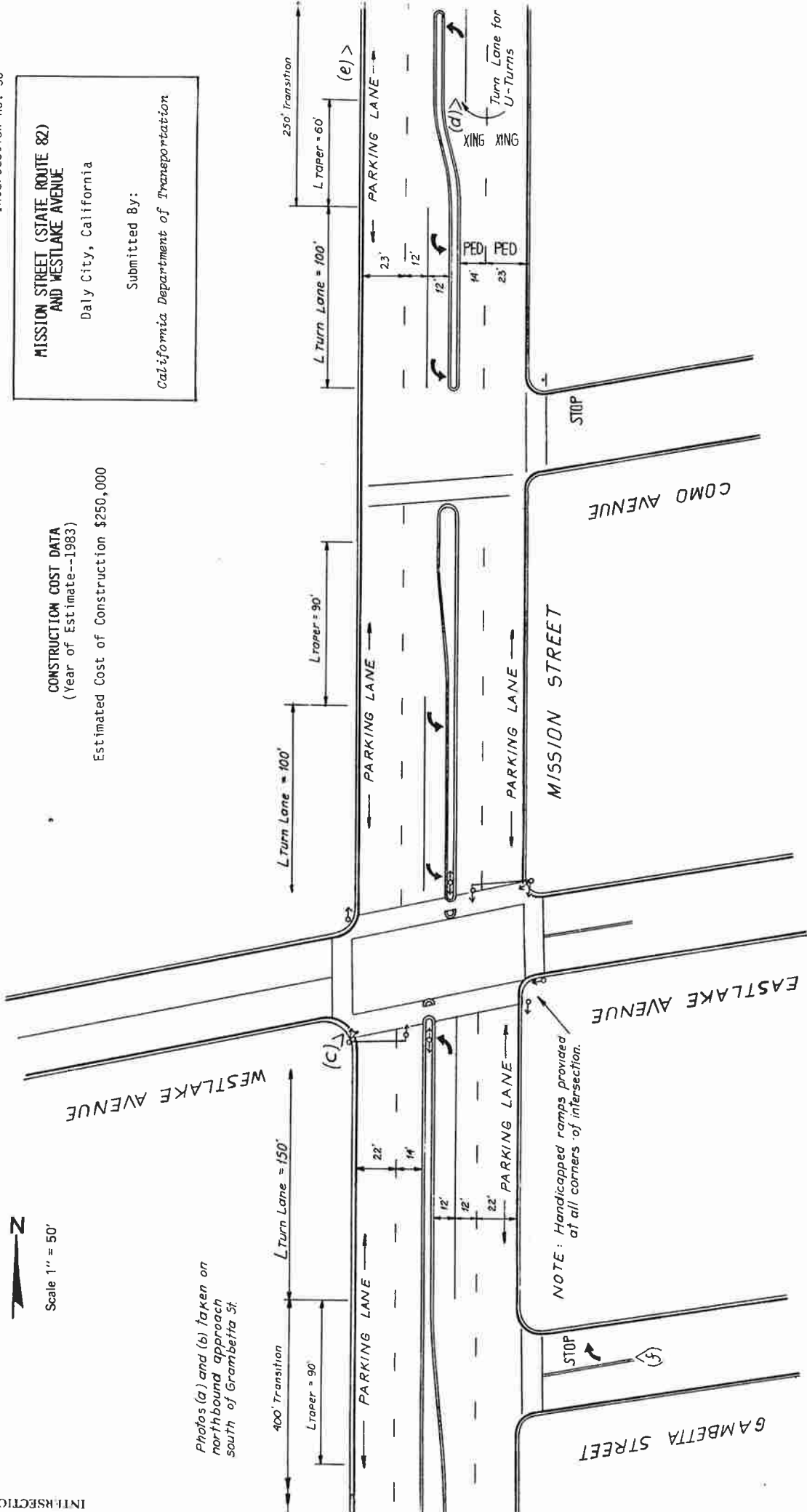

NOTE: Handicapped ramps provided at all corners of intersection.

STOP

COMO AVENUE

MISSION STREET

EASTLAKE AVENUE

GRAMBETTA STREET

L Turn Lane = 100'

L taper = 90'

L Turn Lane = 100'

L Taper = 60'

230' Transition

(e) >

23'

12'

12'

14'

23'

PARKING LANE

PARKING LANE

PARKING LANE

PARKING LANE

(c) >

L Turn Lane = 150'

400' Transition

L Taper = 90'

22'

14'

12'

12'

22'

PARKING LANE

PARKING LANE

(d) >

PED

PED

BIX

BIX

TURN LANE for U-TURNS

TURN LANE for U-TURNS





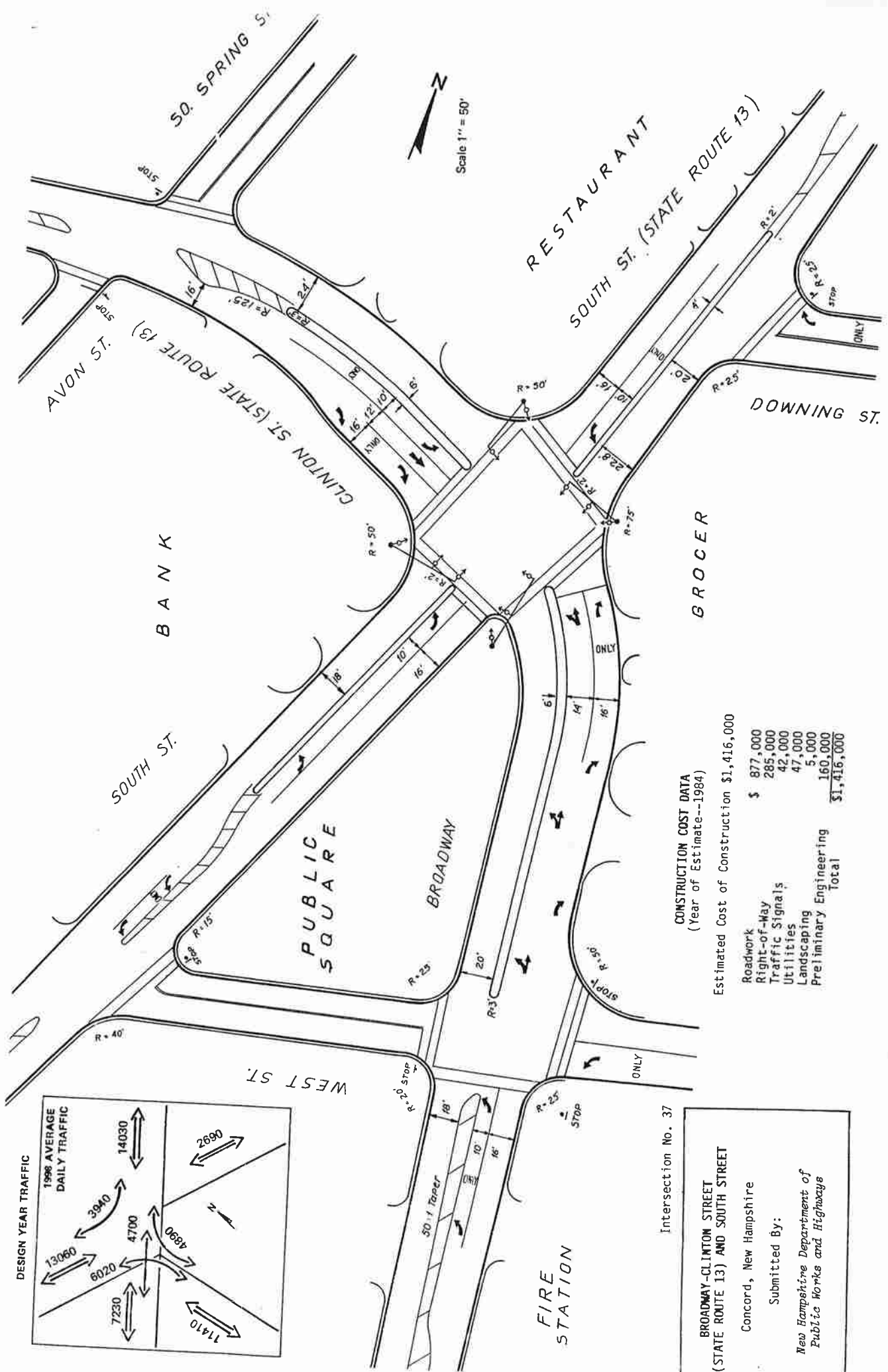
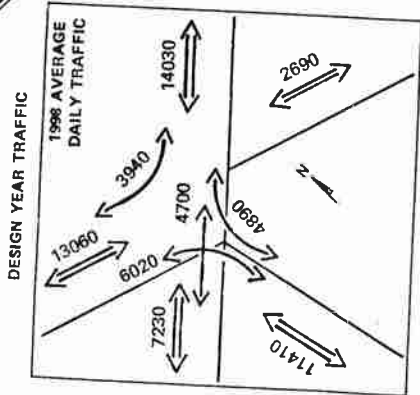

CONSTRUCTION COST DATA  
(Year of Estimate--1984)

Estimated Cost of Construction \$1,416,000

Roadwork	\$ 877,000
Right-of-Way	285,000
Traffic Signals	42,000
Utilities	47,000
Landscaping	5,000
Preliminary Engineering	160,000
<b>Total</b>	<b>\$1,416,000</b>

Intersection No. 37

BROADWAY-CLINTON STREET  
(STATE ROUTE 13) AND SOUTH STREET

Concord, New Hampshire

Submitted By:

New Hampshire Department of  
Public Works and Highways

