

**Gravina Access Project
Supplemental Environmental Impact Statement
HP-NCPD-922(5) / 67698**

Construction Cost Estimate Report



Prepared for:



**Department of Transportation and Public Facilities
Southeast Region**

Prepared by:



**HDR Alaska
2525 "C" Street, Suite 305
Anchorage, Alaska 99503-2632**



August 2012

EXECUTIVE SUMMARY

The purpose of this *Construction Cost Estimate Report* for the Gravina Island Access is to present cost estimates for the reasonable alternatives to be considered in the Gravina Access Project *Supplemental Environmental Impact Statement* (SEIS).

The cost for the preferred alternative identified in the 2004 *Record of Decision* (ROD) based on the Gravina Access Project *Environmental Impact Statement* (EIS), exceeded the funding that was available for the project, or was expected to become available in the foreseeable future. In 2008, the Department of Transportation and Public Facilities, Southeast Region (Department), determined that the 2004 cost estimates associated with the alternatives evaluated in the EIS should be updated to then current (2008) dollars. These estimates were to be used in the identification of reasonable alternatives to be evaluated in the SEIS.

HDR Alaska reassessed the costs of the six bridge alternatives (C3a, C3b, C4, D1, F1, and F3) and three ferry alternatives (G2, G3, and G4) evaluated in the EIS, as well as the No Action Alternative. Costs for a movable bridge alternative (M1) and a tunnel alternative (T1) were also developed. In addition, HDR evaluated a combined C3 and C4 bridge alternative, and a design variation of Alternative F3 to investigate potential cost savings resulting from changing the design speed, adding an extended approach embankment to or beyond the water's edge (causeway fill to shorten structure length), additional encroachment into the Part 77 airspace, adjusting existing vessel tracklines, or using different component or structure types. These design variants were presented as Alternatives C3-4 and F3v. The new estimates were also to include the parts of the Gravina Island Highway yet to be constructed. Subsequently, a phased construction approach to the airport ferry alternative (G4), and an alignment modification to the movable bridge alternative (M1) were requested to be considered, and identified as Alternatives G4v and M2, respectively. All these alternatives were described in the *Construction Cost Estimate Report of the Alternatives to be Considered in the SDEIS Screening Process*, dated July 31, 2009 ([SEIS Cost Report 73109 FINAL.pdf](#)).

All alternatives were presented to local government and resource agencies for comment, and evaluated against screening criteria, as summarized in the *Alternatives Screening Report*, dated March 2010 ([gravina access SEIS screening report march 2010.pdf](#)). The screening process resulted in the identification of six reasonable build alternatives to be evaluated in the SEIS, namely C3-4, F3, G2, G3, G4, and G4v, in addition to the No Action Alternative.

This *Construction Cost Estimate Report* presents the construction costs for the two bridge alternatives, C3-4 and F3-1 (so named only in this document to reflect a minor change to Alternative F3 where it connects with the existing Gravina Island Highway: for all other purposes, Alternatives F3-1 and F3 are the same); the four ferry alternatives, G2, G3, G4, and G4v; and the aforementioned No Action Alternative, updated now to 2011 construction dollars.

To ensure a true comparison of the long-term costs of the alternatives, a life-cycle cost analysis was conducted for each reasonable alternative. Life-cycle costs incorporate the owner's operation and maintenance costs, as well as revenues expected from bridge tolls or ferry revenue.

Additionally, the total-life costs for the bridges and ferries were calculated to determine what the total estimated funding requirements over time would be at the end of the 75-year design life.

Table 1 summarizes the estimated construction cost; 75-year life-cycle cost, both without and with toll revenue; and the total life-time cost, both without and with revenue, for each alternative considered in this report.

Table 1: Construction, Life-Cycle, and Total Life-time Costs (without and with revenue)

| Alternative | Construction Cost | Life-Cycle Cost | Life-Cycle Cost (revenue adjusted) | Total Life-Time Cost | Total Life-Time Cost (revenue adjusted) |
|-------------|-------------------|-----------------|------------------------------------|----------------------|---|
| C3-4 | \$ 223 M | \$ 222 M | \$ 214 M | \$ 391 M | \$ 335 M |
| F3-1 | 276 M | 286 M | 280 M | 576 M | 531 M |
| G2 | 81 M | 331 M | 265 M | 1,330 M | 879 M |
| G3 | 70 M | 314 M | 247 M | 1,262 M | 811 M |
| G4 | 62 M | 301 M | 234 M | 1,207 M | 756 M |
| G4v | 23 M | 182 M | 132 M | 1,050 M | 712 M |
| No Action | 0 M | 88 M | 35 M | 929 M | 590 M |

Note: Costs are in 2011 dollars

Table of Contents

| | |
|---|----|
| Executive Summary | i |
| 1.0 Introduction | 1 |
| 1.1 Purpose of this Report | 1 |
| 1.2 Project Background..... | 1 |
| 2.0 Design Considerations Summary | 3 |
| 2.1 Traffic Volumes..... | 3 |
| 2.2 Typical Section | 5 |
| 2.3 Design Speed | 6 |
| 2.4 Profile Grade..... | 6 |
| 2.5 Navigational Clearances | 6 |
| 2.6 FAA Part 77 | 7 |
| 2.7 USCG Lighting..... | 7 |
| 2.8 Ferries | 7 |
| 2.9 Pedestrians..... | 8 |
| 2.10 Utilities | 8 |
| 3.0 Reasonable Alternatives Described..... | 10 |
| 3.1 Alternative C3-4 | 10 |
| 3.2 Alternative F3-1 | 12 |
| 3.3 Alternative G2..... | 13 |
| 3.4 Alternative G3..... | 13 |
| 3.5 Alternative G4..... | 14 |
| 3.6 Alternative G4v | 14 |
| 3.7 No Action Alternative | 15 |
| 3.8 Features Common to All the Alternatives | 15 |
| 4.0 Maintenance and Operations Costs | 16 |
| 4.1 Bridges | 16 |
| 4.2 Roadways..... | 16 |
| 4.3 Ferries and Docks..... | 16 |
| 4.4 Annual M&O Costs | 17 |
| 5.0 Construction Cost Estimate..... | 19 |
| 5.1 Bridge Structure | 19 |
| 5.2 Roads | 19 |
| 5.3 Ferry Facilities | 19 |
| 5.4 Right-of-Way..... | 20 |
| 5.5 Design and Construction Costs..... | 21 |
| 5.6 Total Construction Costs..... | 21 |
| 6.0 Life-Cycle Costs | 22 |
| 7.0 Tolls | 23 |
| 8.0 Total Life-Time Costs | 25 |
| 9.0 Conclusion | 27 |

Figures

| | |
|--|----|
| Figure 1: Gravina Island Access Vicinity Map | 1 |
| Figure 2: Visitor Traffic Trends | 3 |
| Figure 3: New Approach Roadway Typical Section | 5 |
| Figure 4: Waiting Area, Freight Dock and Lay-up Berth | 9 |
| Figure 5: Alternative C3-4 bridge from north of Wolff Point on North Tongass Highway, looking south..... | 10 |
| Figure 6: Alternative F3-1 bridges and Pennock Island from mid-Tongass Narrows near the airport, looking south | 12 |
| Figure 7: Alternative G2 ferry from Lewis Point to Peninsula Point..... | 13 |
| Figure 8: Alternative G3 ferry from Clump Cove to Bar Point | 14 |
| Figure 9: Alternative G4 ferry from Gravina Island to Charcoal Point | 14 |
| Figure 10: Total Life-Time Cost of Each Alternative | 26 |
| Figure 11: Total Life-Time Costs by Alternative without and with Revenue Adjustment..... | 28 |

Tables

| | |
|---|----|
| Table 1: Construction, Life-Cycle, and Total-Life Costs (with and without revenue) | ii |
| Table 2: Average Daily Traffic Forecast | 4 |
| Table 3: Total 2040 ADT by Trip Purpose | 5 |
| Table 4: Annual M&O Costs..... | 17 |
| Table 5: Maintenance and Repairs, Frequency and Costs | 18 |
| Table 6: Major Structure Costs..... | 19 |
| Table 7: Ferry Facility Costs..... | 20 |
| Table 8: Right-of-Way Costs | 20 |
| Table 9: Total Construction Cost Estimate | 21 |
| Table 10: Life-Cycle Costs | 22 |
| Table 11: Anticipated Bridge Revenue with Tolling Options | 23 |
| Table 12: Anticipated Life-Time Costs..... | 25 |
| Table 13: Construction, Life-Cycle, and Total-Life Costs (without and with Revenue) | 27 |

Appendices

| |
|---|
| Appendix A, Tolling and Toll Plaza Technical Memorandum |
| Appendix B, Ferry Capacity Calculations Memorandum |
| Appendix C, M&O Cost Matrix |
| Appendix D, Construction Cost Matrix |
| Appendix E, Life-Cycle Cost Report |
| Appendix F, Cost of Ownership Summary |

1.0 INTRODUCTION

1.1 Purpose of this Report

The purpose of this *Construction Cost Estimate Report* is to present cost estimates for the reasonable alternatives to be considered in the Gravina Access Project SEIS. This report updates previous estimates prepared for the alternatives presented in the EIS, and includes revisions, modifications, and changes in the alternatives now identified as reasonable alternatives by the Department since the original ROD was signed in September 2004.

1.2 Project Background

The purpose of the Gravina Island Access is to improve transportation between Revillagigedo (Revilla) Island and Gravina Island, and to both encourage development and provide access to recreational lands on Gravina Island (see Figure 1). Revilla Island has steep mountainous terrain, and the majority of the developable flat land is currently occupied by residential, commercial and industrial land uses. However, expansion opportunities exist across the Tongass Narrows on the flatter Gravina and Pennock islands. Travel between the islands is possible by a ferry that primarily services the Ketchikan International Airport. Pennock Island is accessed by water taxi or private boat. The study area for possible crossing locations is about 8 miles long, from Peninsula Point near Ward Cove to northwest of Saxman, centered on Tongass Narrows.

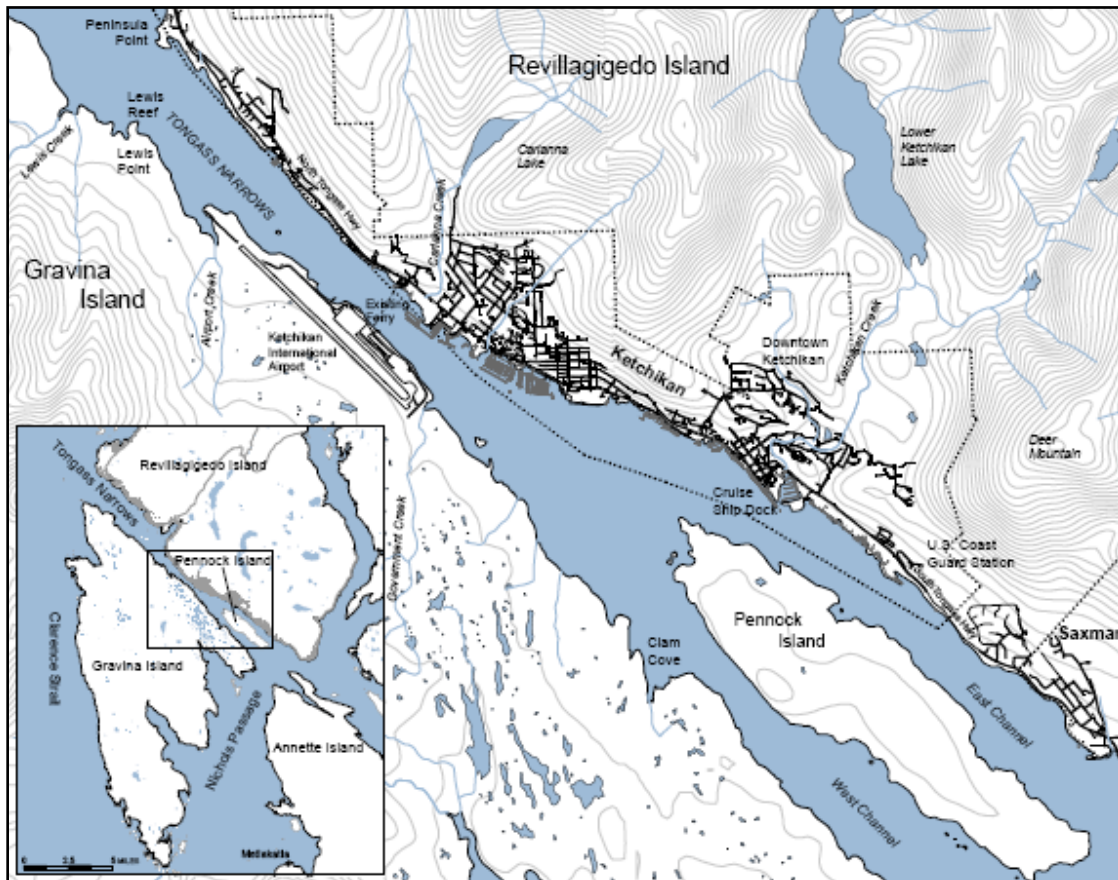

Figure 1: Gravina Island Access Vicinity Map

In 2004, the Department published an EIS that considered six bridge alternatives (C3a, C3b, C4, D1, F1, and F3), three ferry alternatives (G2, G3, and G4), and a No Action alternative to improve access between Revilla and Gravina islands. The ROD identified Alternative F1, which would cross Pennock Island and require bridges over East and West Channels, as the preferred alternative. In 2007, road construction commenced on Gravina Island as an initial phase of construction of Alternative F1 (Phase I). Subsequently, the Governor of Alaska directed the Department to cease further development of the F1 alternative and to look for the most fiscally responsible alternative for the Gravina Island Access; and in 2008, the Department and FHWA began work on the Gravina Access Project SEIS to identify whether a lower cost alternative could be found that was reasonable.

As part of this revised study, the original six bridge alternatives were supplemented with four more bridges (C3-4, F3v, M1, and M2) and a submerged tunnel (T1) crossing alternative. A more reduced scope ferry alternative (G4v) was added to the original three ferry alternatives. A passenger waiting terminal and baggage handling facilities at Charcoal Point, and a heavy freight dock and staging area on Gravina Island were incorporated into all the ferry alternatives. These costs were updated to 2008 dollars, and presented in the *Construction Cost Estimate Report of the Alternatives to be Considered in the SDEIS Screening Process*, July 31, 2009.

Subsequent to the study, the Department requested that all the build alternatives, regardless of mode, now include the replacement of the Airport Creek Bridge and the upgrade of the Seley Road to the northern airport boundary. The Department also requested that all of the ferry alternatives include replacement of the Ketchikan International Airport shuttle ferry lay-up berth.

The Department also recommended one small modification to the Alternative F3 alignment: the tangent after the last curve on Gravina Island was shifted to make better use of the existing Gravina Island Highway embankment that was constructed in 2007-08. This subtle change in centerline is identified herein as Alternative F3-1. (NOTE: for all other purposes, Alternatives F3 and F3-1 are the same.)

In early 2010, the Department produced the *Alternatives Screening Report* which identified the reasonable alternatives that would be evaluated in detail in the SEIS. These reasonable alternatives are two bridge alternatives -- C3-4 and F3, and four ferry alternatives -- G2, G3, G4, and G4v, in addition to the No Action alternative.

Additionally, direction was given to analyze the feasibility of charging tolls on the two bridge alternatives to help defray the maintenance and operational costs. This was submitted in the *Gravina Tolling and Toll Plaza Technical Memorandum*, September 29, 2010 (Appendix A).

This *Construction Cost Estimate Report* summarizes the costs for two bridge alternatives, four ferry alternatives, and the No Action Alternative, and updates costs to 2011.

2.0 DESIGN CONSIDERATIONS SUMMARY

The preliminary design criteria for the Gravina Access Project alternatives were developed during the EIS, and were formally presented for the preferred alternative, F1, in the *Design Study Report (DSR)*, which was approved by the Department on August 1, 2005.

During preparation of the EIS, cost estimates developed for bridge alternatives near the airport were based on limited design information. For the SEIS, the Department commissioned the *Construction Cost Estimate Report of the Alternatives to be Considered in the SDEIS Screening Process* in which greater effort was placed on the engineering of the alternatives; ie, location, design speed, profile grade, structure types and features, navigational clearance requirements, and other similar issues. These design considerations eventually evolved into a revised set of design criteria which were approved by the Department on August 27, 2010. These design criteria are relied upon in this construction cost update.

The design considerations can be briefly summarized in subsections 2.1 through 2.10.

2.1 Traffic Volumes

Revised traffic forecasts were prepared for the SEIS and are summarized in this section. The original 2002 traffic counts have been adjusted to 2010 based on a 1 percent population growth rate. The 1990-2000 Ketchikan growth rate was approximately 2 percent; however, the Alaska Department of Labor projection for 2010-2030 indicates a decrease of about 1 percent. The 1 percent growth rate is considered a reasonable projection for the 20-year planning horizon.

Visitor traffic to Ketchikan has also flattened (or even decreased) over the past couple of years as shown in Figure 2; but the cruise industry says that more cruise ships will be placed in service and that there will be more port calls to Southeast Alaska.

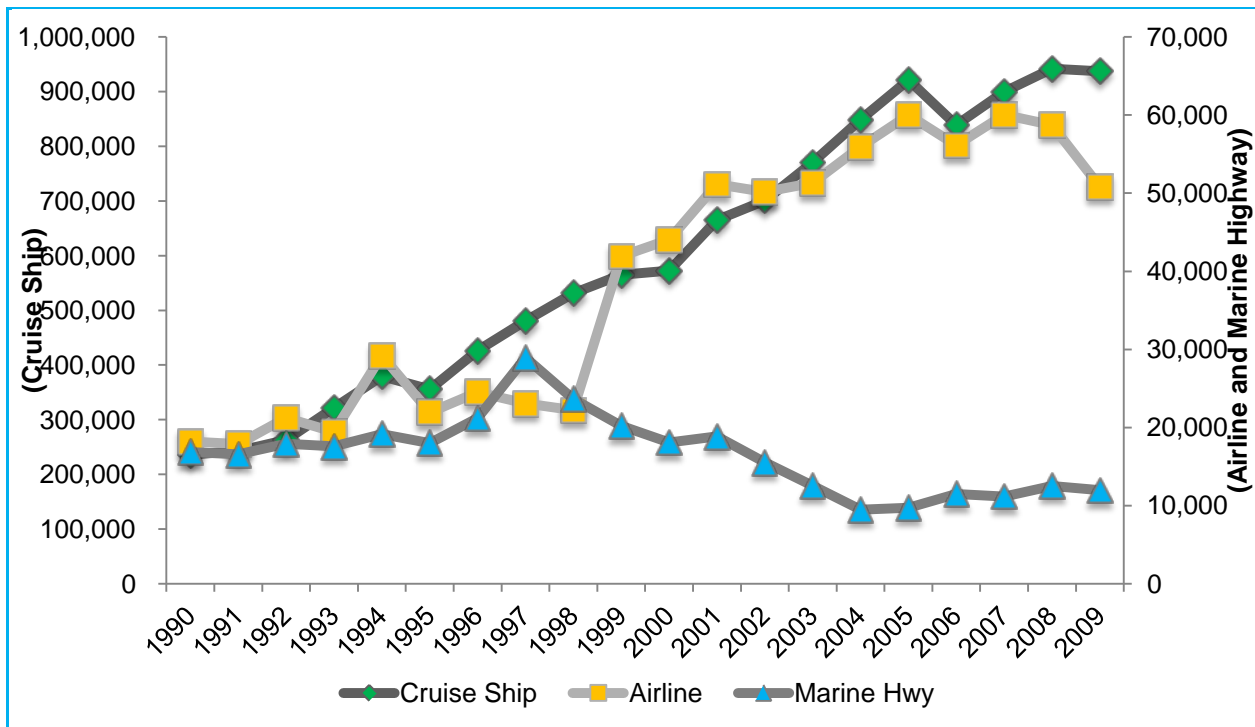

Figure 2: Visitor Traffic Trends

The traffic forecasts were developed for the bridge alternatives without and with a toll. Three toll options were considered for each bridge alternative: Option 1 assumed a rate similar to the current ferry service (\$5/adults and \$6/auto or light truck, or \$16 for a double occupancy vehicle), Option 2 assumed a flat rate of \$5, and Option 3 assumed \$2 per vehicle¹. In examining all of the different toll options, the Department considered the effect of tolling on traffic volumes.

For the ferry alternatives with new ferries and ferry terminals, the revised traffic forecasts, consistent with the 2004 Gravina Access Project FEIS, assumed that there is negligible difference in traffic flow between these ferry alternatives' location. Therefore, they were considered in one general "improved ferry alternative"². Alternative G4v would offer no additional transportation service; therefore, its traffic forecast is the same as the No Action. The original traffic projections were updated and adjusted for fares, and are presented in Table 2.

Table 2: Average Daily Traffic Forecast

| ALTERNATIVE | ADT Forecast* | | |
|---|---------------|-------|-------|
| | 2018 | 2030 | 2040 |
| C3-4 – Airport Bridge Access (No toll) | 995 | 2,500 | 2,611 |
| F3-1 – Pennock Island Bridge Access (No toll) | 1,012 | 2,597 | 2,730 |
| C3-4 – Toll Option 3 (\$2) | 961 | 2,284 | 2,388 |
| F3-1 – Toll Option 3 (\$2) | 977 | 2,373 | 2,495 |
| C3-4 – Toll Option 2 (\$5) | 943 | 1,469 | 1,606 |
| F3-1 – Toll Option 2 (\$5) | 957 | 1,584 | 1,749 |
| C3-4 – Toll Option 1 (\$16) | 879 | 1,268 | 1,369 |
| F3-1 – Toll Option 1 (\$16) | 883 | 1,350 | 1,471 |
| G2, G3, and G4 -- Improved Ferry Access | 256 | 278 | 282 |
| Existing Ferry Access (No Action and Alternative G4v) | 239 | 215 | 208 |

* DOT&PF Gravina Access Project SEIS Traffic Forecast Report, prepared by HDR, August 2012

Alternative F3-1 would encourage the most trips, mostly because it would create access to more land (Pennock Island), followed by Alternative C3-4, and then the ferry alternatives with additional ferries. The largest attractor is retail/commercial, residential development, and then air travel (see Table 3). As expected, the tolls result in a reduction in trips, with a greater trip decrease associated with increasing tolls. Without improved access, there is little encouragement for development on Gravina Island. Traffic projections for No Action and Alternative G4v, therefore, show a slight decline. Almost all development and elective trips cease at \$5; only those that have to go to Gravina Island will make the trip, regardless of the cost.

The total vehicle trips across Tongass Narrows in 2040, characterized by trip purpose, are presented in Table 3.

¹ DOT&PF Gravina Access Project SEIS Traffic Forecast Report, prepared by HDR, August 2012

² DOT&PF Gravina Access Project SEIS Traffic Forecast Report, prepared by HDR, August 2012

Table 3: Total 2040 ADT by Trip Purpose

| Trip Purpose* | Existing Ferry | Improved Ferry | No Toll | | Toll Option 3 (\$2) | | Toll Option 2 (\$5) | | Toll Option 1 (\$16) | |
|-------------------|----------------|----------------|-------------|-------------|---------------------|-------------|---------------------|--------------|----------------------|--------------|
| | | | C3-4 | F3-1 | C3-4 | F3-1 | C3-4 | F3-1 | C3-4 | F3-1 |
| Air Travel | 132 | 132 | 515 | 515 | 498 | 498 | 489 | 489 | 458 | 458 |
| Airport Business | 55 | 55 | 179 | 179 | 179 | 179 | 179 | 179 | 179 | 179 |
| Industrial | - | 6 | 154 | 154 | 187 | 187 | 181 | 181 | 157 | 157 |
| Retail/Commercial | - | - | 979 | 953 | 841 | 817 | - | - | -- | -- |
| Residential | 4 | 73 | 750 | 895 | 651 | 782 | 726 | 868 | 547 | 649 |
| Recreational | 15 | 15 | 31 | 31 | 30 | 30 | 29 | 29 | 27 | 27 |
| Tourism | 1 | 1 | 3 | 3 | 3 | 3 | 3 | 3 | 2 | 2 |
| TOTAL: | | 282 | 2611 | 2730 | 2389 | 2496 | 1,606 | 1,749 | 1,369 | 1,471 |

DOT&PF Gravina Access Project SEIS Traffic Forecast Report, August 2012

For a complete discussion of the forecast assumptions, methodologies, and results, see the Gravina Access Project SEIS Traffic Forecast Report, August 2012.

2.2 Typical Section

The access roadways for each alternative require a two-lane road based on the projected traffic counts. All new construction on Revilla Island would be 40-foot wide paved roads (12-foot lanes with 8-foot shoulders). Existing roads on Gravina Island would be improved, depending on their relationship to each alternative. The approach roads to the bridge structure(s) or the ferry terminals would be on paved, 40-foot wide facilities. Other roads or road segments would either remain as 36-foot wide gravel roads (Gravina Island Highway and Lewis Reef Road), or be widened to 36-foot wide gravel roads (Airport Access Road and Seley Road). All build alternatives include the replacement of the bridge structure over Airport Creek with a 36-foot wide single span concrete girder bridge (or 40-foot wide in the case of Alternative G2). The Tongass Narrows bridge(s) would include an 8-foot walkway.

The paved roadway typical section is shown in Figure 3.

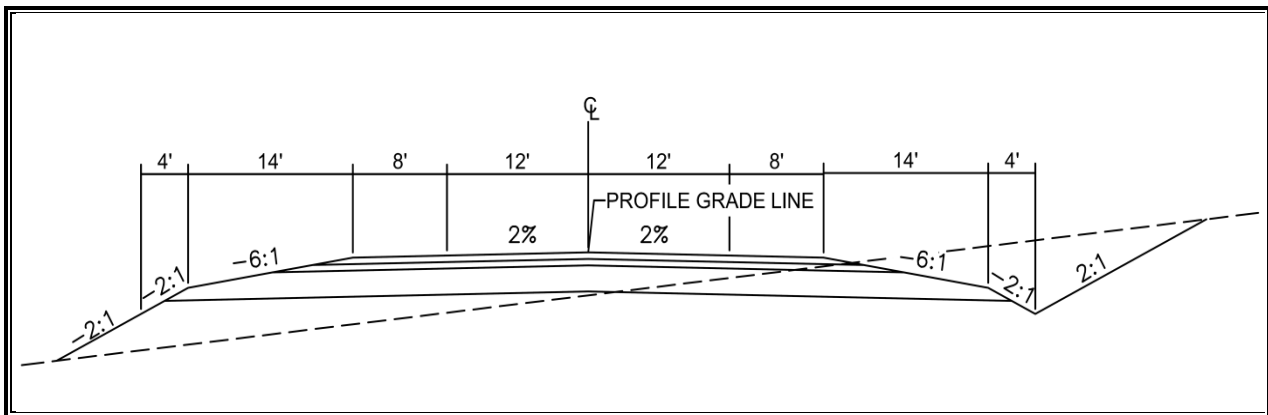

Figure 3: New Approach Roadway Typical Section

The 2005 DSR recommended acquisition in the rural area of a 300-foot wide, controlled-access corridor that would allow for frontage road access, utilities, and pathways in the future. In the urbanized area, a controlled-access right-of-way 100 feet wide should suffice, allowing for a two-lane urban roadway with provisions for future utilities and pedestrian facilities.

2.3 Design Speed

The design speed is 50 MPH for the roadways that traverse rural undeveloped lands, and a lower design speed within the urban developed street network. For the urban arterial segment, a design speed of 30 MPH would be consistent with the expected use. The roadways and structures crossing Tongass Narrows near the airport (C3-4, G4, and G4v) were designed as urban arterials with a design speed of 30 MPH; and the other crossings and Gravina Island roadways (F3-1, G2, and G3) were designed as rural highways with a design speed of 50 MPH³.

2.4 Profile Grade

Roadway grades considered in the design of the alternatives are consistent with AASHTO standards; ie, 7 to 11 percent, depending on the local terrain (mountainous), and location (rural or urban). For the most part, the grades associated with all the alternatives are less than 6 percent, except for both the existing short hill on Misty Marie Lane at WalMart (9%) and the approach to the Ketchikan International Airport (8%) on the Alternative C3-4 bridge. Both of these roads will require close monitoring during the winter months.

2.5 Navigational Clearances

The majority of the ships calling in Southeast Alaska in 2011 was in the 800 to almost 1,000 foot long range, and carried between 1,500 and 2,600 passengers⁴. For these vessels, the Gravina Access Project EIS established the minimum vertical clearance to the lowest bridge member for alternatives designed to allow cruise ship passage at 200 feet above Mean Higher High Water (MHHW) (200 feet above MHHW equals 200.9 feet above Mean High Water [MHW], 207.4 feet above Mean Sea Level [MSL], 213.9 feet above Mean Low Water [MLW], and 215.4 feet above Mean Lower Low Water [MLLW]). This height was derived using the vertical clearance of Lions Gate Bridge in Vancouver, BC. The vertical clearance at Seymour Narrows aerial cable crossing is 185 feet, but the cable could feasibly be raised to 200 feet, matching the vertical clearance of the Lions Gate Bridge. The largest vessels currently operating in Tongass Narrows have an average air draft of approximately 165 feet, and an average gross tonnage of about 71,000 tons. A small number of ships with air drafts in excess of 200 feet and gross tonnages exceeding 100,000 tons have made port calls in Ketchikan in the past, but no such vessels called at Ketchikan in 2011⁵. In 2005, when Ketchikan port calls reached an historic peak, less than 8 percent of the port calls were ships with air drafts in excess of 200 feet and registered gross tonnages exceeding 110,000 tons. The Alaska Marine Highway System (AMHS) ferries require a minimum vertical clearance of 120 feet above MHHW based upon the current Columbia-class ferries⁶.

The EIS also established horizontal navigational clearances, using 550 feet for one-way passage of cruise ships and 500 feet for two-way passage for AMHS ferries.

³ AASHTO *Policy on Geometric Design of Highways and Streets*, 2001, pages 474 and 448

⁴ Reference Juneau 2011 cruise ship schedule (http://www.traveljuneau.com/downloads/Cruise_Ship_Calendar.pdf)

⁵ Subsequent to a meeting with cruise ship pilots on June 14, 2010, the Department considered raising the minimum vertical clearance to accommodate the new Panamax ships that will have an air draft of almost 210-feet, and a requested new minimum height of 215-feet. Further review of the preliminary structure designs for Alternatives C3-4 and F3-1 suggest that possibly after construction, there may be 210-feet of vertical clearance, but during construction, there will only be 200-feet. A height of 215-feet may be tidally constrained, or mandate transit around Gravina Island.

⁶ Glosten *Reconnaissance of Vessel Navigation Requirements*, May 2003 (Gravina Access Project FEIS Appendix G)

Alternative F3-1 would require dredging of the West Channel to accommodate the deeper drafts for the cruise industry. Some of the ferry options would require minor dredging only near the docks to allow for maneuvering.

The Alternative F3-1 low bridge over the East Channel would be designed to allow barge traffic with a horizontal clearance of 350 feet and a vertical clearance of 60 feet above MHHW (for comparison, the middle 250 foot opening under the Gastineau Channel Bridge in Juneau is 51 feet high at MHW, about 50 feet at MHHW⁷. The Near Island Bridge in Kodiak has about 100 feet of vertical clearance, the clearance under the Japonski Bridge in Sitka is 50 feet at MHW, and the South Channel Bridge in Unalaska is 26½ feet above MHHW).

Preliminary engineering work confirms the need for pier protection for both bridge alternatives to protect both the structure and vessel in the event of an allision.

2.6 FAA Part 77

Within the study area is the Ketchikan International Airport (KTN), which includes a paved 7,500-foot long runway capable of landing jet aircraft in most weather conditions. The Federal Aviation Administration (FAA) code in Federal Aviation Regulation (FAR) Title 14, Part 77, *Objects Affecting Navigable Airspace*, regulates adjacent height restrictions for airport environs. New penetrations into this Part 77 airspace must be approved by the FAA prior to construction. Only bridge Alternative C3-4 across Tongass Narrows at the airport penetrates the FAA Part 77 airspace. The alignment for Alternative F3-1 is just outside these limits and, with a concrete box girder type structure, would have no impact on the approach.

2.7 USCG Lighting

Roadway lighting will be coordinated with the FAA, as required by the US Coast Guard's 33 CFR 118.45, *Lighting for the Protection of Aerial Navigation*, and with the airport. The USCG's 33 CFR 118.65(a), *Lights on Fixed Bridges*, will require the channel opening below the Gravina Island bridge to be marked with clearance lighting; green (center of the channel) and red (outer margins) navigational Fresnel lanterns.

2.8 Ferries

The Ketchikan Gateway Borough currently operates shuttle ferry service from Revilla Island to Gravina Island; the Department provides for the capital improvements. The EIS analyzed three ferry alternatives that would add ferry service at different locations:

- between Peninsula Point and Lewis Point (Alternative G2),
- near downtown at Bar Point to Clump Cove (Alternative G3), and
- adjacent to the existing service at Charcoal Point and the airport dock (Alternative G4).

Alternatives G2 and G3 are intended to be closer to populations north or south of the existing ferry crossing, and to provide service to Borough-owned lands for long-term economic development and recreation.

Under each ferry alternative, the existing shuttle ferry at the airport would continue to operate, resulting in a total of four ferry passenger/vehicle terminals (two under G4) and four ferries. The ferry terminals would have limited parking (with the exception of the Charcoal Point terminal which has a long-term and a large short-term parking lots), a ticket booth and passenger shelter, and electrical power.

⁷ NOAA Nautical Chart 17315 (<http://www.charts.noaa.gov/OnLineViewer/17315.shtml>)

All the ferry alternatives to be analyzed in the SEIS now include features not considered in the EIS. An enclosed 1500 square-foot 60 passenger waiting area with restrooms and enhanced baggage handling (two shuttle vans to carry both passengers and luggage) would be provided at Charcoal Point on Revilla Island for walk-ons to the passenger terminal at the airport. This location has the largest parking lot to accommodate people who want to leave their car (or are dropped off) and then walk to the airport; not many walkers, if any, are expected at either Peninsula Point or Bar Point, and therefore only minimal passenger waiting facilities are being provided at those locations. The cost of the Charcoal Point walk-on shuttle service would be included in the price of the ferry ticket.

The ferry alternatives also include a new heavy freight dock and $\frac{3}{4}$ -acre freight terminal on Gravina Island just south of the current airport ferry berth, to be capable of landing vessels and barges carrying bulk fuel or large heavy loads that cannot be accommodated on the smaller airport shuttle ferries. The new dock would also be able to tie up the larger AMHS vessels. Dock facilities that can accommodate the large loads are presently available only on Revilla Island (AMHS terminal facilities, Saxman Seaport, Alaska Marine Lines, and Northland Services).

Additionally, this project would replace the now closed lay-up dock (I-90 floating bridge remnant) with a new floating dock and transfer bridge to support lay over and maintenance of the airport shuttle ferries (see Figure 4).

It is assumed the ferry alternatives would continue to operate at current levels: 15-minute cycles during the summer and 30-minute cycles throughout the rest of the year. In order to provide improved service, all ferry alternatives except G4v are planned to operate 16 hours per day (two shifts), with four ferries during the summer peak demand, and two for the rest of the year.

2.9 Pedestrians

While not anticipated to be a high number, there are expected to be pedestrians and cyclists interested in crossing Tongass Narrows to Gravina Island. The majority of this volume would probably be tourists walking to mid-span of a bridge crossing for the view. The proposed major bridge structures (ie, crossing Tongass Narrows) include a pedestrian walkway. The ferries also accommodate walk-ons. There are no provisions for sidewalks or separated trails off the structures at this time. Pedestrians on other segments of the new alignment would use the shoulder of the roadway. The proposed right-of-way widths for all alternatives do accommodate a future pathway system.

2.10 Utilities

The bridge alternatives would not initially have utilities on them, but the utility companies could request space on these structures from the Department. They would need to identify their needs and design criteria. The Department is planning to reserve the outer edges of the right-of-way corridor for utilities and a pathway.



Figure 4: Waiting Area, Freight Dock and Lay-up Berth

3.0 REASONABLE ALTERNATIVES DESCRIBED

The following are the reasonable alternatives that will be evaluated in the SEIS and are included in this *Construction Cost Estimate Report* (see map on next page):

- **Alternative C3-4** -- bridge across Tongass Narrows between Bench (ByPass) Road near Signal Road and north of the airport terminal (200 foot vertical clearance)
- **Alternative F3-1** -- bridges across East and West Channels via Pennock Island (60 foot and 200 foot clearances, respectively) connecting South Tongass Highway to the airport terminal along the existing Gravina Island Highway and Airport Access Road
- **Alternative G2** -- new ferry service between Peninsula Point and Lewis Point, connecting North Tongass Highway with the airport terminal via Lewis Reef/Seley/Airport Access Roads
- **Alternative G3** -- new ferry service between downtown at Bar Point and Clump Cove, connecting downtown with the airport terminal via the existing Gravina Island Highway and Airport Access Road
- **Alternative G4** -- new ferry service between new terminals adjacent to the existing ferry terminals, connecting Charcoal Point with the airport terminal
- **Alternative G4v** -- a phase-constructed variant of Alternative G4
- **No Action Alternative** -- continued existing shuttle ferry service to the airport terminal

In addition to the construction cost estimates, the life-cycle and total-life costs were developed, with and without revenue adjustments to account for possible tolls. Descriptions of the alternatives are provided in the following paragraphs.

3.1 Alternative C3-4

Alternative C3-4 takes advantage of a long-planned Borough by-pass on the small topographic bench above the touchdown point on Revilla Island. A small refinement of Alternatives C3a or C4 using the proposed Bench Road to Rex Allen Drive/Misty Marie Lane/Signal Road near the WalMart parking lot rather than a large cut to North Tongass Highway would minimize costs of excavation and the curved structure on the eastern approach. The cruise ship trackline is assumed to be moved slightly to the east to match the AMHS trackline so the mainspan and backspans of the crossing would allow for the bridge to be constructed with segmental concrete box girders on tangent. With a 30 MPH design speed, the western curve associated with the Alternative C3a and C4 alignments is moved off the backspan. The curve at the transition pier and approach tangent on the west could then be constructed of 100 to 150 foot precast concrete deck bulb-T girders or even 200 foot spliced precast deck bulb-T girders.

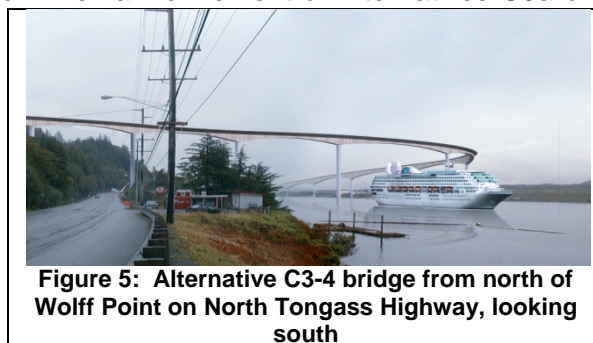
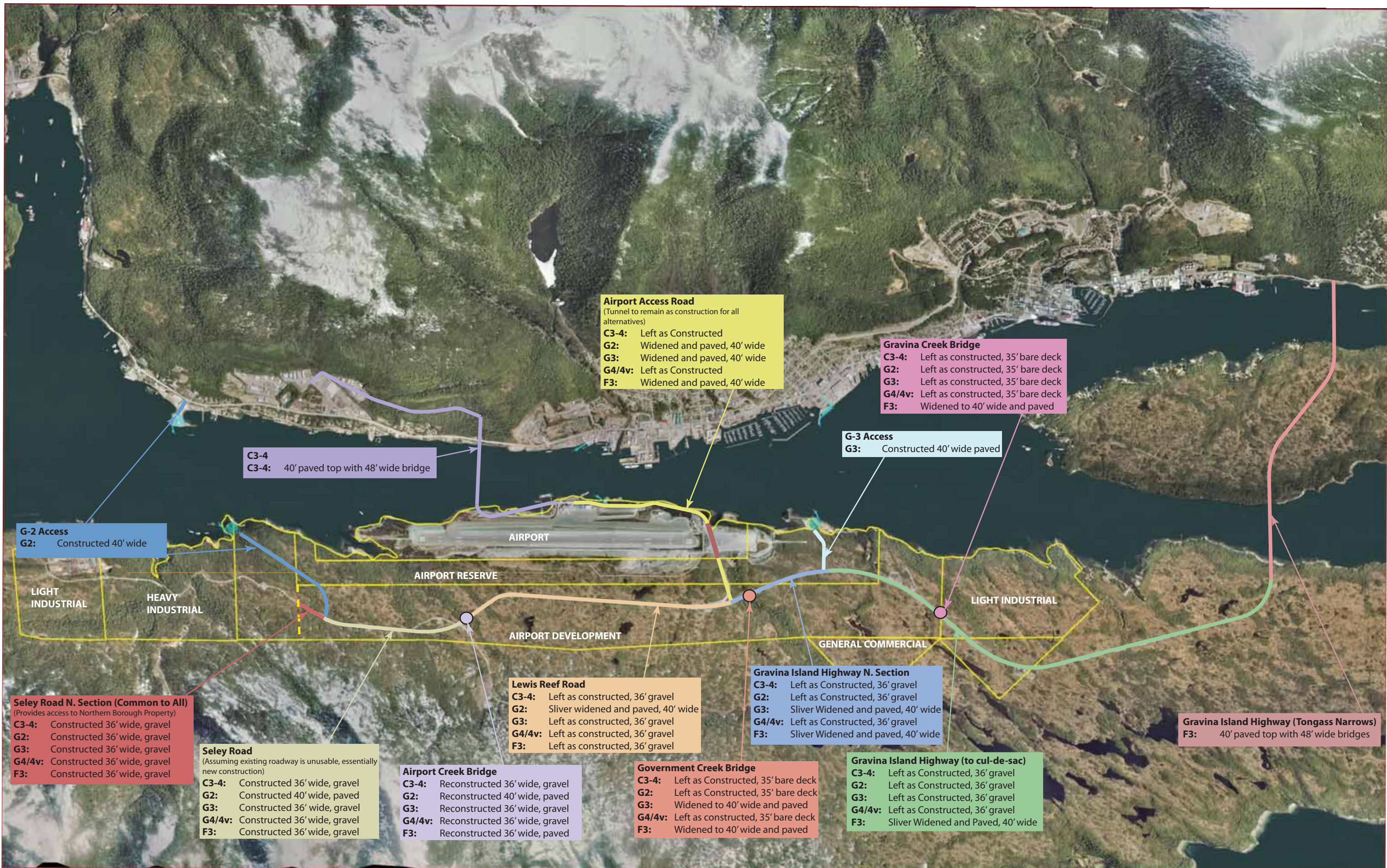

Figure 5: Alternative C3-4 bridge from north of Wolff Point on North Tongass Highway, looking south

Alternative C3-4 is 1.86 miles long with a structure length of 4,190 feet. The navigational opening would be minimum 200 feet high and at least 550 feet wide. The navigational opening within the main span would be located over water with depths in excess of 110 feet at MLLW.



Airport Access Road
 (Tunnel to remain as construction for all alternatives)
C3-4: Left as Constructed
G2: Widened and paved, 40' wide
G3: Widened and paved, 40' wide
G4/4v: Left as Constructed
F3: Widened and paved, 40' wide

Gravina Creek Bridge
C3-4: Left as constructed, 35' bare deck
G2: Left as constructed, 35' bare deck
G3: Left as constructed, 35' bare deck
G4/4v: Left as constructed, 35' bare deck
F3: Widened to 40' wide and paved

C3-4
C3-4: 40' paved top with 48' wide bridge

G-2 Access
G2: Constructed 40' wide

G-3 Access
G3: Constructed 40' wide paved

LIGHT INDUSTRIAL
 HEAVY INDUSTRIAL

AIRPORT RESERVE

AIRPORT DEVELOPMENT

GENERAL COMMERCIAL

LIGHT INDUSTRIAL

Seley Road N. Section (Common to All)
 (Provides access to Northern Borough Property)
C3-4: Constructed 36' wide, gravel
G2: Constructed 36' wide, gravel
G3: Constructed 36' wide, gravel
G4/4v: Constructed 36' wide, gravel
F3: Constructed 36' wide, gravel

Seley Road
 (Assuming existing roadway is unusable, essentially new construction)
C3-4: Constructed 36' wide, gravel
G2: Constructed 40' wide, paved
G3: Constructed 36' wide, gravel
G4/4v: Constructed 36' wide, gravel
F3: Constructed 36' wide, gravel

Lewis Reef Road
C3-4: Left as constructed, 36' gravel
G2: Sliver widened and paved, 40' wide
G3: Left as constructed, 36' gravel
G4/4v: Left as constructed, 36' gravel
F3: Left as constructed, 36' gravel

Airport Creek Bridge
C3-4: Reconstructed 36' wide, gravel
G2: Reconstructed 40' wide, paved
G3: Reconstructed 36' wide, gravel
G4/4v: Reconstructed 36' wide, gravel
F3: Reconstructed 36' wide, paved

Gravina Island Highway N. Section
C3-4: Left as Constructed, 36' gravel
G2: Left as Constructed, 36' gravel
G3: Sliver Widened and paved, 40' wide
G4/4v: Left as Constructed, 36' gravel
F3: Sliver Widened and paved, 40' wide

Government Creek Bridge
C3-4: Left as Constructed, 35' bare deck
G2: Left as Constructed, 35' bare deck
G3: Widened to 40' wide and paved
G4/4v: Left as constructed, 35' bare deck
F3: Widened to 40' wide and paved

Gravina Island Highway (to cul-de-sac)
C3-4: Left as Constructed, 36' gravel
G2: Left as Constructed, 36' gravel
G3: Left as Constructed, 36' gravel
G4/4v: Left as Constructed, 36' gravel
F3: Sliver Widened and Paved, 40' wide

Gravina Island Highway (Tongass Narrows)
F3: 40' paved top with 48' wide bridges

Due to the close proximity to the airport runway, the bridge is expected to penetrate the FAA Part 77 airspace (about elevation 290 feet actual vs 230.6 feet surface described). Since the surrounding topography already pierces significant portions of the Part 77 airspace, the infringement of the bridge is not expected to be a major issue with the FAA; and in fact, Alaska Airlines has stated that they would have no problem with the intrusion.

3.2 Alternative F3-1

Alternative F3-1 would have bridges that cross the two channels of Tongass Narrows via Pennock Island – with the higher bridge for the cruise ships over West Channel and a lower bridge suitable for barge traffic over East Channel. As noted earlier, Alternative F3-1 is identical to EIS Alternative F3, with the exception of a subtle engineering design change where the bridge alignment meets the Gravina Island Highway.

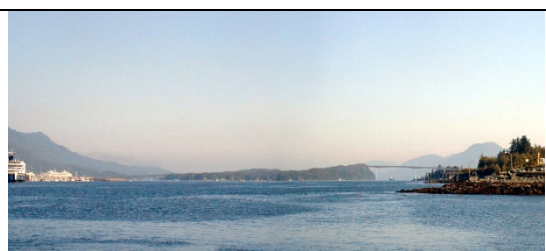

Figure 6: Alternative F3-1 bridges and Pennock Island from mid-Tongass Narrows near the airport, looking south

The West Channel bridge would be approximately 2,470 feet long and have a maximum height of about 270 feet. The bridge would have a minimum vertical navigational clearance of 200 feet above MHHW and a horizontal navigational clearance of approximately 550 feet. The bridge would be centered on and perpendicular to the AMHS trackline.

In order to improve its navigational characteristics for cruise ships transiting the West Channel, the narrowest portion of the channel under this alternative would be widened. Currently, the width of the navigable portion of West Channel, with respect to large cruise ships, is approximately 400 feet at its narrowest point with a minimum depth of 40 feet below MLLW. With the modifications, this portion of the channel would have a new channel width of 750 feet -- the center 550 feet would have a minimum depth of 40 feet below MLLW and both remaining sides would have a minimum depth of 30 feet below MLLW. The dredged quantity is approximately 213,000 cubic yards over 14.8 acres.

The East Channel bridge would be about 1,985 feet long and have a maximum height of approximately 115 feet. The bridge would have a minimum vertical navigational clearance of 60 feet above MHHW and a horizontal clearance of approximately 350 feet. The navigational opening would be perpendicular to the new trackline that would be about 445 feet west of the current cruise ship trackline. The main span would be located over water with depths in excess of 40 feet at MLLW. The primary users are anticipated to be fishing boats, and tug and barge transportation.

On Revilla Island, the East Channel bridge would connect directly to South Tongass Highway between the US Coast Guard Station and the Forest Park subdivision. From here, the bridge would rise across the East Channel and then traverse Pennock Island. From Pennock Island, the West Channel bridge would cross to Gravina Island and connect with the existing Gravina Island Highway. The Gravina Island Highway would be widened from 36 feet to 40 feet, and paved. The improved roadway would continue northward approximately 2.99 miles to its intersection with the Airport Access Road and Lewis Reef Road. The 1.15 mile widened and paved Airport Access Road then goes down the hill, under the runway and north along the Channel to the terminal. The total road distance between Revilla Island and the airport passenger terminal is 5.87 miles.

3.3 Alternative G2

Alternative G2 would be new ferry service that would complement the existing airport ferry for vehicles and passengers between Peninsula Point near Ward Cove on Revilla Island and Lewis

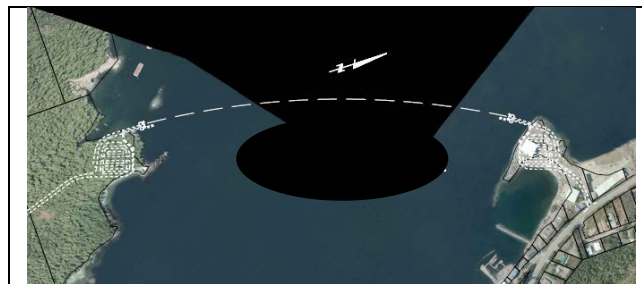

Figure 7: Alternative G2 ferry from Lewis Point to Peninsula Point

Point on Gravina Island, crossing Tongass Narrows approximately 2 miles north of the airport passenger terminal. The ferry crossing distance would be approximately three-quarters of a mile.

This alternative would require two new ferry vessels, as well as construction of a dock and small passenger terminal on each side of Tongass Narrows. The dredged quantity for both would be approximately 1,400 cubic yards over 0.2 acres. The terminals include

minimal parking and a combination ticket booth and passenger waiting area.

Additionally, this alternative includes a new passenger waiting terminal and enhanced baggage handling facilities at Charcoal Point on Revilla Island for walk-ons to the passenger terminal at the airport. It would also include a new ferry lay-up berth, and heavy freight terminal and staging area south of the existing ferry dock on Gravina Island.

A 0.8-mile long road would be constructed on Gravina Island to connect the ferry terminal at Lewis Point with Seley Road, which would be upgraded to meet the Lewis Reef Road. The Airport Access Road would be also upgraded. All these roads would be paved 40 feet wide. The total road distance between Lewis Point and the airport passenger terminal is 4.1 miles.

3.4 Alternative G3

Alternative G3 would be new ferry service that would complement the existing airport ferry for vehicles and passengers between Bar Point at Jefferson Street (near the Plaza Mall and downtown Ketchikan) on Revilla Island and a location approximately 1.3 miles south of the airport passenger terminal on Gravina Island near Clump Cove. The sailing distance would be approximately one-half mile.

This alternative would require two new ferry vessels and the construction of a new dock and passenger terminal on each side of Tongass Narrows. The existing breakwater would be widened and extended for use as the ferry terminal pier. It is not anticipated that the new terminal would interfere with the new development in the area. Dredging was also assumed to be required to provide adequate navigational depths for the ferry dock on Gravina Island, and possibly on Revilla Island; the quantity would be approximately 18,600 cubic yards over 2.14 acres.



Figure 8: Alternative G3 ferry from Clump Cove to Bar Point

Additionally, this alternative includes a new passenger waiting terminal and enhanced baggage handling facilities at Charcoal Point on Revilla Island for walk-ons to the passenger terminal at the airport. It would also include a new ferry lay-up berth, and heavy freight terminal and staging area south of the existing ferry dock on Gravina Island.

A 40 foot wide paved road would be constructed on Gravina Island from

the ferry terminal uphill past the new Runway 11/29 extension approximately 0.25 miles to the existing Gravina Island Highway, which currently connects to the airport. This segment of the Gravina Island Highway and the Airport Access Road would have to be widened and paved. The total road distance from Clump Cove to the airport passenger terminal is 1.9 miles.

3.5 Alternative G4

Alternative G4 would be providing new ferry service adjacent to the existing airport ferry route on a quarter-mile crossing of Tongass Narrows, 2.6 miles north of downtown. This alternative would require construction of two new docks (one on either side of Tongass Narrows), two new ferry vessels. The dock on Revilla Island would be parallel to the existing airport ferry dock, but the new dock on Gravina Island would be angled opposite of the existing dock so that development-bound traffic can enter and exit the ferry more conveniently. The total dredged quantity would be approximately 15,200 cubic yards over 1.22 acres.

This alternative includes a new passenger waiting terminal and enhanced baggage handling facilities at Charcoal Point on Revilla Island for walk-ons to the passenger terminal at the airport. It would also include a new ferry lay-up berth, and heavy freight terminal and staging area south of the existing ferry dock on Gravina Island.

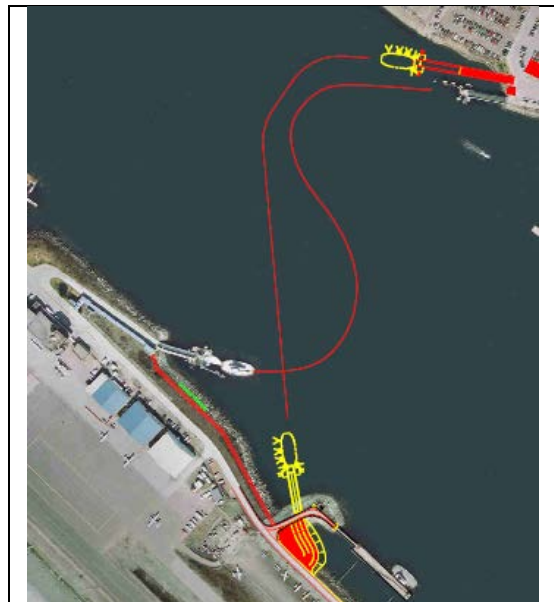

Figure 9: Alternative G4 ferry from Gravina Island to Charcoal Point

3.6 Alternative G4v

Similar to Alternative G4, Alternative G4v includes the addition of the passenger waiting facility and shuttle vans at Charcoal Point to carry pedestrians and their luggage to/from the airport terminal. It would also include a new ferry lay-up berth, and heavy freight terminal and staging area south of the existing ferry dock on Gravina Island. Unlike Alternative G4, no new docks or ferries would be constructed until ferry demand increases enough to necessitate it. When

demand approaches capacity of the existing system, the new docks and ferries associated with Alternative G4 would be constructed.

A ferry capacity analysis was performed based on Washington State Department of Transportation standards for determining level-of-service for ferry operation and a 1 percent population growth (see Appendix B). Based on that analysis, the demand-driven need for a new ferry would not occur until 2105. The life-cycle costs summary for Alternative G4v do not reflect new ferry docks or ferries during the 75 year study period⁸.

3.7 No Action Alternative

The No Action Alternative consists of continued operation of the existing ferry on the present schedule. Although there are no initial construction costs, a 75-year life-cycle cost estimate was developed for the No Action Alternative based on operation and maintenance costs. Ferry replacement every 35 years and maintenance of the Gravina Island Highway and the Airport Access, Lewis Reef, and Seley Roads to the airport reserve boundary are included in those costs.

3.8 Features Common to All the Alternatives

Each alternative includes maintenance of:

- The gravel Gravina Island Highway to the southern airport reserve boundary, for a total length of approximately 3.2 miles (except for Alternative G3 at 2.6 miles);
- The gravel Lewis Reef and Seley Roads to the northern airport reserve boundary, for a total length of approximately 2.2 miles; and
- The Airport Access Road, which extends from the airport terminal, passes beneath the runway safety area in a tunnel, and then climbs the hill to its intersection with the Gravina Island Highway and Lewis Reef Road, a distance of approximately 1.15 miles.

All build alternatives include the construction of a replacement to the existing unpaved single-lane bridge over *Airport Creek* at the end of Lewis Reef Road. The upgraded bridge would be 36 feet wide to provide gravel access to the northern developable lands, except under Alternative G2 where the roadway and bridge would be paved to 40 feet wide.

The construction cost estimates do not include a vehicle parking facility at the airport terminal. The funding source for such a facility is anticipated to be FAA rather than FHWA; therefore it is not incorporated. This is a change from the EIS.

⁸ For comparison purposes, HDR calculated life-cycle costs associated with Alternative G4v assuming a demand-driven need for one new ferry and corresponding docks in 35 years. These costs are provided in Appendix C.

4.0 MAINTENANCE AND OPERATIONS COSTS

Ongoing maintenance costs are a major consideration by the Department since all revenues to operate public facilities are funded using State general funds, with no federal assistance. The Department seeks measures to minimize costs with efficient infrastructure whenever possible. The Borough is currently responsible for the maintenance and operations (M&O) of the airport shuttle ferries under an operational agreement with the Department, but the Department funds the capital improvements. The recurring costs are the annual maintenance expenses for the structures, roadways, and ferry system. Periodic costs are repairs, improvements and replacements that can be expected over the life of the facility, regardless of funding source.

4.1 Bridges

Bridge structures not only have annual routine maintenance that includes drainage system cleaning and repairs, bridge deck patching, restriping, and snow removal, but also require the cleaning of expansion joints, repairs to railings, and painting of metal parts. More substantial periodic bridge maintenance expenses include pavement overlays of the wearing course, replacement of signs and illumination, changing of damaged bridge railings, expansion joint gland renewal, and occasionally replacing the whole modular expansion joint assembly. Also, bridge and underwater foundation inspections are accounted for in these expenses; a biennial above-water structure inspection, and an underwater inspection that occurs every 5 years.

4.2 Roadways

Routine roadway maintenance costs typically include drainage control, brush clearing, and snow removal, expressed as a per lane-mile (L-M)⁹ expense. For paved roads, this also includes restriping and possibly pothole patching; and for gravel roads there would be constant grading of the driving surface – due to the rolling nature of Gravina Island, washboarding of the gravel surface is expected. In Southeast Alaska, this cost to the Department is approximately \$5,000 to \$6,500/L-M for paved and for gravel roads. Additionally, it is assumed the paved road would need an overlay about every 10 years, and gravel roads may need to be resurfaced with more crushed base material every few years.

Due to their exposure to the environment, signing and luminaire poles have a limited life span, and it is assumed this whole system would be replaced about every 15 years on average. Guardrail is another element that endures high wear and tear, especially during the winter season. To account for this, the estimates include replacing 50 percent of the roadway railing every 5 years. These costs have been developed on a per foot basis to be used on the various lengths for each alternative.

4.3 Ferries and Docks

Ferry and dock annual maintenance costs are based on the estimates prepared for the EIS inflated to 2011 dollars. Above and underwater inspections similar to bridge inspections are required. Periodic maintenance costs for the docks (for anode replacement, fendering repairs, recoating, etc) and ferry replacement costs (\$8 million every 35 years) were also included.

⁹ A lane-mile is defined as the width of a mile of roadway divided by 12; therefore there are 3.33 lane-miles on one mile of 40-foot wide roadway.

4.4 Annual M&O Costs

Table 4 summarizes the expected annual maintenance and operational costs for each alternative. Costs from the 2004 EIS are presented for comparison purposes.

Table 4: Annual M&O Costs

| ALTERNATIVE | Cost (EIS-2004)¹⁰ | Cost (2011) |
|--------------------|---|------------------------|
| C3-4 | -- | \$ 244 K |
| F3-1 | \$ 110 K | 188 K |
| G2 | 5 M | 5.87 M |
| G3 | 5 M | 5.86 M |
| G4 | 5 M | 5.85 M |
| G4v | -- | 3.57 M |
| No-Build | 2 M | 3.55 M |

A summary of the major categories of maintenance costs anticipated and the frequency of those costs is presented in Table 5:

¹⁰ Gravina Access Project Final Environmental Impact Statement, July 30, 2004, pages 2-2, 2-3

Table 5: Maintenance and Repairs, Frequency and Costs

| EXPENSE | CYCLE (yrs) | ESTIMATED COST |
|---|-------------|--------------------------|
| Normal and Routine Maintenance | | |
| Annual bridge maintenance costs (w/o road cost) | 1 | \$ 1,500/L-M (\$1.14/LF) |
| Annual paved road maintenance costs | 1 | 5,000/L-M (\$4.29/LF) |
| Annual gravel road maintenance costs | 1 | 6,500/L-M (\$4.29/LF) |
| Annual ferry and dock maintenance costs (G2 and G3) | 1 | 5.71 M |
| Annual ferry and dock maintenance costs (G4) | 1 | 5.70 M |
| Annual ferry and dock maintenance costs (no-build G4v) | 1 | 3.42 M |
| Periodic Repairs | | |
| Above ground structure (bridge/dock/tunnel) inspections | 2 | \$ 40,000 |
| Underwater foundations (bridge/tunnel) inspections | 5 | 40,000 |
| Underwater foundations (dock) inspections | 5 | 25,000 |
| Fendering system repairs | 5 | 50,000 |
| Guardrail replacement | 5 | 117/LF |
| Bridge rail replacement | 5 | 23/LF |
| Pavement planing and overlay | 10 | 102/LF |
| Heavy freight dock resurfacing | 10 | 400,000 |
| Anode replacement (bridge) | 10 | 100,000 |
| Anode replacement (ferry dock) | 10 | 20,000 |
| Anode replacement (heavy freight dock) | 10 | 100,000 |
| Neoprene gland expansion joint replacement | 10 | 500,000 |
| Signing and illumination replacement | 15 | 5/LF |
| Recoat transfer span | 15 | 150,000 |
| Bridge support-float recoat | 15 | 75,000 |
| Expansion joint assembly replacement | 25 | 1,400,000 |
| Ferry replacement costs | 35 | 8,000,000 |
| Ferry terminal mooring structure replacement | 35 | 1,500,000 |
| Transfer bridge replacement costs | 75 | 2,000,000 |
| | | |

These values were used to develop the life-cycle costs examined in Chapter 6. See Appendix C for a full breakdown of maintenance and operational costs.

5.0 CONSTRUCTION COST ESTIMATE

The costs of the bridge alternatives presented in the 2004 EIS were derived from a preliminary cost estimate for preferred Alternative F1 and per-square-foot unit costs applied to the other bridge alternatives (F3, C3a, C3b, C4, and D1). The EIS cost estimates were updated for the 2005 DSR for Alternative F1, and the other alternatives were updated similarly. For this *Construction Cost Estimate Report*, costs for Alternative F1, including features such as piers, deck, and other elements were updated to 2008 dollars, and then the individual feature costs (ie, cost of foundation in deep water, foundation in shallow water, long span box girder, etc) were applied to Alternatives C3-4 and F3-1 to develop improved cost estimates those alternatives. Construction costs for the bridge and ferry alternatives to be evaluated in the SEIS were then updated to 2011 dollars. Details of the construction cost estimate are provided in Appendix D.

5.1 Bridge Structure

Table 6 provides the cost comparison of the major bridge structures of Alternatives C3-4 and F3-1.

Table 6: Major Structure Costs

| ALTERNATIVE | Cost (EIS-2004) | Cost (2011) |
|-------------|-----------------|-------------|
| C3-4 | -- | \$ 153 M |
| F3-1 | \$ 99 M | 171 M |

The 2008 estimates for structures were adjusted to account for the change in construction costs. Materials made up approximately one-third of the costs (equipment and labor are the remainder), and this was adjusted to 2011 dollars the FHWA's *National Highway Construction Cost Index* (NHCCI)¹¹.

These costs are for the major bridges over Tongass Narrows only; they do not include the new Airport Creek Bridge (\$1 Million), or the widening of the Government or Gravina Creek bridges (\$1 Million total) under Alternative F3-1. The cost of widening and deepening the West Channel for improved navigation under Alternative F3-1 is \$13 Million.

5.2 Roads

The estimated roadway costs for each alternative were developed with roadway quantities prepared from 2002 aerial photography. Updated unit prices were extrapolated from the Southeast Region's *Bid Tabs* from 2003 through 2010 for the larger projects of similar type work in the Panhandle. Each pay item cost was adjusted to 2011 dollars using the FHWA NHCCI.

5.3 Ferry Facilities

The costs of the ferry alternatives presented in the EIS assumed new ferries would be similar to the existing vessels, and new shelter/ticket booths and terminals would be constructed at each shoreline terminus. The costs also included the expenses for dredging at the docks. For this effort, the 2004 costs were only adjusted for inflation to 2011 dollars using the FHWA NHCCI. As discussed earlier, all the ferry alternatives now include costs for passenger waiting and

¹¹ FHWA *National Highway Construction Cost Index* (<http://www.fhwa.dot.gov/policyinformation/nhcci.cfm> and <http://www.fhwa.dot.gov/ohim/nhcci/pt1.xls>)

enhanced baggage handling facilities for the existing Charcoal Point ferry terminal on Revilla Island; and a single heavy freight dock and staging area, and replacement ferry lay-up berth near the airport. Costs for these facilities were provided by the Department. Updated ferry facility costs are summarized on Table 7.

Table 7: Ferry Facility Costs

| ITEM | Cost (EIS-2004) | Cost (2011) |
|----------------------------|-----------------|-------------|
| Ferry and Docks (G2) | \$ 34.2 M | \$ 34.9 M |
| Ferry and Docks (G3) | 34.4 M | 35.3 M |
| Ferry and Docks (G4) | 32.8 M | 33.5 M |
| Ferry and Docks (G4v)* | -- | 0.0 M |
| Passenger Baggage Handling | -- | 1.4 M |
| Heavy Freight Terminal | -- | 5.4 M |
| Ferry Lay-up Berth | -- | 6.0 M |

*There are no new ferries or docks in the initial construction

5.4 Right-of-Way

The controlled-access right-of-way costs were determined by overlaying the slope limits on the Ketchikan Gateway Borough's property tax maps and assuming total acquisition for the majority of the parcels (some of the larger parcels not requiring a total take were assigned a percentage right-of-way cost commensurate with the percentage of the parcel needing to be acquired), and then computing a value based on each parcel's 2008 Borough tax-assessed values; currently, there appears to be no significant change in values. Publically-owned parcels were assumed to be obtained at no cost. The ferry alternatives assume a lump sum acquisition cost. Table 8 summarizes right-of-way costs for each alternative.

Table 8: Right-of-Way Costs

| ALTERNATIVE | Cost (EIS-2004) | Cost (2011) |
|-------------|-----------------|-------------|
| C3-4 | -- | 3.8 M |
| F3-1 | 0.05 M | 0.3 M |
| G2 | 1.0 M | 1.0 M |
| G3 | 4.1 M* | 1.0 M |
| G4 | 0.4 M | 0.5 M |
| G4v | -- | 0.5 M |

*Alternative G3 anticipated more on-shore property acquisition at Bar Point in 2004; whereas in 2011, more fill adjacent to current development for the terminal is planned

Based upon recent aerial photography, it is evident that there have been expansions of the quarry off Tongass Avenue and new structures are being built in the Cambria Drive and Jefferson Street areas. These recent developments could increase right-of-way acquisition costs of Alternatives C3-4 or G3. New development is on-going in Ketchikan, and the alignment of the selected alternative would be adjusted in final design to avoid or minimize impacts to the extent practicable.

5.5 Design and Construction Costs

Construction estimates are used for initial build costs, and include contingencies (15% for roadway and 20% for bridges) and 5 percent for construction administration. Developmental costs are assumed to be 7 percent of the construction amount (2% for environmental/permitting and 5% for design phases). A lump sum cost was assessed for existing utility relocation. Additionally, an annualized average ICAP (departmental overhead charge) of 5 percent was computed on the total costs.

5.6 Total Construction Costs

The construction costs (direct payments to the contractor), construction administration (cost of inspection and acceptance), developmental costs (environmental and design), utility relocation and right-of-way acquisition for the studied alternatives are summarized in Table 9.

Table 9: Total Construction Cost Estimate

| ALTERNATIVE | COST (2011) | | | | | |
|-------------|--------------|-----------------------------|---------------|--------------------|--------------------------|-----------|
| | Construction | Construction Administration | Developmental | Utility Relocation | Right-of-Way Acquisition | ICAP |
| C3-4 | \$ 185 M | \$ 9.3 M | \$ 13.6 M | \$ 1.0 M | \$ 3.8 M | \$ 10.6 M |
| F3-1 | 234 M | 11.7 M | 17.2 M | 0.1 M | 0.3 M | 13.2 M |
| G2 | 67 M | 3.4 M | 4.9 M | 1.0 M | 1.0 M | 3.9 M |
| G3 | 58 M | 2.9 M | 4.2 M | 1.0 M | 1.0 M | 3.3 M |
| G4 | 51 M | 2.6 M | 3.8 M | 1.0 M | 0.5 M | 3.0 M |
| G4v | 18 M | 0.9 M | 1.3 M | 1.0 M | 0.5 M | 1.1 M |
| No Action | 0 M | | | | | |

Developmental expenses are those costs after ATP with engineering, and include the costs of the completing the design, possible updating of environmental documents, obtaining resource permits, etc. The costs for utility relocation and right-of-way acquisition are included within their respective budget items.

6.0 LIFE-CYCLE COSTS

A life-cycle cost is defined as the overall estimated cost of a single alternative over a defined period. The *Intermodal Surface Transportation Efficiency Act of 1991* (ISTEA) required the consideration of life-cycle cost analysis in the design of pavements and bridges. *Safe, Accountable, Flexible, Efficient Transportation Equity Act -- A Legacy for Users* (SAFETEA-LU) of 2005 requires the application of value engineering methods, including the analysis of life-cycle costs, to bridge projects with an estimated total cost of \$20 million or more.

All of the expenses associated with an alternative that occur during its life are used to calculate the life-cycle cost. For the Gravina Access Project, present worth¹² is used to compare the life-cycle costs of different crossing concepts. To compute the life-cycle costs, the initial construction costs, annual maintenance and operational costs, and the more substantive periodic maintenance/repair costs are estimated and forecasted for the life span of the project, including the year in which they are anticipated to occur. Taking into account inflation and discount rates, a present value is calculated. This was accomplished using the costing software for bridges, *BridgeLCC*, by the National Institute of Standards and Technology (NIST), as recommended by the FHWA (<http://www.fhwa.dot.gov/infrastructure/asstgmt/lcca.cfm>). The inflation rate used is 3.77 percent (<http://www.usinflationcalculator.com/inflation/current-inflation-rates> or <http://www.rateinflation.com/inflation-rate/usa-inflation-rate.php>), the real discount rate used is 2.3 percent, and the nominal discount rate used is 4.2 percent (http://www.whitehouse.gov/omb/circulars/a094/a94_appx-c).

The life-cycle costs for all alternatives were computed in 2011 dollars. The term of the analysis is 75 years to correspond with the design life of the bridges, as required by the FHWA. Assuming construction would be completed in 2015, the final cost would occur at the end of 2090. Each of the maintenance items occurs at its respective frequency as depicted in Table 4, starting in 2015. The analysis assumes the proposed bridges have an expected life of 75 years, and 35 years for the ferries. At the end of their life span, the bridge or ferry may be rehabilitated or salvaged and replaced by a new facility. For this analysis, the salvage value at 75 years was assumed to be the cost of demolition and disposal, and therefore established as zero dollars.

Table 10 summarizes the anticipated life-cycle costs, without revenue adjustment, for the SEIS alternatives. The *Life-Cycle Cost Reports* are shown in Appendix E.

Table 10: Life-Cycle Costs

| ALTERNATIVE | 2004 EIS (20-Year Life-Cycle) | 2011 (75-Year Life-Cycle) |
|-------------|----------------------------------|------------------------------|
| C3-4 | -- | \$ 222 M |
| F3-1 | \$ 170 M | 286 M |
| G2 | 90 M | 331 M |
| G3 | 100 M | 314 M |
| G4 | 90 M | 301 M |
| G4v | -- | 182 M |
| No Action | 13 M | 88 M |

¹² The value now, if one were to start a savings account, of a series of future payments, discounted to reflect the time value of money.

7.0 TOLLS

In 2009, the Department requested an analysis of the feasibility of charging tolls on the two bridge alternatives to defray the maintenance and operation (M&O) costs of the project and possibly some of the construction costs.¹³ The types of toll facilities that could be used with the bridge alternatives were explored in the *Gravina Tolling and Toll Plaza Technical Memorandum*, dated November 18, 2011 (Appendix A).

For the bridge alternatives, revenue was determined for the three toll options using corresponding traffic projections. Fares would only be charged in one direction (outbound from Gravina Island), and no distinction would be made for classification of vehicle (the percent trucks is anticipated to be very small). Table 11 characterizes the range of projected revenue from the bridge alternatives.

Table 11: Projected Bridge Revenue with Tolling Options

| ALTERNATIVE | TOLL AMOUNT | 2018 ADT | 2018 Revenue | 2030 ADT | 2030 Revenue | 2040 ADT | 2040 Revenue |
|-----------------|-------------|----------|--------------|----------|--------------|----------|--------------|
| C3-4 with Tolls | \$2 | 961 | \$ 0.35 M | 2,284 | \$ 0.83 M | 2,388 | \$ 0.87 M |
| | \$5 | 943 | 0.86 M | 1,469 | 1.34 M | 1,606 | 1.47 M |
| | \$16 | 879 | 2.57 M | 1,268 | 3.70 M | 1,369 | 4.00 M |
| F3-1 with Tolls | \$2 | 977 | 0.36 M | 2,373 | 0.87 M | 2,495 | 0.91 M |
| | \$5 | 957 | 0.87 M | 1,584 | 1.45 M | 1,749 | 1.60 M |
| | \$16 | 883 | 2.58 M | 1,350 | 3.94 M | 1,471 | 4.30 M |

The averaged annual bridge and approach road M&O expenses are approximately \$250,000 for Alternative C3-4 and \$200,000 for Alternative F3-1 (see Table 4).

Based on the projected toll revenues in Table 11, a \$2 toll at bridge opening in 2018 would cover annual M&O costs for Alternatives C3-4 and F3-1. Remaining revenues could be set aside to help defray construction costs. Higher toll values would result in higher revenues, which would increase the amount available to pay off construction costs; however, as toll values increase, the number of trips across the bridge decreases.

The initial cost of tolling is approximately \$85,000 for electronic toll collection. If manual toll collection facilities were used, the cost would be \$250,000 for two toll booths and an additional lane (in the outbound direction) for Alternative C3-4 and \$150,000 for F3-1. Annual M&O costs for electronic tolling are about \$150,000, whereas manned booths have M&O costs of approximately \$1 million. Because of their lower costs, the cost estimate assumed electronic toll collection facilities would be used for the bridge alternatives.

For the existing ferry alternatives (G4v and No Action), the annualized revenue was estimated based on averaged historical annual income to date of \$1.5 Million. For the enhanced ferry alternatives (G2, G3 and G4), the annual revenues were prorated based upon the anticipated traffic growth described in the Gravina Access Project SEIS Cost Benefit Analysis, August 2012¹⁴; resulting in annual income of \$2.0 Million (see Table 12). These revenues only partially cover the M&O cost (see Table 4).

¹³ Memorandum from Leo von Scheben, Commissioner, DOT&PF, to Gary L. Davis, Southeast Regional Director, DOT&PF, September 17, 2009.

¹⁴ *Gravina Access Project SEIS Cost Benefit Analysis*, August 2012, page 15.

Table 12: Anticipated Ferry Revenue

| ALTERNATIVE | EXPECTED 2033 TRAFFIC DEMAND | ANTICIPATED ANNUAL REVENUE |
|--------------------|-------------------------------------|-----------------------------------|
| G4v and No Action | 208 | \$ 1.5 M |
| G2, G3 and G4 | 282 | 2.0 M |

8.0 TOTAL LIFE-TIME COSTS

Another helpful way of looking at the costs for this project is the summation of the annual expenses and revenue, over the life-time of the facility – in this case 75 years. If all the costs were inflated over time (2.3% Forward Inflation Rate¹⁵) and then added up, regardless of funding source, it would give a true picture of the total monetary value (no present value) of each alternative -- the cost of ownership. These figures represent the sum of the estimated annual budget appropriations (inflation adjusted) required to fund the particular alternative over the facilities' lifespan.

Table 13 is a summary of the total life-time costs of the alternatives, without and with expected revenue. For purposes of this analysis, the annualized incomes of the alternatives were estimated to \$250,000 for Alternative C3-4, \$200,000 for Alternative F3-1, \$1.5 Million for the existing ferry alternatives, and \$2.0 Million for the enhanced ferry alternatives.

Table 13: Anticipated Total Life-Time Costs

| ALTERNATIVE | TOTAL LIFE-TIME COSTS | TOTAL REVENUE | ADJUSTED TOTAL LIFE-TIME COSTS |
|-------------|-----------------------|---------------|--------------------------------|
| C3-4 | \$ 391 M | \$ 56 M | \$ 335 M |
| F3-1 | 576 M | 45 M | 531 M |
| G2 | 1,330 M | 451 M | 879 M |
| G3 | 1,262 M | 451 M | 811 M |
| G4 | 1,207 M | 451 M | 756 M |
| G4v | 1,050 M | 338 M | 712 M |
| No Action | 929 M | 339 M | 590 M |

The total life-time costs can also be viewed over time to see how the costs accrue. In this case, the costs of the bridge alternatives are highest, but over time, the costs of the ferry alternatives exceed the costs of the bridge alternatives. This can be attributed to labor and maintenance costs over time (see Summary in Appendix H).

¹⁵ CBO *The Budget and Economic Outlook: An Update*, August 2011, Table B-1 (<http://www.cbo.gov/ftpdocs/123xx/doc12316/08-24-BudgetEconUpdate.pdf>)

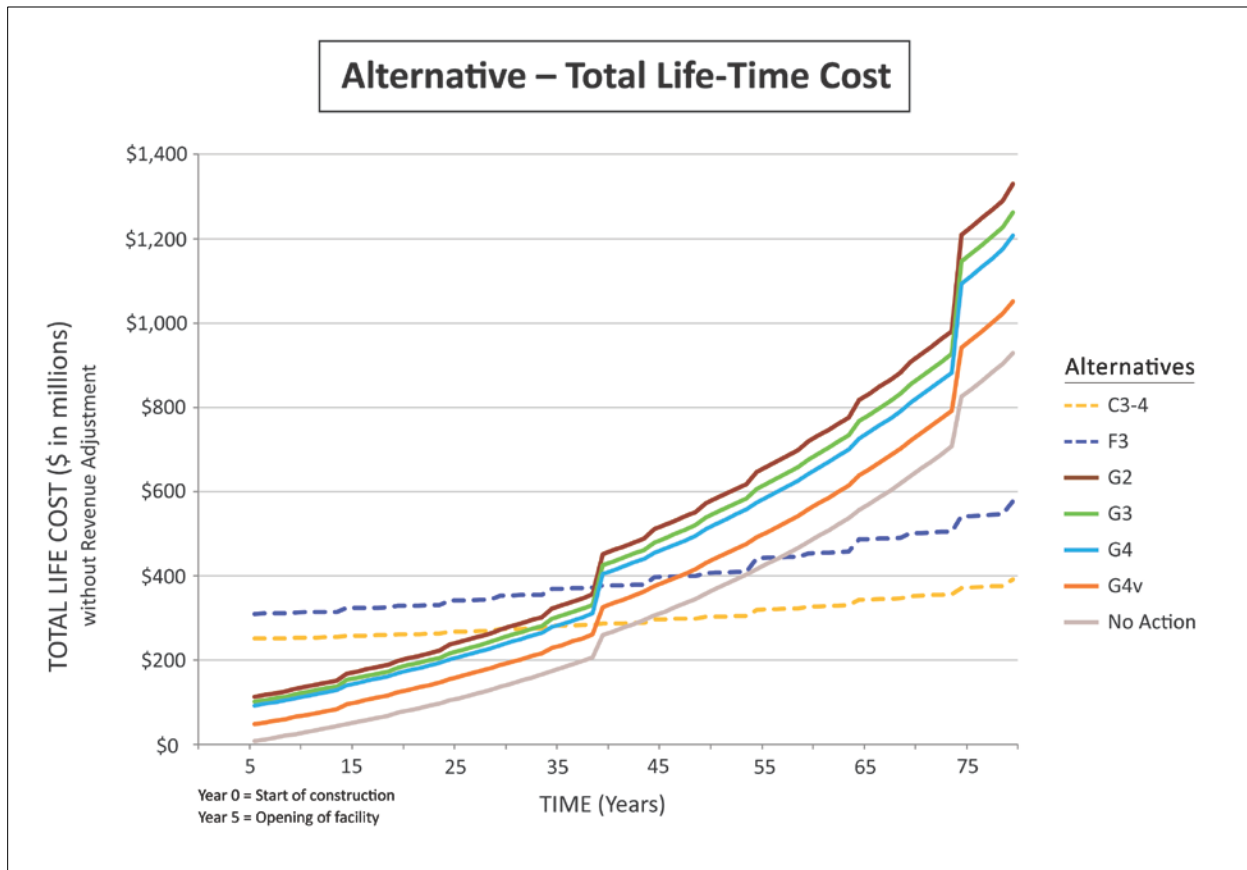

Figure 10: Total Life-Time Cost of Each Alternative

The two step jumps for the ferry alternatives are the purchases of a replacement ferry every 35 years (note that for comparison purposes, Alternative G4v also assumes a demand-driven need for one new ferry).

9.0 CONCLUSION

The report provides an estimate of construction and related costs for the Gravina Access Project alternatives for comparison purposes. These cost estimates are not to be viewed as actual construction costs. As more design information is developed or the alternatives are modified, the estimates would be adjusted accordingly.

The bridge alternatives have high initial construction costs, ranging from about \$220 million to over \$275 million, and they also have high life-cycle costs due to their high initial costs.

The ferry alternatives have lower initial costs, varying up to just over \$80 million; but their high annual operating costs and periodic repairs/replacements elevate their life-cycle costs substantially.

No user costs were incorporated into these estimates; life-cycle costs represent only the owner's costs.

For operations where fare or toll revenue would be received, the annualized incomes were subsequently estimated, and the life-cycle costs were then adjusted.

Finally, the total costs for the bridges and ferries were calculated to determine what the actual costs over time would be at the 75-year design life.

Table 14 summarizes these results.

Table 14: Construction, Life-Cycle, and Total Life-time Costs (without and with Revenue)

| Alternative | Construction Cost | Life-Cycle Cost | Life-Cycle Cost (revenue adjusted) | Total Life-Time Cost | Total Life-Time Cost (revenue adjusted) |
|-------------|-------------------|-----------------|------------------------------------|----------------------|---|
| C3-4 | \$ 223 M | \$ 222 M | \$ 214 M | \$ 391 M | \$ 335 M |
| F3-1 | 276 M | 286 M | 280 M | 576 M | 531 M |
| G2 | 81 M | 331 M | 265 M | 1,330 M | 879 M |
| G3 | 70 M | 314 M | 247 M | 1,262 M | 811 M |
| G4 | 62 M | 301 M | 234 M | 1,207 M | 756 M |
| G4v | 23 M | 182 M | 132 M | 1,050 M | 712 M |
| No Action | 0 M | 88 M | 35 M | 929 M | 590 M |

Note: Costs are in 2011 dollars

For clarification, the reason that the life-cycle cost for Alternative C3-4 is less than the construction cost (and the same is true for other alternatives too, although it is not as obvious) is that the construction amount is "paid" 5 years out at the end of construction. For comparison, the life-cycle cost for Alternative C3-4 in the Table above would be \$232 Million at the construction mid-year, and \$242 Million if paid in year 1.

The total life-time cost for each alternative, both without and with the toll revenue adjustment, is shown below on Figure 11:

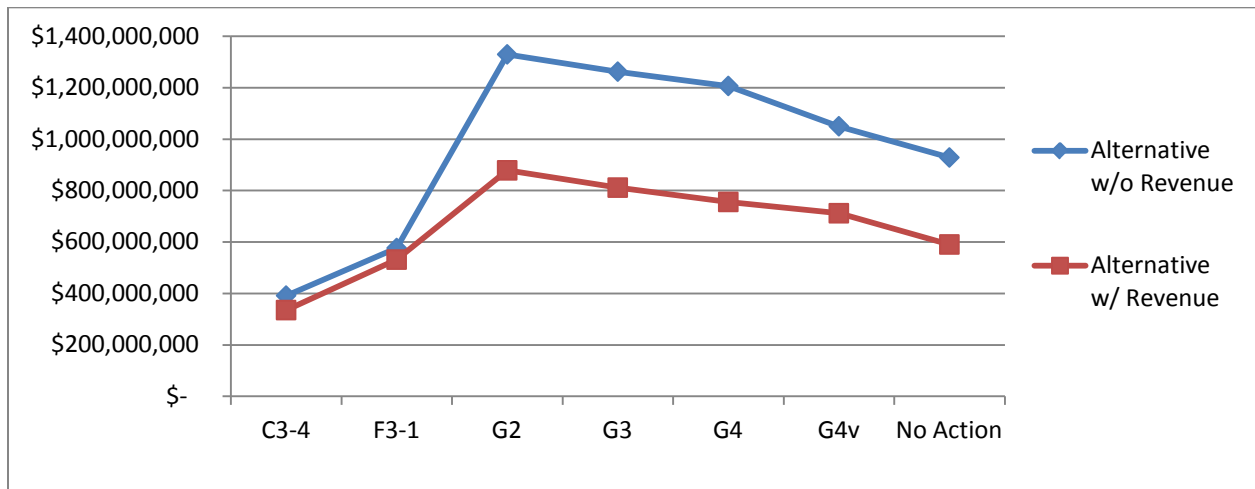

Figure 11: Total Life-Time Costs by Alternative without and with Revenue Adjustment

Appendix A

TOLLING and TOLL PLAZA TECHNICAL MEMORANDUM

Date November 18, 2011
To File
From Michael R. Tooley
Senior Transportation Engineer
Project Gravina Island Bridge Access
HP-NCPD-922(5) / 67698



Subject Tolling and Toll Plaza Technical Memorandum

At the request of the Department, *HDR Alaska* investigated the feasibility of converting the current bridge crossing alternative at the Airport (C3-4) and across Pennock Island (F3-1) into revenue-generating facilities (C3-4t and F3-1t). Per instructions from the Department, any acceptable procedure for collecting tolls was open for review, but they recommended only tolling in one direction.

TOLL COLLECTION. Tolling can be accomplished by either manned collection booths, or non-stop automatic electronic toll collection (similar to *Good to Go!* in Washington, *FasTrak* in California, or the *E-ZPass* system used in the Northeast from Maine to Virginia).

Infrastructure for manned collections consists of embankment widening for the toll plaza, one or more booths, and the necessary utilities (heat, power, phone/cable, restroom, etc) to operate the system. It is assumed that the office would be located at the existing State maintenance yard at Peninsula Point on Revilla Island.

The electronic toll collection (ETC) operates continuously. It consists of specialized technologies including either a transponder or a radio frequency identification (RFID) system, vehicle classification system (if required), reader(s), and a transaction processing system. The RFID system places a tag on the vehicle and a reader pole or bridge at the plaza to count the number of trips. The information is sent electronically to an office for processing and billing, presumably located at Peninsula Point.



Figure 1, Electronic Toll Collection Plaza Layout

It may be that since there are not that many large truck-type vehicles¹, it would be more efficient to just have one all-inclusive class of vehicle, and that a vehicle classification system would not be required.

Typically, the RFID tags are rented with a nominal refundable deposit. Accounts with an initial balance are set up that the tolls are billed against. Credit card accounts usually do not require a balance, and sometimes the tag deposit requirement is waived. Since Ketchikan is a small community on a "closed" roadway system, an RFID tag for each car, truck and motorcycle should not be an insurmountable problem (local peer pressure will probably preclude scofflaws). It is possible to legislate that all the vehicles in the greater Ketchikan area be tagged (similar to the recently eliminated emissions requirements in Anchorage and Fairbanks). What few tourists that do drive the Ketchikan roadways could be informed to rent a one-week tag, or since they arrived on the AMHS ferry, it could be an included surcharge when the Department issues their travel ticket.

Violation enforcement for either system consists of automatic license plate recognition cameras that take pictures of the vehicle's plate. The information is then processed, and a citation is sent to the registered owner. Plate recognition can also be used for payment; a user can pass through, have their plate identified, and then call into the office and pay their fee (and administrative cost) within an allotted period of time (after which it becomes a violation).

DESIGN CRITERIA. If the tolls are manually collected at a plaza with booths, it is believed that one booth would be open all the time, and one booth would be provided for peak hour traffic and when the primary booth was receiving maintenance. The booth would be a heated enclosure, no larger than 6x10 feet; comfortable enough for an operator and a computer/cash register.

With the C3-4 design speed of 30 MPH, the posted speed limit would probably be 25 MPH across the bridge, and the average running speed would be about 20 MPH. With shy distance offsets of 2 feet each side of the booth, and a taper rate of speed to 1 (20:1), the alignment shift would occur over 200 feet $((2 + 6 + 2) \times 20 = 200)$. The total toll plaza dimensions would be about 70 x 850 feet. All widening will occur off the bridge so that there would be no changes in the structural members.

With the F3-1 alignment, the design speed is, and the speed limit would probably be, 50 MPH across Pennock Island. However, with a toll plaza, the posted speed limit and running speed would probably be closer to 20 MPH, so the total toll plaza dimensions would be essentially the same as Alternative C3-4t. All widening will happen between

¹ *Project Design Designations*, approved initially on August 23, 2004; updated and approved on July 27, 2005; and updated and approved again on August 27, 2010, all predict 2 percent commercial trucks (ADT \approx 50).

the opening in the controlled-access and the bridge so that no changes in the structure would be necessary.

If tolls are electronically collected, then no booths or plaza widening would be required. A pole-mounted reader however, would be required in each direction to keep people from swerving into the opposite lane to avoid being billed.

LOCATION. Next a preferable location was investigated; either on the Revilla Island side or on the Gravina Island side for alignment C3-4t, and quickly decided that the Revilla side roadway was too short to provide for the necessary widening for booths between the intersection of the Bench (ByPass) Road and the bridge abutment (about 200 feet).



Figure 2, West Abutment at Intersection of Gravina Island Access and Bench Road

There is an additional concern when the Bench Road is ultimately continued southerly around town as the possibility of queuing of cars could back up onto this roadway. When the road is eventually extended towards Ketchikan, there may need to then be extra lanes installed for the backup of vehicles.

Another location would be on the Gravina Island side where there is a little more room to construct a toll plaza. It is still a very tight site, at the base of a steep hill with a lot of driver distractions coming into view at the Airport terminal. The distance between the bridge abutment and the terminal intersection is about 400 feet, adequate room for a merging lane. The access roadway down to the shuttle ferry ramp would need to be

filled in order to accommodate an extra booth, but the ferry dock was going to be removed at the completion of this project anyway.

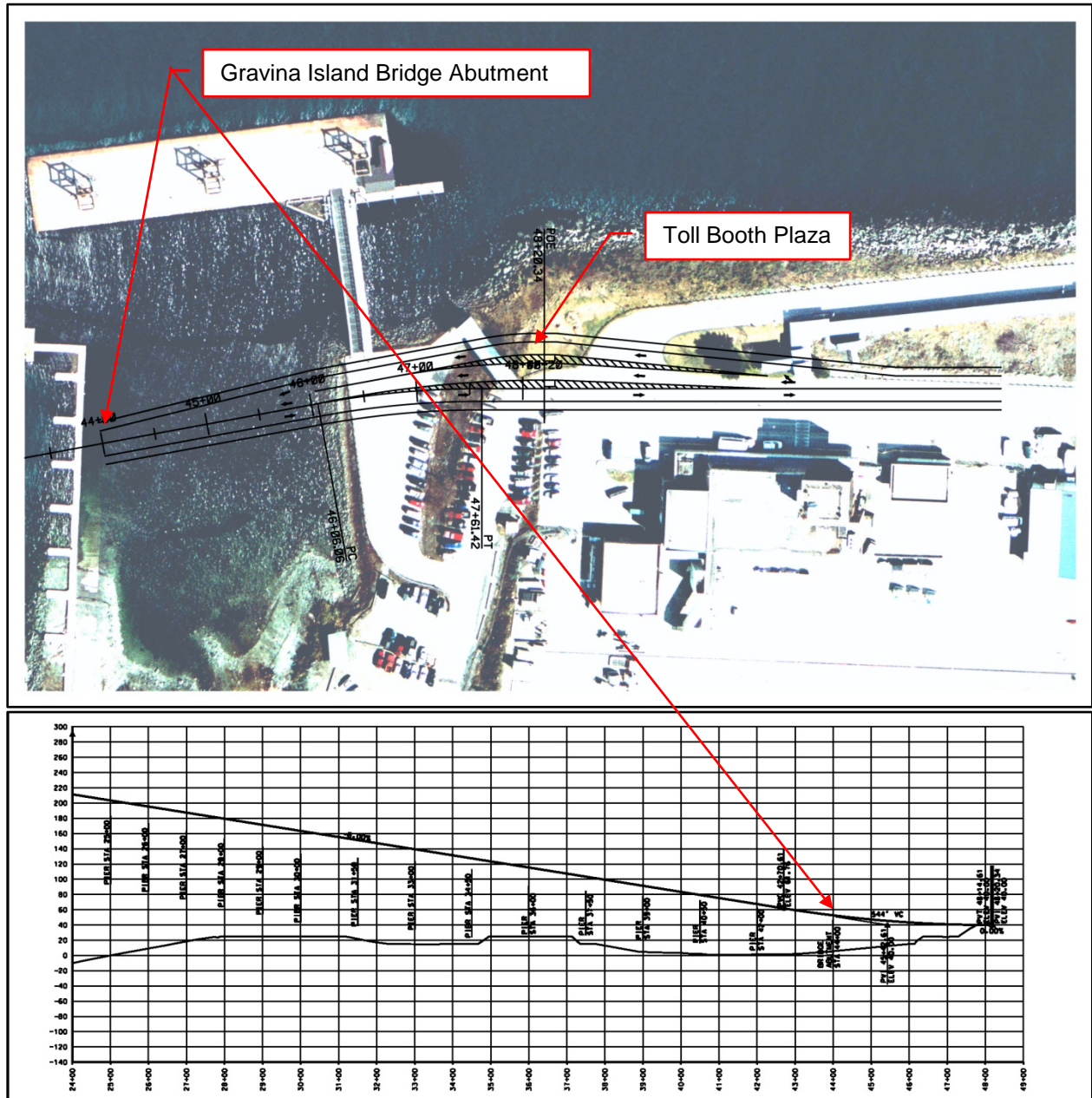

Figure 3, East Abutment and Airport Access Road at Airport Terminal

The lane arrangement adjacent to the terminal would need to be modified, as would the intersection that accesses the terminal parking, relocated seaplane area, and perimeter road to the west of the toll booths; but these are relatively minor changes. The new intersection would be just beyond the plaza to the south, in front of the terminal building.

An outbound direction (towards Revilla Island) was selected because of the proximity to the existing airport facilities, and the steepness of the bridge grade approaching Gravina Island (-8%). With the plaza on essentially level ground; after paying, vehicles can then start their climb up and over to Revilla Island rather than trying to slow or stop as they approach the plaza from the bridge grade.

These concerns would not be an issue if electronic collection was implemented; the readers could be installed anywhere up to the bridge abutment, or even on the bridge, thereby eliminating the stop-and-go congestion in front of the terminal.

If the F3-1t alignment was selected, the toll plaza should be located immediately after (east of) the only controlled-access opening (Sta 346+50) on Pennock Island. The terrain is essentially level, and there is sufficient room to construct the plaza before the curved approach to the East Channel bridge abutment. And as before, the tolls would be collected on the outbound traffic returning to Revilla Island.

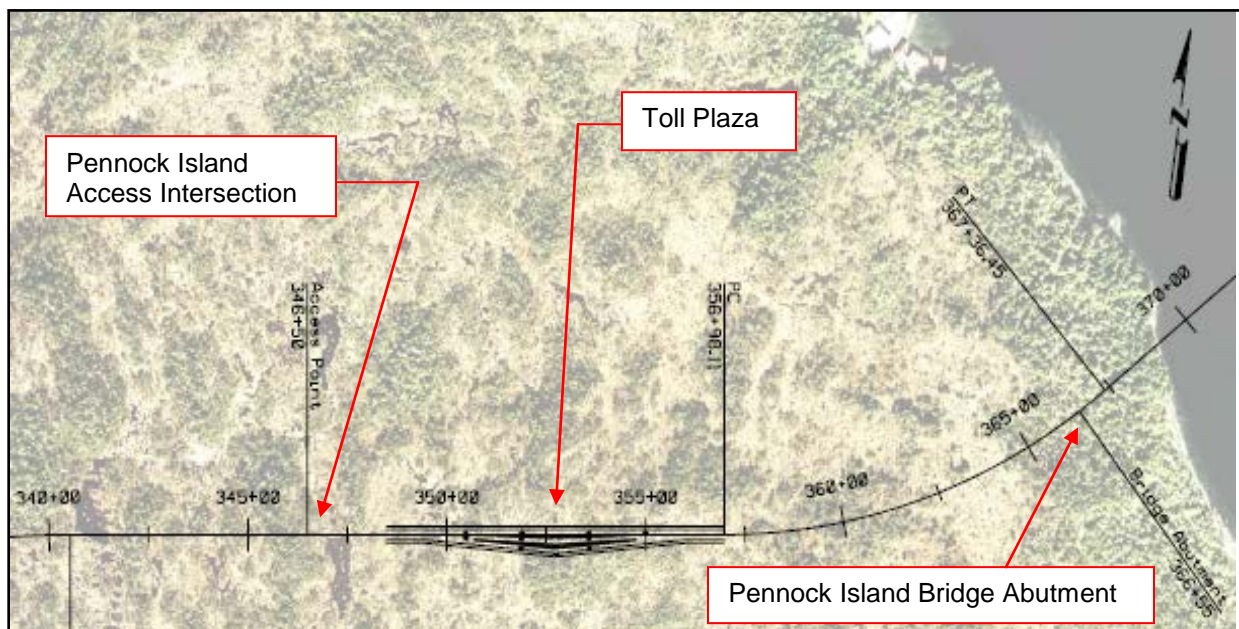

Figure 4, *Pennock Island Toll Plaza*

The one drawback to this location is that traffic commuting to/from Pennock Island with a destination of Gravina Island would be making their trip without charges. If the toll station was placed west of the intersection, then the potentially heavier Pennock-Revilla traffic would travel for free. Eventually, an additional plaza may have to be provided if outbound Pennock Island traffic increases significantly.

With automatic electronic toll collection, the readers would be placed just east of the controlled-access opening, again for both lanes. With two more readers and a more sophisticated setup, readings could be taken on both sides of the Pennock Island

intersection and the individual RFID identification numbers would be compared to identify and bill new travelers.

CONSTRUCTION COSTS. It is anticipated that the cost for widening the embankment into *Tongass Narrows* would be approximately \$150,000 (10,000CY @ \$15) for C3-4t, and about half that, \$75,000, for F3-1t widening on Pennock Island. Paving and signing would add another \$20,000. Both toll booths for each location would run about \$60,000 (@ \$120/SF). With contingencies, say the total cost for the manned toll plaza would be approximately \$250,000 for C3-4t and \$150,000 for F3-1t.

The costs for the electronic system are approximately:

Table 1, ETC Estimated Costs

| DESCRIPTION | QUANTITY | TOTAL COST |
|---|----------|------------------|
| Cantilever support pole for single lane | 2 | \$ 40,000 |
| ETC reader | 2 | 20,000 |
| Enforcement camera | 2 | 10,000 |
| ETC communications interface and antennae | 1 | 10,000 |
| Office processing system | 1 | 5,000 |
| TOTAL: | | \$ 85,000 |
| RFID tag deposit | each | ≈ \$ 25 |

The costs for the automated toll collection would be about \$25 for each vehicle tag (there are about 14,400 registered motor vehicles in Ketchikan²). Initial installation costs for the collection system is on the order of about \$100,000.

MAINTENANCE COSTS. Manned booths that either collect cash or tokens must be physically occupied during the designated time of operation, ie; 24 hours per day year round; or it could be set up that tolling is only collected from 6am until 10pm (similar to the current ferry operation 6:15am to 9:30pm) – two complete 8-hour shifts – with the late evening shift being free under the assumption that little revenue would be collected in the middle of the night.

With around-the-clock manned tolling, it is anticipated that there would need to be a permanent staff of about eight (8) people -- one employee all the time, and one more employee for a second operation during the peak hours (4 people per 24 hour day). Assuming that this is 32 hours per day (24 + 8 = 32), the needed coverage is about 12,000 hours per year. A normal State shift year consists of almost 2,000 hours, or about six (6) people necessary to cover the operation. Add in one person extra for vacations and sick leave and one supervisor in the office managing staffing and the funds, and a minimum staffing for toll operations of eight (8) employees would be required. This would be about \$840,000 per year (buffered rate at \$35/hour), or say \$1

² Alaska DOA Division of Motor Vehicles, 2009 (<http://doa.alaska.gov/dmv/research/curreg09.htm>)

million with incidentals. These costs do not envision an unmanned late evening shift with the road being open for free.

The main drawback to the collection booth system for a small community, is that proposed staffing would far outweigh the cost of the electronic counting system. A staffer is still necessary for billing and collection of the fares on the electronic system, and to also process any “run through” violators (run-throughs are identified on the video enforcement system).

One full-time employee responsible for the billing and collection would cost about \$100,000 per year.

Normal and routine yearly maintenance for either the booths or the electronic system would probably add another \$50,000 to the annual costs.

The life-cycle costs for the toll booths are almost seven times the cost of the electronic collection (\$35 million vs \$5 million) over the 75 year design life, due mostly to the high investment in labor.

ESTIMATED REVENUE. The design usage of the bridged connection over *Tongass Narrows* is estimated at 2,500 vehicles per day for the Airport crossing, and 2,600 vehicles for the Pennock Island crossing without fees. If we assume that a toll operation would reduce the anticipated daily usage in the design year (2030) proportionately in the amount of the toll, the following counts³ and revenue stream can be expected:

Table 2, Estimate Annual Gross Revenue

| OPTION | TOLL | 2030 ADT | ANNUAL GROSS REVENUE (million) |
|-------------------------------|------|----------|--------------------------------|
| Airport Access (C3-4t) | Free | 2,500 | \$ 0.00 |
| | \$2 | 2,270 | \$ 0.83 |
| | \$5 | 1,454 | \$ 1.33 |
| | \$16 | 1,264 | \$ 3.69 |
| Pennock Island Access (F3-1t) | Free | 2,598 | \$ 0.00 |
| | \$2 | 2,368 | \$ 0.86 |
| | \$5 | 1,575 | \$ 1.44 |
| | \$16 | 1,339 | \$ 3.91 |

On average, the tolling operation could expect to collect from almost \$1 to just over \$3½ million per year over the expected life, regardless of the alignment; the \$2 toll is expected to be the “break-even” amount where the annual maintenance and operations expenses for the bridge and approach roadways (\$250,000 for C3-4 and \$200,000 for

³ HDR iTrans (draft) *Gravina Island Access Project Updated Traffic Forecast*, October 2011

F3-1) are expected to be balanced by the revenues in the opening year. The estimated revenue generation and user benefits are discussed in greater detail in the *Cost-Benefit Analysis of Gravina Access Project Alternatives* technical memorandum dated November 2011.

RECOMMENDATION. When comparing the user time delays between toll booth and electronic fare collection systems, especially with the poor location of the plaza at the base of the steep grade on the Airport crossing (C3-4), or the potential lost revenues of an unmanned late evening shift, or even the Pennock Island crossing gap, the electronic toll collection system makes the most sense. When evaluating the life-cycle costs, as expected, it is more cost effective selecting the electronic system. It is therefore recommended that electronic toll collection be implemented.

Appendix B

FERRY CAPACITY CALCULATION MEMORANDUM



Memorandum

To: Carol Snead – HDR
Cc:
From: Allison Clavelle, EIT
Kate Halverson, EIT
Date: August 27, 2010
Re: **Ferry Capacity Calculations**

1. INTRODUCTION

As part of the assessment of Alternative G4v for the Gravina Access Project Supplemental Environmental Impact Statement (SEIS), the project team requires an understanding of when investment in a new ferry is required. The need for a new ferry is predicated on the maximum capacity of the existing service. This memorandum outlines the current operating frequency and capacity of the existing airport ferry service as well as the recommended level of ridership where an additional ferry may be required.

2. FREQUENCY AND CAPACITY OF EXISTING FERRY SERVICE

Ketchikan currently has two ferries (Main and Secondary) providing service to Ketchikan International Airport and Gravina Island. The following outlines the capacity and service frequency of these two ferries.

Main Ferry Capacity:

- 150 People (including 2 crew members) when there are no vehicles
- 100 People (including 2 crew members) and up to 22 passenger cars

Secondary Ferry Capacity:

- 100 people (including 2 crew members) when there are no vehicles
- 80 people (including 2 crew members) and up to 15 passenger cars

In the summer (first week of June to first week of September):

- Main Ferry runs every day – 6:15 a.m. to 9:30 p.m. twice an hour
- Secondary Ferry runs Mon-Fri 8:00 a.m. to 3:45 p.m. twice an hour (opposite the Main Ferry)

In the winter:

- Only the Main Ferry runs every day – 6:15 p.m. to 9:30 p.m. twice an hour
- Sometimes adjust the times based on Alaska airlines schedule

3. LEVEL OF SERVICE FOR FERRIES

The capacity of a ferry service is dependent on the number of vehicles and passengers that can be accommodated in one sailing and the number of sailings per day. During busy times, ferries may run at or above capacity, with some vehicles and passengers waiting for a later sailing. At other times, ferries typically run below capacity, with all passengers and vehicles accommodated with additional room available. The actual capacity at which an agency should consider increasing the number of ferries it operates on a given route depends on the acceptable level of service (LOS) for ferry operation.

The Alaska Department of Transportation and Public Facilities (DOT&PF) does not have standards or methods for determining LOS for ferries. Washington State Department of Transportation's (WSDOT) standards and methods for determining LOS for ferries could be applied to the Gravina Access Project because Washington's ferry network is used for commuter and recreational routes and its standards provide an accurate reflection of actual service to ferry users. These standards and methods for determining LOS were used in this memorandum.¹

WSDOT measures LOS by determining the percentage of sailings that are full; i.e., at or above maximum capacity. When sailings are full, it indicates that a portion of vehicles and passengers cannot board at their preferred sailing time (i.e., vehicles and passengers are left waiting at the terminal for the next ferry because the ferry they intended to ride is full).

The WSDOT LOS standards consider the percentage of full sailing by route to determine and appropriate strategy for improving LOS. Routes that carry a large number of commuters have peak times during which there are many passengers that do not have much flexibility in their travel times, whereas routes that carry a large number of recreational travelers accommodate these travelers over a longer period because of the flexibility of their travel times. An acceptable LOS for a commuter route has a lower percentage of full sailings as compared to a route that is primarily for recreational users.

Under the WSDOT standards, there are two levels for considering LOS improvements:

- At Level 1, 25 to 35 percent of the sailing are full, depending on the route and ridership (i.e., 25 percent for a commuter route and 35 percent for a route that has more recreational riders). At this level, WSDOT recommends that planning agencies consider targeted strategies to spread demand and improve customer service.

¹ Washington State Department of Transportation, Final Long-Range Plan, Customer Service: Level of Service Standards (2009)

- At Level 2, 50 to 85 percent of the sailings are full depending on the route and ridership (i.e., 50 percent for a commuter route and 85 percent for a route that has more recreational riders). At this level, WSDOT considers the assets are being used efficiently and planning agencies should consider additional investment (e.g., adding a ferry).

4. ALTERNATIVE G4V: THRESHOLD FOR NEW FERRY DEVELOPMENT

For Alternative G4v of the Gravina Access Project, Level 2 LOS would indicate the need for investment in a new ferry. In order to determine the percentage of full sailing that would bring LOS to Level 2 with the airport ferry in Ketchikan, we considered the range of Level 2 LOS in the WSDOT standards. WSDOT Level 2 LOS ranged from 50 percent full sailings for routes with very pronounced peak trends (i.e., heavy commuter routes) to 85 percent full sailings for routes with the greatest time flexibility (i.e., largely recreational traffic). Ketchikan International Airport passengers are the largest user group for the airport ferry. Because flights are spread throughout the day, the peak periods for the ferry are also spread throughout the day. A value of 65 percent full sailings operating on the summer schedule was used as the Level 2 LOS for the airport ferry in Ketchikan.

With both the Main and Secondary ferries operating on the summer schedule, on a week day, the minimum passenger and vehicle ridership at Level 2 LOS would be:

Ferry Ridership at Level 2 LOS

| | Passengers | Vehicles |
|------------------------|-------------------|-----------------|
| Main Ferry | 1,983 | 436 |
| Secondary Ferry | 806 | 151 |
| Total ridership | 2,789 | 587 |

Vehicle and pedestrian ferry volumes were forecast to 2030 as part of the traffic analysis for the No Action Alternative in the Gravina Access Project SEIS. Two population growth scenarios were used in the forecast: a base case with negligible population growth and an optimistic case that assumed 1 percent population growth into the future.

The traffic model results for the No Action Alternative indicate the following ridership levels for the existing ferry: :

Ferry Ridership in 2030

| | Passengers | Vehicles |
|--|-------------------|-----------------|
| Base Case | 934 | 224 |
| Optimistic Case (1 Percent Growth Rate) | 1,327 | 324 |

In the base case, if all riders were accommodated during one peak period, the number of full sailings would be 12: six of the Main Ferry and six of the Secondary Ferry. These full sailings would represent 26 percent of the total sailings for the day. This assumes that all the riders for that day are on the at-capacity sailings and other sailings are completely empty. In the optimistic growth case, if all riders were accommodated during one peak period, the number of full sailings would be 18: nine of the Main Ferry and nine of the Secondary Ferry. These full sailings would represent 39 percent of the total sailings for the day. Again, this assumes that all the riders for that day are on the at-capacity sailings and other sailings are completely empty. In reality, the ferry use would be spread throughout the day and a lower percentage of full sailings is expected.

The addition of and improvements to facilities that support the ferry system under Alternative G4v would increase passenger and vehicle use of the ferries; however, it is unlikely to boost ridership and substantially increase the percentage of ferries operating at full capacity.

By extrapolating from the 1 percent population growth curve (optimum case), reaching 65 percent full sailings (with all other sailings being empty) would not occur until 2105.

Appendix C
M&O COST MATRIX



| | | | |
|-----------------------|--------------------------|----------------------|---------------------|
| Inflation Rate: 3.77% | Design Life: 20 Years | Life-Cycle: 75 Years | RibbonCutting: 2016 |
| Discount Rate: 2.30% | Structure Life: 75 Years | Construction: 2014 | End of Life: 2091 |

KETCHIKAN GRAVINA ISLAND ACCESS

M&O Cost Support
July 2012

| ALIGNMENT CROSSING ALTERNATIVES SEGMENT LENGTHS | | | | | | | | | | | | | | | | |
|---|---|---------------------------|-----------------------|--------------------------|-------------------------|---|----------------------|-----------------------------|-------------------------|---------------------|------------------------|-----------------|------------|---------------------|------------------------------|-----------------------------|
| ALT No | ALIGNMENT ALTERNATIVE | TOTAL CONCEPT LENGTH (LF) | Airport Access Length | Boro Lands Access Length | Revilla Island Segments | | | | Gravina Island Segments | | | | | | | |
| | | | | | Revilla Road Segment | Tongass Narrows/East Channel Bridge Segment | Pennock Road Segment | West Channel Bridge Segment | Gravina Road Segment | Airport Access Road | Gravina Island Highway | Lewis Reef Road | Seley Road | Airport Return Loop | G2 Connection to Lewis Point | G3 Connection to Clump Cove |
| C3-4 | 550x200-foot high connection to Airport Terminal | 45,408 | 11,000 | 34,408 | 3,100 | 5,000 | na | na | 800 | 6,084 | 16,714 | 7,380 | 4,230 | 2,100 | na | na |
| F3-1 | 350x60 and 550x200-foot high connections via Pennock Island | 42,584 | 30,974 | 11,610 | 50 | 1,985 | 4,605 | 2,450 | na | 6,084 | 15,800 | 7,380 | 4,230 | na | na | na |
| G2 | Ferry connection from Peninsula Point with existing ferry | 38,389 | 21,675 | 16,714 | na | na | na | na | na | 6,084 | 16,714 | 7,380 | 4,230 | na | 3,981 | na |
| G3 | Ferry connection from Downtown with existing ferry | 35,734 | 10,180 | 25,554 | na | na | na | na | 2,770 | 6,084 | 13,944 | 7,380 | 4,230 | na | na | 1,344 |
| G4 | Ferry connection with existing ferry terminal | 34,408 | 0 | 34,408 | na | na | na | na | na | 6,084 | 16,714 | 7,380 | 4,230 | na | na | na |
| G4v | Ferry connection with existing ferry terminal | 34,408 | 0 | 34,408 | na | na | na | na | na | 6,084 | 16,714 | 7,380 | 4,230 | na | na | na |
| NB | No Action | 30,178 | 0 | 30,178 | na | na | na | na | na | 6,084 | 16,714 | 7,380 | na | na | na | na |

| (per 100LF @ 40' wide) GUARDRAIL COSTS (per 100LF) | | | | MODULAR EXPANSION JOINT COSTS (each) | | | | LIFE-CYCLE COST SUMMARY* | | | | | | | | | | |
|--|--|--|------------|--------------------------------------|------------|-------------|--------|--------------------------|--------------|---------------|--|--|--|--|--|--|--|--|
| 8% Engineering: \$ 756 | 8% Engineering: \$ 1,737 | 8% Engineering: \$ 51,529 | \$ 17,311 | Alt No | Paved Road | Gravel Road | Bridge | Ferry/Dock | Extras | TOTAL | | | | | | | | |
| Existing Roadway (@ \$6.50/SY): \$ 963 | Removal of Old Railing (@ \$10/LF): \$ 2,000 | Removal of Old Joint* (@ \$100/LF): \$ 5,100 | \$ 2,550 | C3-4 | | | | | | \$222,466,323 | | | | | | | | |
| Overlay Pavement (@ \$75/ton): \$ 3,800 | W-Beam Guardrail (@ \$45/LF): \$ 9,000 | Install New Joint* (@ \$300/inch/LF): \$ 321,300 | \$ 107,100 | F3-1 | | | | | | \$286,470,404 | | | | | | | | |
| Striping (@ \$1500/mile): \$ 28 | 10% Traffic Control: \$ 1,100 | 10% Traffic Control: \$ 32,640 | \$ 10,965 | G2 | | | | \$315,837,698 | \$15,635,038 | \$331,472,736 | | | | | | | | |
| 10% Traffic Control: \$ 479 | 10% Office, Survey, EroPolu: \$ 1,100 | 10% Office, Survey, EroPolu: \$ 32,640 | \$ 10,965 | G3 | | | | \$298,544,240 | \$15,635,038 | \$314,179,278 | | | | | | | | |
| 10% Office, Survey, EroPolu: \$ 479 | 30% Contingencies: \$ 3,960 | 30% Contingencies: \$ 117,504 | \$ 39,474 | G4 | | | | \$285,276,643 | \$15,635,038 | \$300,911,681 | | | | | | | | |
| 30% Contingencies: \$ 1,725 | 10% Mob and Demob: \$ 1,716 | 10% Mob and Demob: \$ 50,918 | \$ 17,105 | G4v | | | | \$165,965,137 | \$15,635,038 | \$181,600,175 | | | | | | | | |
| 10% Mob and Demob: \$ 747 | 15% Construction Admin: \$ 2,831 | 15% Construction Admin: \$ 84,015 | \$ 28,224 | No Action | | | | | | \$88,018,416 | | | | | | | | |
| 15% Construction Admin: \$ 1,233 | Total: \$ 23,444 | ular Expansion Joint Replacement Total: \$ 695,647 | | | | | | | | | | | | | | | | |
| Total: \$ 10,212 | | Gland Replacement Total: \$ 233,694 | | | | | | | | | | | | | | | | |

* assume 21" joints at bridge ends; remove old glands \$50/LF, new glands \$100/LF, remove old joints \$100"/LF, new joints \$300"/LF

* without revenue
Extras are the passenger waiting area, heavy freight dock and staging area, and ferry layup berth

| M&O UNIT COSTS | | | | | |
|---|---------------|---------------------|-------------|-------------|-------------------|
| CROSSING CONCEPT MAINTENANCE COSTS | CYCLE (Years) | PAVED ROAD | GRAVEL ROAD | BRIDGE | FERRY |
| | | COST/LF or LUMP SUM | | | |
| Annualized General Maintenance* ** ** ** ** | 1 | \$4.29 | \$4.29 | \$1.14 | \$5.71/5.70/3.42M |
| Periodic Maintenance Costs: | | | | | |
| Bridge inspections, above ground | 2 | | | \$40,000 | |
| Bridge inspections, underwater foundations | 5 | | | \$40,000 | |
| Rail replacement: 10% bridge 50% road | 5 | \$117 | \$117 | \$23 | |
| Planing and pavement overlay | 10 | \$102 | | \$102 | |
| Joint neoprene gland replacement | 10 | | | \$500,000 | |
| Joint assembly replacement | 25 | | | \$1,400,000 | |
| Signing and illumination replacement***** | 15 | \$5 | \$5 | \$5 | |
| Ferry Replacement | 40 | | | | \$8.0M |

* Annual Roadway Maintenance for Paved Road: \$5000/lane-mile = 2 lanes with 2 shoulders = 4 lanes = \$4/2-lane linear foot
 ** Annual Roadway Maintenance for Gravel Road: \$6500/lane-mile = 2 lanes with 2 shoulders = 4 lanes = \$5/2-lane linear foot
 *** Annual Bridge Maintenance costs are in addition to the roadway maintenance costs: \$1500/lane-mile = 2 lanes with 2 shoulders = 4 lanes = \$1/2-lane linear foot
 **** Annual Ferry Maintenance costs for Alternative G2 and G3 (\$5.71), and G4 (\$5.70M)
 ***** Signing and Illumination repair and/or replacement: \$25,000/mile/year = \$5/linear foot
 ***** No Action ferry maintenance is the 0.6 annual maintenance of the ferry (\$3,420,000) plus the roadway costs (6,084 + 16,714 + 7,380 = 30,178 * \$5/LF = \$150,890) \$3,570,890

| M&O COST SUMMARY | | | | | | | |
|------------------|--------------|-----------|---------------|-----------|---------------|-----------------------|----------------|
| ALT No | Paved Length | M&O Cost | Gravel Length | M&O Cost | Bridge Length | Bridge/Ferry M&O Cost | Total M&O Cost |
| C3-4 | 21,470 | \$92,091 | 34,408 | \$147,585 | 4,190 | \$4,761 | \$244,437 |
| F3-1 | 30,974 | \$132,856 | 11,610 | \$49,798 | 4,435 | \$5,040 | \$187,694 |
| G2 | 21,675 | \$92,970 | 16,714 | \$71,691 | -- | \$5,710,000 | \$5,874,661 |
| G3 | 10,180 | \$43,665 | 25,554 | \$109,608 | -- | \$5,710,000 | \$5,863,273 |
| G4 | 0 | \$0 | 34,408 | \$147,585 | -- | \$5,700,000 | \$5,847,585 |
| G4v | 0 | \$0 | 34,408 | \$147,585 | -- | \$3,420,000 | \$3,567,585 |
| No Action | 0 | \$0 | 30,178 | \$129,442 | -- | \$3,420,000 | \$3,549,442 |

Appendix D
CONSTRUCTION COST MATRIX



Gravina Island Access Engineer's Construction Cost Matrix

October 2011

| Category | C3-4 | | F3-1 | | G2 | | G3 | | G4 | | G4v | |
|---|-----------------|-----------------------|-----------------|-----------------------|-----------------|----------------------|-----------------|----------------------|-----------------|----------------------|-----------------|----------------------|
| | Length or Sq Ft | Cost | Length or Sq Ft | Cost | Length or Sq Ft | Cost | Length or Sq Ft | Cost | Length or Sq Ft | Cost | Length or Sq Ft | Cost |
| ROADWAY | | | | | | | | | | | | |
| MAINLINE ROADWAY CONSTRUCTION SUBTOTAL ³ | 9,888 | \$ 8,735,530 | 30,974 | \$ 15,255,074 | 21,675 | \$ 7,579,987 | 10,180 | \$ 2,389,634 | 0 | \$ - | 0 | \$ - |
| Mainline Pavement | | \$ 402,637 | | \$ 3,784,680 | | \$ 2,901,384 | | \$ 584,299 | | \$ - | | \$ - |
| Seley Road Widening ⁴ | 4,230 | \$ 3,156,926 | 4,230 | \$ 3,156,926 | 11,605 | \$ 3,156,926 | 4,230 | \$ 3,156,926 | 4,230 | \$ 3,156,926 | 4,230 | \$ 3,156,926 |
| Airport Access Road Paving ² | | \$ - | 4,300 | \$ 476,064 | 4,300 | \$ 476,064 | 4,300 | \$ 476,064 | | \$ - | | \$ - |
| Roadway Contingency (15% of Road Construction Subtotal) | | \$ 1,900,000 | | \$ 3,500,000 | | \$ 2,200,000 | | \$ 1,000,000 | | \$ 500,000 | | \$ 500,000 |
| ROADWAY CONSTRUCTION SUBTOTAL | | \$ 14,195,093 | | \$ 26,172,743 | | \$ 16,314,361 | | \$ 7,606,923 | | \$ 3,656,926 | | \$ 3,656,926 |
| STRUCTURES⁵ | | | | | | | | | | | | |
| Government Creek Bridge Widening (Sta 141+50 to Sta 145+00) | | | 4,200 | \$ 698,169 | | | | | | | | |
| Gravina Creek Bridge Widening (Sta 197+40 to Sta 198+20) | | | 960 | \$ 232,723 | | | | | | | | |
| West Channel Bridge | | | 126,639 | \$ 94,896,336 | | | | | | | | |
| East Channel Bridge | | | 101,731 | \$ 76,231,644 | | | | | | | | |
| Tongass Narrows Bridge | 214,738 | \$ 152,872,961 | | | | | | | | | | |
| Airport Creek Bridge | 3,060 | \$ 996,985 | 3,060 | \$ 996,985 | 3,400 | \$ 996,985 | 3,060 | \$ 996,985 | 3,060 | \$ 996,985 | 3,060 | \$ 996,985 |
| Dredging for West Channel | | | | \$ 13,097,530 | | | | | | | | |
| STRUCTURE CONSTRUCTION SUBTOTAL | | \$ 153,869,946 | | \$ 186,153,388 | | \$ 996,985 | | \$ 996,985 | | \$ 996,985 | | \$ 996,985 |
| MOBILIZATION & DEMOBILIZATION (10% of Subtotals) | | \$ 16,900,000 | | \$ 21,300,000 | | \$ 1,800,000 | | \$ 900,000 | | \$ 500,000 | | \$ 500,000 |
| ROADWAY CONSTRUCTION SUBTOTAL | | \$ 184,965,040 | | \$ 233,626,131 | | \$ 19,111,347 | | \$ 9,503,908 | | \$ 5,153,912 | | \$ 5,153,912 |
| FERRIES | | | | | | | | | | | | |
| Two New Ferries and Two New Docks | | | | | | \$ 34,945,030 | | \$ 35,264,722 | | \$ 33,527,330 | | |
| Passenger Waiting and Enhanced Baggage Handling Facility | | | | | | \$ 1,403,387 | | \$ 1,403,387 | | \$ 1,403,387 | | \$ 1,403,387 |
| Ferry Layup Berth | | | | | | \$ 5,987,786 | | \$ 5,987,786 | | \$ 5,987,786 | | \$ 5,987,786 |
| Heavy Freight Terminal and 3/4-acre Staging Area | | | | | | \$ 5,426,431 | | \$ 5,426,431 | | \$ 5,426,431 | | \$ 5,426,431 |
| FERRY CONSTRUCTION SUBTOTAL | | | | | | \$ 47,762,634 | | \$ 48,082,326 | | \$ 46,344,935 | | \$ 12,817,605 |
| SEGMENT CONSTRUCTION SUBTOTAL | | \$ 184,965,040 | | \$ 233,626,131 | | \$ 66,873,981 | | \$ 57,586,235 | | \$ 51,498,846 | | \$ 17,971,516 |
| CONSTRUCTION ADMINISTRATION (5% of Seg Const Subtotal) | | \$ 9,250,000 | | \$ 11,690,000 | | \$ 3,350,000 | | \$ 2,880,000 | | \$ 2,580,000 | | \$ 900,000 |
| TOTAL CONSTRUCTION AMOUNT | | \$ 194,215,040 | | \$ 245,316,131 | | \$ 70,223,981 | | \$ 60,466,235 | | \$ 54,078,846 | | \$ 18,871,516 |
| DESIGN (7% of Total Construction Amount) | | \$ 13,600,000 | | \$ 17,180,000 | | \$ 4,920,000 | | \$ 4,240,000 | | \$ 3,790,000 | | \$ 1,330,000 |
| UTILITIES | | \$ 1,000,000 | | \$ 100,000 | | \$ 1,000,000 | | \$ 1,000,000 | | \$ 1,000,000 | | \$ 1,000,000 |
| RIGHT-OF-WAY | | \$ 3,810,000 | | \$ 220,000 | | \$ 1,000,000 | | \$ 1,000,000 | | \$ 500,000 | | \$ 500,000 |
| PROJECT CONSTRUCTION and DEVELOPMENT SUBTOTAL | | \$ 212,625,040 | | \$ 262,816,131 | | \$ 77,143,981 | | \$ 66,706,235 | | \$ 59,368,846 | | \$ 21,701,516 |
| ICAP (5.0 % of Total) | | \$ 10,640,000 | | \$ 13,150,000 | | \$ 3,860,000 | | \$ 3,340,000 | | \$ 2,970,000 | | \$ 1,090,000 |
| GRAND TOTAL | | \$ 223,265,040 | | \$ 275,966,131 | | \$ 81,003,981 | | \$ 70,046,235 | | \$ 62,338,846 | | \$ 22,791,516 |

Notes:

- (1) Parking garage costs are not included in the above estimates. This cost is common to all alternatives at \$13.1 million.
- (2) The Airport Access Road was recently reconstructed under the runway extension project, to the intersection of the GIH (about Sta 138-). The costs herein are only for base and pavement for the existing 40-foot wide gravel road (Sta 17- to 60-).
- (3) Mainline Roadway Construction Subtotal includes all road construction costs (including Seley Road) for each alternative as described in the engineers estimate report from Revilla Island to the airport terminal, except for pavement (as requested by the Regional Director).
- (4) The Seley Road costs are to upgrade the existing logging road between the *Airport Creek* bridge and the north Airport reserve (and G2 intersection) to match the existing 36-foot wide gravel Lewis Reef Road.
- (5) All structure costs include 20 percent contingency.
- (6) All costs are 2011 dollars.
- (7) Historical bid tab data was used to updated the unit prices. Only information from projects with similar project location and quantities were used.
- (8) FHWA NHCCI Index was used to normalize historic bid tab data in the years between 2003 and 2010
- (9) In lieu of an NHCCI index for 2011 the negative trend from 2009-2010 was linearly projected to determine the 2011 index.
- (10) Industry trends suggest little change in structure costs from 2008 to 2011, as such, all structure costs remain unchanged from the 2008 estimate.

Appendix E
LIFE-CYCLE COST REPORT

BridgeLCC 2.0 Reports

Gravina Island Access -- C3-4 and F3-1 Alignments (w/ and w/o Revenues)

11/03/2011

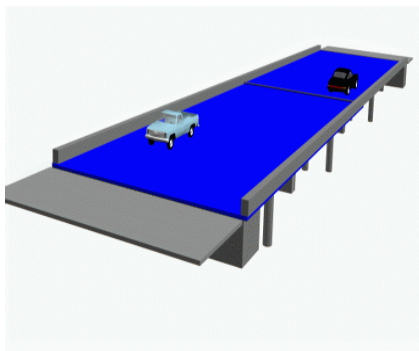

Building and Fire Research Laboratory
National Institute of Standards and Technology
Gaithersburg, MD

Analysis: Summary of Life-Cycle Costs

11/03/2011

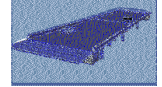

| | Name | Base Case | Alternative #1 | Alternative #2 | Alternative #3 |
|---------------------------|------------------------------|----------------------|-----------------------|-----------------------|-----------------------|
| | Total Life-Cycle Cost | \$222,466,323 | \$214,116,708 | \$286,470,404 | \$279,790,711 |
| By Cost Bearer: | Agency Costs | \$222,466,323 | \$214,116,708 | \$286,470,404 | \$279,790,711 |
| | User Costs | \$ 0 | \$ 0 | \$ 0 | \$ 0 |
| | Third-Party Costs | \$ 0 | \$ 0 | \$ 0 | \$ 0 |
| By Cost Timing: | Initial Construction Costs | \$203,853,508 | \$203,853,508 | \$251,972,561 | \$251,972,561 |
| | OM&R Costs | \$ 18,612,815 | \$ 10,263,200 | \$ 34,497,843 | \$ 27,818,150 |
| | Disposal Costs | \$ 0 | \$ 0 | \$ 0 | \$ 0 |
| By Cost Component: | Elemental Costs | \$222,466,323 | \$214,116,708 | \$286,470,404 | \$279,790,711 |
| | Non-elemental Costs | \$ 0 | \$ 0 | \$ 0 | \$ 0 |
| | New-Technology | \$ 0 | \$ 0 | \$ 0 | \$ 0 |



Data: Description

11/03/2011

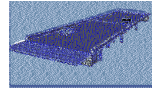

Name: Gravina Island Access -- C3-4 and F3-1 Alignments (w/ and w/o **Date:** 10/27/2011

Objective:

Life-cycle costs of the owner's costs, with and without consideration of their tolling income. It is assumed that the toll fares would be established to completely offset the annual maintenance and operations expenses for bridge(s) and approach roadways.

The life-cycle costs include all costs for the gravel roads serving the KGB developable lands.

Revenues collected are for the maintenance of the bridge(s) and paved approach roadways only; they do not reflect the expenses for the gravel roads.



Data: Project Parameters

11/03/2011

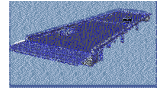

Study Period

| | |
|------------------|------|
| Base Year | 2011 |
| Length of period | 80 |
| Last Year | 2091 |

Currency

U.S. Dollars (\$)

Interest Rates

| | |
|---------------|-------|
| Inflation | 3.77% |
| Real Discount | 2.30% |

Elements

| | |
|----|----------------|
| #1 | Bridge |
| #2 | Paved Road |
| #3 | Gravel Road |
| #4 | Ferry |
| #5 | Dock |
| #6 | Non-elemental |
| #7 | New technology |



Data: Alternatives

11/03/2011

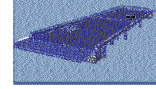

C3-4 (w/o Revenue)

| | | | |
|----------|---|-----------------------|------------|
| Lanes on | 2 | Area of deck (ft) | 214,738.00 |
| | 0 | Length of bridge (ft) | 4,190.00 |

Alignment C3-4. Provide paved access along the KGB's Bench (ByPass) Road between North Tongass Avenue on Revilla Island and the KTN passenger terminal on Gravina Island with a single balanced cantilever cast-in-place concrete box girder bridge over Tongass Narrows that will allow for a 200 x 550-foot navigational opening.

Also included are gravel roads serving the KGB developable lands on Gravina Island.

An annual revenue stream is NOT included in these LCC calculations.

C3-4 (w/ Revenue)

| | | | |
|----------|---|-----------------------|------------|
| Lanes on | 2 | Area of deck (ft) | 214,738.00 |
| | 0 | Length of bridge (ft) | 4,190.00 |

Alignment C3-4. Provide paved access along the KGB's Bench (ByPass) Road between North Tongass Avenue on Revilla Island and the KTN passenger terminal on Gravina Island with a single balanced cantilever cast-in-place concrete box girder bridge over Tongass Narrows that will allow for a 200 x 550-foot navigational opening.

Also included are gravel roads serving the KGB developable lands on Gravina Island.

An anticipated annual revenue stream offsetting the cost of bridge and roadway approaches (\$250,000) is included in these LCC calculations.

F3-1 (w/o Revenue)

| | | | |
|----------|---|-----------------------|------------|
| Lanes on | 2 | Area of deck (ft) | 228,319.00 |
| | 0 | Length of bridge (ft) | 4,455.00 |

Alignment F3-1. Provide paved access between South Tongass Avenue near the USCG Station on Revilla Island, across Pennock Island, and up Gravina Island to the KTN passenger terminal with two balanced cantilever cast-in-place concrete box girder bridge over Tongass Narrows. The East Channel will allow for a 60 x 350-foot navigational opening, and the West Channel will provide for a 200 x 550-foot navigational opening.

Also included are gravel roads serving the KGB developable lands on Gravina Island.

An annual revenue stream is NOT included in these LCC calculations.



Data: Alternatives

11/03/2011

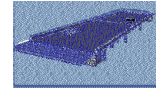

F3-1 (w/ Revenue)

| | | | |
|----------|---|-----------------------|------------|
| Lanes on | 2 | Area of deck (ft) | 228,319.00 |
| | 0 | Length of bridge (ft) | 4,455.00 |

Alignment F3-1. Provide paved access between South Tongass Avenue near the USCG Station on Revilla Island, across Pennock Island, and up Gravina Island to the KTN passenger terminal with two balanced cantilever cast-in-place concrete box girder bridge over Tongass Narrows. The East Channel will allow for a 60 x 350-foot navigational opening, and the West Channel will provide for a 200 x 550-foot navigational opening.

Also included are gravel roads serving the KGB developable lands on Gravina Island.

An anticipated annual revenue stream offsetting the cost of bridge and roadway approaches (\$200,000) is included in these LCC calculations.



Data: Individual Costs

11/03/2011

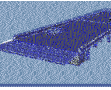

| Item | Event | Start Year | End Year | Frequency | Qty | Unit of Measure | Unit Cost | Total | Remarks |
|----------------------------|------------|------------|----------|-----------|-----------|-----------------|---------------|---------------|---------|
| Base Case | | | | | | | | | |
| Agency | | | | | | | | | |
| Initial Construction | | | | | | | | | |
| Construction cost | <no event> | 5 | 5 | 1.0000 | 1.000 | LS | \$223,265,040 | \$223,265,040 | . |
| Disposal | | | | | | | | | |
| Disposal cost | <no event> | 80 | 80 | 1.0000 | 1.000 | LS | \$ 0 | \$ 0 | . |
| O, M, and R | | | | | | | | | |
| M&O Bridge | <no event> | 5 | 80 | 1.0000 | 4190.000 | Length of | \$ 1 | \$ 4,819 | |
| M&O Paved Road | <no event> | 5 | 80 | 1.0000 | 9842.000 | LS | \$ 4 | \$ 42,321 | |
| M&O Gravel Road | <no event> | 5 | 80 | 1.0000 | 34408.000 | LS | \$ 4 | \$ 147,954 | |
| Inspection Above Gound | <no event> | 7 | 80 | 2.0000 | 1.000 | LS | \$ 40,000 | \$ 40,000 | |
| Inspection Underwater | <no event> | 10 | 80 | 5.0000 | 1.000 | LS | \$ 40,000 | \$ 40,000 | |
| Guardrail Bridge | <no event> | 10 | 80 | 5.0000 | 4190.000 | Length of | \$ 23 | \$ 96,370 | |
| Guardrail Paved Road | <no event> | 10 | 80 | 5.0000 | 2826.000 | LS | \$ 117 | \$ 330,642 | |
| Guardrail Gravel Road | <no event> | 10 | 80 | 5.0000 | 3441.000 | LS | \$ 117 | \$ 402,597 | |
| Replace Pavement Bridge | <no event> | 15 | 80 | 10.0000 | 4190.000 | Length of | \$ 102 | \$ 427,380 | |
| Replace Pavement Paved | <no event> | 15 | 80 | 10.0000 | 5652.000 | LS | \$ 102 | \$ 576,504 | |
| Anode Replacement | <no event> | 15 | 80 | 10.0000 | 1.000 | LS | \$ 100,000 | \$ 100,000 | |
| Joint Gland Replacement | <no event> | 15 | 80 | 10.0000 | 1.000 | LS | \$ 500,000 | \$ 500,000 | |
| Signs/Illumination Bridge | <no event> | 20 | 80 | 15.0000 | 4190.000 | Length of | \$ 5 | \$ 20,950 | |
| Signs/Illumination Paved | <no event> | 20 | 80 | 15.0000 | 2826.000 | LS | \$ 5 | \$ 14,130 | |
| Signs/Illumination Gravel | <no event> | 20 | 80 | 15.0000 | 6881.000 | LS | \$ 5 | \$ 34,405 | |
| Joint Assembly Replacement | <no event> | 30 | 80 | 25.0000 | 1.000 | LS | \$ 1,400,000 | \$ 1,400,000 | |

Alternative #2

Agency

Initial Construction



Data: Individual Costs

11/03/2011

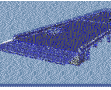

| Item | Event | Start Year | End Year | Frequency | Qty | Unit of Measure | Unit Cost | Total | Remarks |
|----------------------------|------------|------------|----------|-----------|-----------|-----------------|---------------|---------------|---------|
| Construction cost | <no event> | 5 | 5 | 1.0000 | 1.000 | LS | \$275,966,131 | \$275,966,131 | . |
| O, M, and R | | | | | | | | | |
| M&O Bridge | <no event> | 5 | 80 | 1.0000 | 4455.000 | Length of | \$ 1 | \$ 5,123 | |
| M&O Paved Road | <no event> | 5 | 80 | 1.0000 | 30973.000 | LS | \$ 4 | \$ 133,184 | |
| M&O Gravel Road | <no event> | 5 | 80 | 1.0000 | 11610.000 | LS | \$ 4 | \$ 49,923 | |
| Inspection Above Ground | <no event> | 7 | 80 | 2.0000 | 2.000 | LS | \$ 40,000 | \$ 80,000 | |
| Inspection Underwater | <no event> | 10 | 80 | 5.0000 | 2.000 | LS | \$ 40,000 | \$ 80,000 | |
| Guardrail Bridge | <no event> | 10 | 80 | 5.0000 | 4455.000 | Length of | \$ 23 | \$ 102,465 | |
| Guardrail Paved Road | <no event> | 10 | 80 | 5.0000 | 13259.000 | LS | \$ 117 | \$ 1,551,303 | |
| Guardrail Gravel Road | <no event> | 10 | 80 | 5.0000 | 1161.000 | LS | \$ 117 | \$ 135,837 | |
| Replace Pavement Bridge | <no event> | 15 | 80 | 10.0000 | 4455.000 | Length of | \$ 102 | \$ 454,410 | |
| Replace Pavement Road | <no event> | 15 | 80 | 10.0000 | 26518.000 | LS | \$ 102 | \$ 2,704,836 | |
| Anode Replacement | <no event> | 15 | 80 | 10.0000 | 2.000 | LS | \$ 100,000 | \$ 200,000 | |
| Joint Gland Replacement | <no event> | 15 | 80 | 10.0000 | 2.000 | LS | \$ 500,000 | \$ 1,000,000 | |
| Signs/Illumination Bridge | <no event> | 20 | 80 | 15.0000 | 4455.000 | Length of | \$ 5 | \$ 22,275 | |
| Signs/Illumination Paved | <no event> | 20 | 80 | 15.0000 | 13259.000 | LS | \$ 5 | \$ 66,295 | |
| Signs/Illumination Gravel | <no event> | 20 | 80 | 15.0000 | 2322.000 | LS | \$ 5 | \$ 11,610 | |
| Joint Assembly Replacement | <no event> | 30 | 80 | 25.0000 | 2.000 | LS | \$ 1,400,000 | \$ 2,800,000 | |
| Disposal | | | | | | | | | |
| Disposal cost | <no event> | 80 | 80 | 1.0000 | 1.000 | LS | \$ 0 | \$ 0 | . |

Alternative #3

Agency

Initial Construction

| | | | | | | | | | |
|-------------------|------------|---|---|--------|-------|----|---------------|---------------|---|
| Construction cost | <no event> | 5 | 5 | 1.0000 | 1.000 | LS | \$275,966,131 | \$275,966,131 | . |
|-------------------|------------|---|---|--------|-------|----|---------------|---------------|---|

O, M, and R

| | | | | | | | | | |
|------------|------------|---|----|--------|----------|-----------|------|----------|--|
| M&O Bridge | <no event> | 5 | 80 | 1.0000 | 4455.000 | Length of | \$ 1 | \$ 5,123 | |
|------------|------------|---|----|--------|----------|-----------|------|----------|--|



Data: Individual Costs

11/03/2011

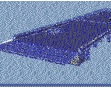

| Item | Event | Start Year | End Year | Frequency | Qty | Unit of Measure | Unit Cost | Total | Remarks |
|----------------------------|------------|------------|----------|-----------|-----------|-----------------|--------------|--------------|---------|
| M&O Paved Road | <no event> | 5 | 80 | 1.0000 | 30973.000 | LS | \$ 4 | \$ 133,184 | |
| M&O Gravel Road | <no event> | 5 | 80 | 1.0000 | 11610.000 | LS | \$ 4 | \$ 49,923 | |
| Inspection Above Ground | <no event> | 7 | 80 | 2.0000 | 2.000 | LS | \$ 40,000 | \$ 80,000 | |
| Inspection Underwater | <no event> | 10 | 80 | 5.0000 | 2.000 | LS | \$ 40,000 | \$ 80,000 | |
| Guardrail Bridge | <no event> | 10 | 80 | 5.0000 | 4455.000 | Length of | \$ 23 | \$ 102,465 | |
| Guardrail Paved Road | <no event> | 10 | 80 | 5.0000 | 13259.000 | LS | \$ 117 | \$ 1,551,303 | |
| Guardrail Gravel Road | <no event> | 10 | 80 | 5.0000 | 1161.000 | LS | \$ 117 | \$ 135,837 | |
| Replace Pavement Bridge | <no event> | 15 | 80 | 10.0000 | 4455.000 | Length of | \$ 102 | \$ 454,410 | |
| Replace Pavement Road | <no event> | 15 | 80 | 10.0000 | 26518.000 | LS | \$ 102 | \$ 2,704,836 | |
| Anode Replacement | <no event> | 15 | 80 | 10.0000 | 2.000 | LS | \$ 100,000 | \$ 200,000 | |
| Joint Gland Replacement | <no event> | 15 | 80 | 10.0000 | 2.000 | LS | \$ 500,000 | \$ 1,000,000 | |
| Signs/Illumination Bridge | <no event> | 20 | 80 | 15.0000 | 4455.000 | Length of | \$ 5 | \$ 22,275 | |
| Signs/Illumination Paved | <no event> | 20 | 80 | 15.0000 | 13259.000 | LS | \$ 5 | \$ 66,295 | |
| Signs/Illumination Gravel | <no event> | 20 | 80 | 15.0000 | 2322.000 | LS | \$ 5 | \$ 11,610 | |
| Joint Assembly Replacement | <no event> | 30 | 80 | 25.0000 | 2.000 | LS | \$ 1,400,000 | \$ 2,800,000 | |
| Toll Revenue | <no event> | 5 | 80 | 1.0000 | 1.000 | LS | \$ -200,000 | \$ -200,000 | |
| Disposal | | | | | | | | | |
| Disposal cost | <no event> | 80 | 80 | 1.0000 | 1.000 | LS | \$ 0 | \$ 0 | |

Alternative #1

Agency

Initial Construction

| | | | | | | | | | |
|-------------------|------------|---|---|--------|-------|----|---------------|---------------|--|
| Construction cost | <no event> | 5 | 5 | 1.0000 | 1.000 | LS | \$223,265,040 | \$223,265,040 | |
|-------------------|------------|---|---|--------|-------|----|---------------|---------------|--|

O, M, and R

| | | | | | | | | | |
|-----------------|------------|---|----|--------|-----------|-----------|------|------------|--|
| M&O Bridge | <no event> | 5 | 80 | 1.0000 | 4190.000 | Length of | \$ 1 | \$ 4,819 | |
| M&O Paved Road | <no event> | 5 | 80 | 1.0000 | 9842.000 | LS | \$ 4 | \$ 42,321 | |
| M&O Gravel Road | <no event> | 5 | 80 | 1.0000 | 34408.000 | LS | \$ 4 | \$ 147,954 | |



Data: Individual Costs

11/03/2011

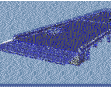

| Item | Event | Start Year | End Year | Frequency | Qty | Unit of Measure | Unit Cost | Total | Remarks |
|----------------------------|------------|------------|----------|-----------|----------|-----------------|--------------|--------------|---------|
| Inspection Above Gound | <no event> | 7 | 80 | 2.0000 | 1.000 | LS | \$ 40,000 | \$ 40,000 | |
| Inspection Underwater | <no event> | 10 | 80 | 5.0000 | 1.000 | LS | \$ 40,000 | \$ 40,000 | |
| Guardrail Bridge | <no event> | 10 | 80 | 5.0000 | 4190.000 | Length of | \$ 23 | \$ 96,370 | |
| Guardrail Paved Road | <no event> | 10 | 80 | 5.0000 | 2826.000 | LS | \$ 117 | \$ 330,642 | |
| Guardrail Gravel Road | <no event> | 10 | 80 | 5.0000 | 3441.000 | LS | \$ 117 | \$ 402,597 | |
| Replace Pavement Bridge | <no event> | 15 | 80 | 10.0000 | 4190.000 | Length of | \$ 102 | \$ 427,380 | |
| Replace Pavement Paved | <no event> | 15 | 80 | 10.0000 | 5652.000 | LS | \$ 102 | \$ 576,504 | |
| Anode Replacement | <no event> | 15 | 80 | 10.0000 | 1.000 | LS | \$ 100,000 | \$ 100,000 | |
| Joint Gland Replacement | <no event> | 15 | 80 | 10.0000 | 1.000 | LS | \$ 500,000 | \$ 500,000 | |
| Signs/Illumination Bridge | <no event> | 20 | 80 | 15.0000 | 4190.000 | Length of | \$ 5 | \$ 20,950 | |
| Signs/Illumination Paved | <no event> | 20 | 80 | 15.0000 | 2826.000 | LS | \$ 5 | \$ 14,130 | |
| Signs/Illumination Gravel | <no event> | 20 | 80 | 15.0000 | 6881.000 | LS | \$ 5 | \$ 34,405 | |
| Joint Assembly Replacement | <no event> | 30 | 80 | 25.0000 | 1.000 | LS | \$ 1,400,000 | \$ 1,400,000 | |
| Toll Revenue | <no event> | 5 | 80 | 1.0000 | 1.000 | LS | \$ -250,000 | \$ -250,000 | |
| Disposal | | | | | | | | | |
| Disposal cost | <no event> | 80 | 80 | 1.0000 | 1.000 | LS | \$ 0 | \$ 0 | |



BridgeLCC 2.0 Reports

Ketchikan Gravina Island Access -- G Alignments (w/o Revenue)

07/06/2012

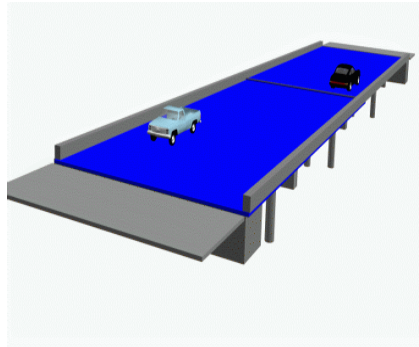

Building and Fire Research Laboratory
National Institute of Standards and Technology
Gaithersburg, MD

Analysis: Summary of Life-Cycle Costs

07/06/2012

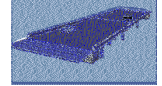

| | Name | Base Case | Alternative #1 | Alternative #2 | Alternative #3 | Alternative #4 | Alternative #5 |
|---------------------------|------------------------------|----------------------|-----------------------|-----------------------|-----------------------|-----------------------|-----------------------|
| | Total Life-Cycle Cost | \$315,837,698 | \$298,544,240 | \$285,276,643 | \$ 15,635,038 | \$165,965,137 | \$168,355,201 |
| By Cost Bearer: | Agency Costs | \$315,837,698 | \$298,544,240 | \$285,276,643 | \$ 15,635,038 | \$165,965,137 | \$168,355,201 |
| | User Costs | \$ 0 | \$ 0 | \$ 0 | \$ 0 | \$ 0 | \$ 0 |
| | Third-Party Costs | \$ 0 | \$ 0 | \$ 0 | \$ 0 | \$ 0 | \$ 0 |
| By Cost Timing: | Initial Construction Costs | \$ 73,961,179 | \$ 63,956,143 | \$ 56,918,864 | \$ 11,703,192 | \$ 20,809,933 | \$ 20,728,308 |
| | OM&R Costs | \$241,876,518 | \$234,588,098 | \$228,357,779 | \$ 3,931,846 | \$145,155,204 | \$147,626,894 |
| | Disposal Costs | \$ 0 | \$ 0 | \$ 0 | \$ 0 | \$ 0 | \$ 0 |
| By Cost Component: | Elemental Costs | \$315,837,698 | \$298,544,240 | \$285,276,643 | \$ 15,635,038 | \$165,965,137 | \$168,355,201 |
| | Non-elemental Costs | \$ 0 | \$ 0 | \$ 0 | \$ 0 | \$ 0 | \$ 0 |
| | New-Technology | \$ 0 | \$ 0 | \$ 0 | \$ 0 | \$ 0 | \$ 0 |



Data: Description

07/06/2012

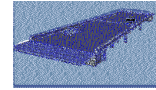

Name: Ketchikan Gravina Island Access -- G Alignments (w/o

Date: 07/06/2012

Objective:

Life-cycle costs of the owner's costs, without consideration of any income revenue. The average annual income revenue stream from ferry fares is NOT included in these LCC calculations for any G alternative.

Each of the G alternatives (Base Case and Alternatives #1 and #2) do not include the new amenities -- passenger waiting area, heavy freight dock and staging area, and ferry layup berth. The life-cycle costs of the new passenger waiting area, heavy freight dock and staging area, and ferry layup berth have been computed separately (Alternative #3). The total life-cycle costs would be the addition of the G alternatives and the amenities:

G2: \$331,472,736

G3: \$314,179,278

G4: \$300,911,681

A modified G4 alternative (G4v) was analyzed, both without a new ferry during the 75 year analysis, and with one ferry added in 2050; Alternatives #4 and #5, respectively. Alternative #4 (without ferry) is used in the cost report. With the amenities, the total life-cycle cost is:

G4v: \$181,600,175



Data: Project Parameters

07/06/2012

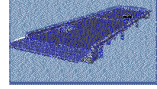

Study Period

| | |
|------------------|------|
| Base Year | 2011 |
| Length of period | 80 |
| Last Year | 2091 |

Currency

U.S. Dollars (\$)

Interest Rates

| | |
|---------------|-------|
| Inflation | 3.77% |
| Real Discount | 2.30% |

Elements

| | |
|----|----------------|
| #1 | Ferry |
| #2 | Dock |
| #3 | Paved Road |
| #4 | Gravel Road |
| #5 | |
| #6 | Non-elemental |
| #7 | New technology |



Data: Alternatives

07/06/2012

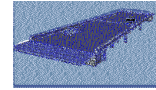

G2 (Peninsula Point)

| | | | |
|-------------------|---|-----------------------|------|
| Number of Ferries | 4 | Area of Deck (ft) | 0.00 |
| Number of Docks | 4 | Length of Bridge (ft) | 0.00 |

Alignment G2. In addition to the existing two (2) ferries and ferry terminals, provide two (2) new ferries and ferry terminals at Peninsula Point on Revilla Island and Lewis Point on Gravina Island. Included is a new paved road from Lewis Point up the hill to the Seley Road, and then an upgraded and paved Seley Road, and a paved Lewis Reef and Airport Access Roads to the KTN passenger terminal. Also included is the gravel Gravina Island Highway serving the KGB developable lands on Gravina Island.

G3 (Bar Point)

| | | | |
|-------------------|---|-----------------------|------|
| Number of Ferries | 4 | Area of Deck (ft) | 0.00 |
| Number of Docks | 4 | Length of Bridge (ft) | 0.00 |

Alignment G3. In addition to the existing two (2) ferries and ferry terminals, provide two (2) new ferries and ferry terminals at Bar Point on Jefferson Street near downtown Ketchikan on Revilla Island and near Clump Cove on Gravina Island. Included is a new paved road from Clump Cove up the hill to the Gravina Island Highway, and then across and down the Airport Access Roads to the KTN passenger terminal. Also included are the gravel Gravina Island Highway, Lewis Reef Road and Seley Road serving the KGB developable lands on Gravina Island.

G4 (Charcoal Point)

| | | | |
|-------------------|---|-----------------------|------|
| Number of Ferries | 4 | Area of Deck (ft) | 0.00 |
| Number of Docks | 4 | Length of Bridge (ft) | 0.00 |

Alignment G4. In addition to the existing two (2) ferries and ferry terminals, provide two (2) new ferries and ferry terminals adjacent to the existing terminals on Revilla and Gravina island at the crossing of Tongass Narrows to the KTN passenger terminal. Also included are the gravel Gravina Island Highway, Lewis Reef Road and Seley Road serving the KGB developable lands on Gravina Island.

Waiting Area, Freight Dock & Ferry Layup Berth

| | | | |
|-------------------|---|-----------------------|------|
| Number of Ferries | 0 | Area of Deck (ft) | 0.00 |
| Number of Docks | 2 | Length of Bridge (ft) | 0.00 |

This work includes construction of a passenger waiting terminal and baggage handling facility (including shuttle vans, etc) at Charcoal Point.

Included in the work is a new heavy freight dock and 2.5-acre staging area on Gravina Island for oversize and overweight loads that cannot be accommodated on the current shuttle ferries, at a location just south



Data: Alternatives

07/06/2012

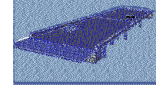

of the existing ferry terminal. This dock will also be capable of laying over AMHS-class ferries.

Additionally, the replacement of the currently closed I-90 floating dock with a new floating dock that will allow for tying off the airport shuttle ferries. This berth will be located between the Gravina Island ferry dock and the heavy freight dock.

G4v (Charcoal Point) w/o new Ferry

| | | | |
|-------------------|---|-----------------------|------|
| Number of Ferries | 2 | Area of Deck (ft) | 0.00 |
| Number of Docks | 2 | Length of Bridge (ft) | 0.00 |

Alignment G4v. Continuation of operation of the existing two (2) ferries and ferry terminals. Two (2) new ferries and ferry terminals adjacent to the existing terminals on Revilla and Gravina island at the crossing of Tongass Narrows to the KTN passenger terminal will be added at some future date WHEN TRAFFIC WARRANTS a system expansion -- beyond the term of this analysis. Also included are the gravel Gravina Island Highway, Lewis Reef Road and Seley Road serving the KGB developable lands on Gravina Island.

G4v (Charcoal Point) w/ new Ferry

| | | | |
|-------------------|---|-----------------------|------|
| Number of Ferries | 3 | Area of Deck (ft) | 0.00 |
| Number of Docks | 4 | Length of Bridge (ft) | 0.00 |

Alignment G4v. Continuation of operation of the existing two (2) ferries and ferry terminals. Two (2) new ferries and ferry terminals adjacent to the existing terminals on Revilla and Gravina islands at the crossing of Tongass Narrows to the KTN passenger terminal will be added at some future date when traffic warrants a system expansion -- one (1) new ferry and two (2) ferry terminals are assumed to be ADDED AT THE MID-LIFE (2050), for a total of three (3) ferries operating together between four (4) terminals. Also included are the gravel Gravina Island Highway, Lewis Reef Road and Seley Road serving the KGB developable lands on Gravina Island.



Data: Individual Costs

07/06/2012

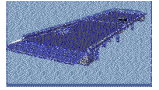

| Item | Event | Start Year | End Year | Frequency | Qty | Unit of Measure | Unit Cost | Total | Remarks |
|-----------------------------|------------|------------|----------|-----------|-----------|-----------------|---------------|---------------|---------|
| Base Case | | | | | | | | | |
| Agency | | | | | | | | | |
| Initial Construction | | | | | | | | | |
| Construction cost | <no event> | 5 | 5 | 1.0000 | 1.000 | LS | \$ 81,003,981 | \$ 81,003,981 | . |
| Disposal | | | | | | | | | |
| Disposal cost | <no event> | 80 | 80 | 1.0000 | 1.000 | LS | \$ 0 | \$ 0 | . |
| O, M, and R | | | | | | | | | |
| M&O Ferry and Dock | <no event> | 5 | 80 | 1.0000 | 1.000 | LS | \$ 5,800,000 | \$ 5,800,000 | |
| M&O Paved Road | <no event> | 5 | 80 | 1.0000 | 21675.000 | LS | \$ 4 | \$ 93,203 | |
| M&O Gravel Road | <no event> | 5 | 80 | 1.0000 | 16714.000 | LS | \$ 4 | \$ 71,870 | |
| Inspection Above Ground | <no event> | 7 | 80 | 2.0000 | 4.000 | LS | \$ 40,000 | \$ 160,000 | |
| Inspection Underwater | <no event> | 10 | 80 | 5.0000 | 4.000 | LS | \$ 25,000 | \$ 100,000 | |
| Guardrail Paved Road | <no event> | 10 | 80 | 5.0000 | 10838.000 | LS | \$ 117 | \$ 1,268,046 | |
| Guardrail Gravel Road | <no event> | 10 | 80 | 5.0000 | 1671.000 | LS | \$ 117 | \$ 195,507 | |
| Fendering System Repairs | <no event> | 10 | 80 | 5.0000 | 4.000 | LS | \$ 50,000 | \$ 200,000 | |
| Pavement Replacement Road | <no event> | 15 | 80 | 10.0000 | 21675.000 | LS | \$ 102 | \$ 2,210,850 | |
| Anode Replacement | <no event> | 15 | 80 | 10.0000 | 4.000 | LS | \$ 20,000 | \$ 80,000 | |
| Signs/Illumination Paved | <no event> | 20 | 80 | 15.0000 | 10838.000 | LS | \$ 5 | \$ 54,190 | |
| Signs/Illumination Gravel | <no event> | 20 | 80 | 15.0000 | 3343.000 | LS | \$ 5 | \$ 16,715 | |
| Recoat Transfer Span | <no event> | 20 | 80 | 15.0000 | 4.000 | LS | \$ 150,000 | \$ 600,000 | |
| Bridge Support-Float Recoat | <no event> | 20 | 80 | 15.0000 | 4.000 | LS | \$ 75,000 | \$ 300,000 | |
| Mooring Structure | <no event> | 40 | 80 | 35.0000 | 4.000 | LS | \$ 1,500,000 | \$ 6,000,000 | |
| Ferry Replacement | <no event> | 40 | 80 | 35.0000 | 3.000 | LS | \$ 8,000,000 | \$ 24,000,000 | |
| Transfer Bridge Replacement | <no event> | 15 | 80 | 75.0000 | 2.000 | LS | \$ 2,000,000 | \$ 4,000,000 | |

Alternative #5

Agency



Data: Individual Costs

07/06/2012

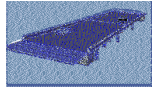

| Item | Event | Start Year | End Year | Frequency | Qty | Unit of Measure | Unit Cost | Total | Remarks |
|-----------------------------|------------|------------|----------|-----------|-----------|-----------------|---------------|---------------|------------------|
| Initial Construction | | | | | | | | | |
| Initial Construction Costs | <no event> | 5 | 5 | 1.0000 | 1.000 | LS | \$ 9,027,000 | \$ 9,027,000 | |
| Two More Docks Construction | <no event> | 40 | 80 | 75.0000 | 1.000 | LS | \$ 18,700,000 | \$ 18,700,000 | New Docks |
| One More Ferry Construction | <no event> | 40 | 80 | 35.0000 | 1.000 | LS | \$ 8,000,000 | \$ 8,000,000 | New Ferry |
| O, M, and R | | | | | | | | | |
| M&O Ferry and Dock | <no event> | 5 | 80 | 1.0000 | 1.000 | LS | \$ 3,600,000 | \$ 3,600,000 | |
| M&O Gravel Road | <no event> | 5 | 80 | 1.0000 | 34408.000 | LS | \$ 4 | \$ 147,954 | |
| Inspection Above Ground | <no event> | 7 | 80 | 2.0000 | 3.000 | LS | \$ 40,000 | \$ 120,000 | Quantity assumes |
| Inspection Underwater | <no event> | 10 | 80 | 5.0000 | 3.000 | LS | \$ 25,000 | \$ 75,000 | Quantity assumes |
| Guardrail Gravel Road | <no event> | 10 | 80 | 5.0000 | 3441.000 | LS | \$ 117 | \$ 402,597 | |
| Fendering System Repairs | <no event> | 10 | 80 | 5.0000 | 3.000 | LS | \$ 50,000 | \$ 150,000 | Quantity assumes |
| Anode Replacement | <no event> | 15 | 80 | 10.0000 | 3.000 | LS | \$ 20,000 | \$ 60,000 | Quantity assumes |
| Signs/Illumination Gravel | <no event> | 20 | 80 | 15.0000 | 6882.000 | LS | \$ 5 | \$ 34,410 | |
| Recoat Transfer Span | <no event> | 20 | 80 | 15.0000 | 3.000 | LS | \$ 150,000 | \$ 450,000 | Quantity assumes |
| Bridge Support-Float Recoat | <no event> | 20 | 80 | 15.0000 | 3.000 | LS | \$ 75,000 | \$ 225,000 | Quantity assumes |
| Mooring Structure | <no event> | 40 | 80 | 35.0000 | 3.000 | LS | \$ 1,500,000 | \$ 4,500,000 | Quantity assumes |
| Ferry Replacement | <no event> | 40 | 80 | 35.0000 | 2.000 | LS | \$ 8,000,000 | \$ 16,000,000 | |
| Transfer Bridge Replacement | <no event> | 15 | 80 | 75.0000 | 2.000 | LS | \$ 2,000,000 | \$ 4,000,000 | |
| Disposal | | | | | | | | | |
| Disposal Cost | <no event> | 1 | 1 | 1.0000 | 1.000 | LS | \$ 0 | \$ 0 | |

Alternative #4

Agency

Initial Construction

| | | | | | | | | | |
|----------------------------|------------|---|---|--------|-------|----|---------------|---------------|--|
| Initial Construction Costs | <no event> | 5 | 5 | 1.0000 | 1.000 | LS | \$ 22,791,516 | \$ 22,791,516 | |
|----------------------------|------------|---|---|--------|-------|----|---------------|---------------|--|

O, M, and R

| | | | | | | | | | |
|--------------------|------------|---|----|--------|-------|----|--------------|--------------|--|
| M&O Ferry and Dock | <no event> | 5 | 80 | 1.0000 | 1.000 | LS | \$ 3,600,000 | \$ 3,600,000 | |
|--------------------|------------|---|----|--------|-------|----|--------------|--------------|--|



Data: Individual Costs

07/06/2012

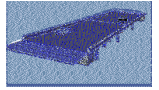

| Item | Event | Start Year | End Year | Frequency | Qtty | Unit of Measure | Unit Cost | Total | Remarks |
|-----------------------------|------------|------------|----------|-----------|-----------|-----------------|--------------|---------------|---------|
| M&O Gravel Road | <no event> | 5 | 80 | 1.0000 | 34408.000 | LS | \$ 4 | \$ 147,954 | |
| Inspection Above Ground | <no event> | 7 | 80 | 2.0000 | 2.000 | LS | \$ 40,000 | \$ 80,000 | |
| Inspection Underwater | <no event> | 10 | 80 | 5.0000 | 2.000 | LS | \$ 25,000 | \$ 50,000 | |
| Guardrail Gravel Road | <no event> | 10 | 80 | 5.0000 | 3441.000 | LS | \$ 117 | \$ 402,597 | |
| Fendering System Repairs | <no event> | 10 | 80 | 5.0000 | 2.000 | LS | \$ 50,000 | \$ 100,000 | |
| Anode Replacement | <no event> | 15 | 80 | 10.0000 | 2.000 | LS | \$ 20,000 | \$ 40,000 | |
| Signs/Illumination Gravel | <no event> | 20 | 80 | 15.0000 | 6882.000 | LS | \$ 5 | \$ 34,410 | |
| Recoat Transfer Span | <no event> | 20 | 80 | 15.0000 | 2.000 | LS | \$ 150,000 | \$ 300,000 | |
| Bridge Support-Float Recoat | <no event> | 20 | 80 | 15.0000 | 2.000 | LS | \$ 75,000 | \$ 150,000 | |
| Mooring Structure | <no event> | 40 | 80 | 35.0000 | 2.000 | LS | \$ 1,500,000 | \$ 3,000,000 | |
| Ferry Replacement | <no event> | 40 | 80 | 35.0000 | 2.000 | LS | \$ 8,000,000 | \$ 16,000,000 | |
| Transfer Bridge Replacement | <no event> | 15 | 80 | 75.0000 | 2.000 | LS | \$ 2,000,000 | \$ 4,000,000 | |
| Disposal | | | | | | | | | |
| Disposal Cost | <no event> | 1 | 1 | 1.0000 | 1.000 | LS | \$ 0 | \$ 0 | |

Alternative #2

Agency

Initial Construction

| | | | | | | | | | |
|-------------------|------------|---|---|--------|-------|----|---------------|---------------|--|
| Construction cost | <no event> | 5 | 5 | 1.0000 | 1.000 | LS | \$ 62,338,846 | \$ 62,338,846 | |
|-------------------|------------|---|---|--------|-------|----|---------------|---------------|--|

O, M, and R

| | | | | | | | | | |
|--------------------------|------------|----|----|---------|-----------|----|--------------|--------------|--|
| M&O Ferry and Dock | <no event> | 5 | 80 | 1.0000 | 1.000 | LS | \$ 5,800,000 | \$ 5,800,000 | |
| M&O Gravel Road | <no event> | 5 | 80 | 1.0000 | 34408.000 | LS | \$ 4 | \$ 147,954 | |
| Inspection Above Ground | <no event> | 7 | 80 | 2.0000 | 4.000 | LS | \$ 40,000 | \$ 160,000 | |
| Inspection Underwater | <no event> | 10 | 80 | 5.0000 | 4.000 | LS | \$ 25,000 | \$ 100,000 | |
| Guardrail Gravel Road | <no event> | 10 | 80 | 5.0000 | 3441.000 | LS | \$ 117 | \$ 402,597 | |
| Fendering System Repairs | <no event> | 10 | 80 | 5.0000 | 4.000 | LS | \$ 50,000 | \$ 200,000 | |
| Anode Replacement | <no event> | 15 | 80 | 10.0000 | 4.000 | LS | \$ 20,000 | \$ 80,000 | |



Data: Individual Costs

07/06/2012

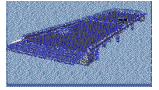

| Item | Event | Start Year | End Year | Frequency | Qtty | Unit of Measure | Unit Cost | Total | Remarks |
|-----------------------------|------------|------------|----------|-----------|----------|-----------------|--------------|---------------|---------|
| Signs/Illumination Gravel | <no event> | 20 | 80 | 15.0000 | 6882.000 | LS | \$ 5 | \$ 34,410 | |
| Recoat Transfer Span | <no event> | 20 | 80 | 15.0000 | 4.000 | LS | \$ 150,000 | \$ 600,000 | |
| Bridge Support-Float Recoat | <no event> | 20 | 80 | 15.0000 | 4.000 | LS | \$ 75,000 | \$ 300,000 | |
| Mooring Structure | <no event> | 40 | 80 | 35.0000 | 4.000 | LS | \$ 1,500,000 | \$ 6,000,000 | |
| Ferry Replacement | <no event> | 40 | 80 | 35.0000 | 3.000 | LS | \$ 8,000,000 | \$ 24,000,000 | |
| Transfer Bridge Replacement | <no event> | 15 | 80 | 75.0000 | 2.000 | LS | \$ 2,000,000 | \$ 4,000,000 | |
| Disposal | | | | | | | | | |
| Disposal cost | <no event> | 80 | 80 | 1.0000 | 1.000 | LS | \$ 0 | \$ 0 | . |

Alternative #3

Agency

Initial Construction

| | | | | | | | | | |
|---------------------------|------------|---|---|--------|-------|----|--------------|--------------|--|
| Freight Dock Construction | <no event> | 5 | 5 | 1.0000 | 1.000 | LS | \$ 5,426,431 | \$ 5,426,431 | |
| Passenger Waiting Area | <no event> | 5 | 5 | 1.0000 | 1.000 | LS | \$ 1,403,387 | \$ 1,403,387 | |
| Ferry Layup Berth | <no event> | 5 | 5 | 1.0000 | 1.000 | LS | \$ 5,987,786 | \$ 5,987,786 | |

O, M, and R

| | | | | | | | | | |
|-----------------------------|------------|----|----|---------|-------|----|--------------|--------------|--|
| M&O Freight Dock | <no event> | 5 | 80 | 1.0000 | 1.000 | LS | \$ 0 | \$ 0 | |
| Inspection Above Ground | <no event> | 7 | 80 | 2.0000 | 1.000 | LS | \$ 40,000 | \$ 40,000 | |
| Inspection Underwater | <no event> | 10 | 80 | 5.0000 | 1.000 | LS | \$ 40,000 | \$ 40,000 | |
| Fendering System Repairs | <no event> | 10 | 80 | 5.0000 | 1.000 | LS | \$ 50,000 | \$ 50,000 | |
| Freight Dock Resurfacing | <no event> | 15 | 80 | 10.0000 | 1.000 | LS | \$ 400,000 | \$ 400,000 | |
| Anode Replacement | <no event> | 15 | 80 | 10.0000 | 1.000 | LS | \$ 100,000 | \$ 100,000 | |
| Recoat Transfer Span | <no event> | 20 | 80 | 15.0000 | 1.000 | LS | \$ 150,000 | \$ 150,000 | |
| Bridge Support-Float Recoat | <no event> | 20 | 80 | 15.0000 | 1.000 | LS | \$ 75,000 | \$ 75,000 | |
| Mooring Structure | <no event> | 40 | 80 | 35.0000 | 1.000 | LS | \$ 1,500,000 | \$ 1,500,000 | |

Disposal

| | | | | | | | | | |
|---------------|------------|----|----|--------|-------|----|------|------|--|
| Disposal cost | <no event> | 80 | 80 | 1.0000 | 1.000 | LS | \$ 0 | \$ 0 | |
|---------------|------------|----|----|--------|-------|----|------|------|--|



Data: Individual Costs

07/06/2012

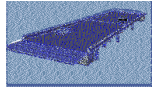

| Item | Event | Start Year | End Year | Frequency | Qty | Unit of Measure | Unit Cost | Total | Remarks |
|-----------------------------|------------|------------|----------|-----------|-----------|-----------------|---------------|---------------|---------|
| Alternative #1 | | | | | | | | | |
| Agency | | | | | | | | | |
| Initial Construction | | | | | | | | | |
| Construction cost | <no event> | 5 | 5 | 1.0000 | 1.000 | LS | \$ 70,046,235 | \$ 70,046,235 | . |
| O, M, and R | | | | | | | | | |
| M&O Ferry and Dock | <no event> | 5 | 80 | 1.0000 | 1.000 | LS | \$ 5,800,000 | \$ 5,800,000 | |
| M&O Paved Road | <no event> | 5 | 80 | 1.0000 | 10180.000 | LS | \$ 4 | \$ 43,774 | |
| M&O Gravel Road | <no event> | 5 | 80 | 1.0000 | 25554.000 | LS | \$ 4 | \$ 109,882 | |
| Inspection Above Ground | <no event> | 7 | 80 | 2.0000 | 4.000 | LS | \$ 40,000 | \$ 160,000 | |
| Inspection Underwater | <no event> | 10 | 80 | 5.0000 | 4.000 | LS | \$ 25,000 | \$ 100,000 | |
| Guardrail Paved Road | <no event> | 10 | 80 | 5.0000 | 5090.000 | LS | \$ 117 | \$ 595,530 | |
| Guardrail Gravel Road | <no event> | 10 | 80 | 5.0000 | 2555.000 | LS | \$ 117 | \$ 298,935 | |
| Fendering System Repairs | <no event> | 10 | 80 | 5.0000 | 4.000 | LS | \$ 50,000 | \$ 200,000 | |
| Pavement Replacement Road | <no event> | 15 | 80 | 10.0000 | 10180.000 | LS | \$ 102 | \$ 1,038,360 | |
| Anode Replacement | <no event> | 15 | 80 | 10.0000 | 4.000 | LS | \$ 20,000 | \$ 80,000 | |
| Signs/Illumination Paved | <no event> | 20 | 80 | 15.0000 | 5090.000 | LS | \$ 5 | \$ 25,450 | |
| Signs/Illumination Gravel | <no event> | 20 | 80 | 15.0000 | 5111.000 | LS | \$ 5 | \$ 25,555 | |
| Recoat Transfer Span | <no event> | 20 | 80 | 15.0000 | 4.000 | LS | \$ 150,000 | \$ 600,000 | |
| Bridge Support-Float Recoat | <no event> | 20 | 80 | 15.0000 | 4.000 | LS | \$ 75,000 | \$ 300,000 | |
| Mooring Structure | <no event> | 40 | 80 | 35.0000 | 4.000 | LS | \$ 1,500,000 | \$ 6,000,000 | |
| Ferry Replacement | <no event> | 40 | 80 | 35.0000 | 3.000 | LS | \$ 8,000,000 | \$ 24,000,000 | |
| Transfer Bridge Replacement | <no event> | 15 | 80 | 75.0000 | 2.000 | LS | \$ 2,000,000 | \$ 4,000,000 | |
| Disposal | | | | | | | | | |
| Disposal cost | <no event> | 80 | 80 | 1.0000 | 1.000 | LS | \$ 0 | \$ 0 | . |



BridgeLCC 2.0 Reports

Ketchikan Gravina Island Access -- G Alignments (w/Revenue)

07/09/2012

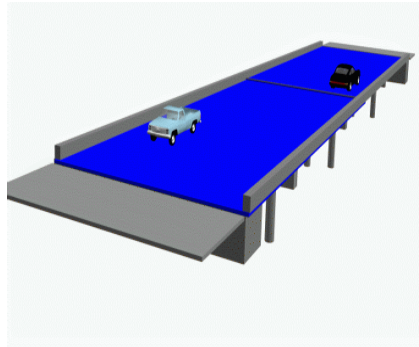

Building and Fire Research Laboratory
National Institute of Standards and Technology
Gaithersburg, MD

Analysis: Summary of Life-Cycle Costs

07/09/2012

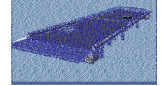

| | Name | Base Case | Alternative #1 | Alternative #2 | Alternative #3 | Alternative #4 | Alternative #5 |
|---------------------------|------------------------------|----------------------|-----------------------|-----------------------|-----------------------|-----------------------|-----------------------|
| | Total Life-Cycle Cost | \$249,040,777 | \$231,747,320 | \$218,479,722 | \$ 15,635,038 | \$115,867,446 | \$118,257,511 |
| By Cost Bearer: | Agency Costs | \$249,040,777 | \$231,747,320 | \$218,479,722 | \$ 15,635,038 | \$115,867,446 | \$118,257,511 |
| | User Costs | \$ 0 | \$ 0 | \$ 0 | \$ 0 | \$ 0 | \$ 0 |
| | Third-Party Costs | \$ 0 | \$ 0 | \$ 0 | \$ 0 | \$ 0 | \$ 0 |
| By Cost Timing: | Initial Construction Costs | \$ 73,961,179 | \$ 63,956,143 | \$ 56,918,864 | \$ 11,703,192 | \$ 20,809,933 | \$ 20,728,308 |
| | OM&R Costs | \$175,079,598 | \$167,791,177 | \$161,560,858 | \$ 3,931,846 | \$ 95,057,513 | \$ 97,529,203 |
| | Disposal Costs | \$ 0 | \$ 0 | \$ 0 | \$ 0 | \$ 0 | \$ 0 |
| By Cost Component: | Elemental Costs | \$249,040,777 | \$231,747,320 | \$218,479,722 | \$ 15,635,038 | \$115,867,446 | \$118,257,511 |
| | Non-elemental Costs | \$ 0 | \$ 0 | \$ 0 | \$ 0 | \$ 0 | \$ 0 |
| | New-Technology | \$ 0 | \$ 0 | \$ 0 | \$ 0 | \$ 0 | \$ 0 |



Data: Description

07/09/2012

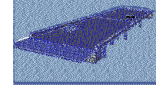

Name: Ketchikan Gravina Island Access -- G Alignments (w/Revenue) **Date:** 07/03/2012

Objective:

Life-cycle costs of the owner's costs, including their tolling income. The average annual income revenue stream from ferry fares (\$2.0 million for G2, G3 and G4; and \$1.5 million for G4v and No Action) has been subtracted from the annual M&O expenses (\$5.8 million for G2, G3 and G4; and \$3.6 million for G4v and No Action) for each G alternative.

The G alternatives (Base Case, and Alternatives #1 and #2) do not include the costs for the new amenities -- passenger waiting area, heavy freight dock and staging area, and ferry layup berth. The life-cycle costs of the new passenger waiting area, heavy freight dock and staging area, and ferry layup berth have been computed separately (Alternative #3). The total life-cycle costs would be the addition of the G alternatives and the amenities:

- G2: \$264,675,815
- G3: \$247,382,358
- G4: \$234,114,760

A modified G4 alternative (G4v) was analyzed, both without a new ferry during the 75 year analysis, and with one ferry added in 2050; Alternative #4 and #5, respectively. Alternative #4 (without ferry) is used in the cost report. With amenities, the total life-cycle cost is:

- G4v: \$131,502,484



Data: Project Parameters

07/09/2012

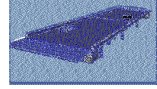

Study Period

| | |
|------------------|------|
| Base Year | 2011 |
| Length of period | 80 |
| Last Year | 2091 |

Currency

U.S. Dollars (\$)

Interest Rates

| | |
|---------------|-------|
| Inflation | 3.77% |
| Real Discount | 2.30% |

Elements

| | |
|----|----------------|
| #1 | Ferry |
| #2 | Dock |
| #3 | Paved Road |
| #4 | Gravel Road |
| #5 | |
| #6 | Non-elemental |
| #7 | New technology |



Data: Alternatives

07/09/2012

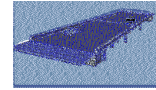

G2 (Peninsula Point)

| | | | |
|-------------------|---|-----------------------|------|
| Number of Ferries | 4 | Area of deck (ft) | 0.00 |
| Number of Docks | 4 | Length of bridge (ft) | 0.00 |

Alignment G2. In addition to the existing two (2) ferries and ferry terminals, provide two (2) new ferries and ferry terminals at Peninsula Point on Revilla Island and Lewis Point on Gravina Island. Included is a new paved road from Lewis Point up the hill to the Seley Road, and then an upgraded and paved Seley Road, and a paved Lewis Reef and Airport Access Roads to the KTN passenger terminal. Also included is the gravel Gravina Island Highway serving the KGB developable lands on Gravina Island.

G3 (Bar Point)

| | | | |
|-------------------|---|-----------------------|------|
| Number of Ferries | 4 | Area of deck (ft) | 0.00 |
| Number of Docks | 4 | Length of bridge (ft) | 0.00 |

Alignment G3. In addition to the existing two (2) ferries and ferry terminals, provide two (2) new ferries and ferry terminals at Bar Point on Jefferson Street near downtown Ketchikan on Revilla Island and near Clump Cove on Gravina Island. Included is a new paved road from Clump Cove up the hill to the Gravina Island Highway, and then across and down the Airport Access Roads to the KTN passenger terminal. Also included are the gravel Gravina Island Highway, Lewis Reef Road and Seley Road serving the KGB developable lands on Gravina Island.

G4 (Charcoal Point)

| | | | |
|-------------------|---|-----------------------|------|
| Number of Ferries | 4 | Area of deck (ft) | 0.00 |
| Number of Docks | 4 | Length of bridge (ft) | 0.00 |

Alignment G4. In addition to the existing two (2) ferries and ferry terminals, provide two (2) new ferries and ferry terminals adjacent to the existing terminals on Revilla and Gravina islands at the crossing of Tongass Narrows to the KTN passenger terminal. Also included are the gravel Gravina Island Highway, Lewis Reef Road and Seley Road serving the KGB developable lands on Gravina Island.

Waiting Area, Freight Dock & Layup Berth

| | | | |
|-------------------|---|-----------------------|------|
| Number of Ferries | 0 | Area of deck (ft) | 0.00 |
| Number of Docks | 1 | Length of bridge (ft) | 0.00 |

This work includes construction of a passenger waiting terminal and baggage handling facility (including shuttle vans, etc) at Charcoal Point.

Included in the work is a heavy freight dock and 2.5 acre staging area on Gravina Island for oversize and overweight loads that cannot be accommodated on the current shuttle ferries, at a location just south of the



Data: Alternatives

07/09/2012

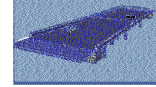

existing ferry terminal. This dock will also be capable of laying over AMHS-class ferries.

Additionally, the replacement of the current I-90 floating dock with a new floating dock that will allow for tying off the airport shuttle ferries. The berth will be located between the Gravina Island ferry dock and the heavy freight dock.

| G4v (Charcoal Point) w/o new Ferry | | | |
|---|---|-----------------------|------|
| Number of Ferries | 2 | Area of deck (ft) | 0.00 |
| Number of Docks | 2 | Length of bridge (ft) | 0.00 |

Alignment G4v. Continuation of operation of the existing two (2) ferries and ferry terminals. Two (2) new ferries and ferry terminals adjacent to the existing terminals on Revilla and Gravina islands at the crossing of Tongass Narrows to the KTN passenger terminal will be added at some future date WHEN TRAFFIC WARRANTS a system expansion -- beyond the term of this analysis. Also included are the gravel Gravina Island Highway, Lewis Reef Road and Seley Road serving the KGB developable lands on Gravina Island.

| G4v (Charcoal Point) w/ new Ferry | | | |
|--|---|-----------------------|------|
| Number of Ferries | 3 | Area of deck (ft) | 0.00 |
| Number of Docks | 2 | Length of bridge (ft) | 0.00 |

Alignment G4v. Continuation of operation of the existing two (2) ferries and ferry terminals. Two (2) new ferries and ferry terminals adjacent to the existing terminals on Revilla and Gravina islands at the crossing of Tongass Narrows to the KTN passenger terminal will be added at some future date when traffic warrants a system expansion -- one (1) new ferry and two (2) ferry terminals are assumed to be ADDED AT THE MID-LIFE (2050), for a total of three (3) ferries operating together between four (4) terminals. Also included are the gravel Gravina Island Highway, Lewis Reef Road and Seley Road serving the KGB developable lands on Gravina Island.



Data: Individual Costs

07/09/2012

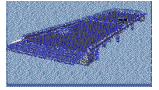

| Item | Event | Start Year | End Year | Frequency | Qty | Unit of Measure | Unit Cost | Total | Remarks |
|-----------------------------|------------|------------|----------|-----------|-----------|-----------------|---------------|---------------|---------|
| Base Case | | | | | | | | | |
| Agency | | | | | | | | | |
| Initial Construction | | | | | | | | | |
| Construction cost | <no event> | 5 | 5 | 1.0000 | 1.000 | LS | \$ 81,003,981 | \$ 81,003,981 | . |
| Disposal | | | | | | | | | |
| Disposal cost | <no event> | 80 | 80 | 1.0000 | 1.000 | LS | \$ 0 | \$ 0 | . |
| O, M, and R | | | | | | | | | |
| M&O Paved Road | <no event> | 5 | 80 | 1.0000 | 21675.000 | LS | \$ 4 | \$ 93,203 | |
| M&O Gravel Road | <no event> | 5 | 80 | 1.0000 | 16714.000 | LS | \$ 4 | \$ 71,870 | |
| Inspection Above Ground | <no event> | 7 | 80 | 2.0000 | 4.000 | LS | \$ 40,000 | \$ 160,000 | |
| Inspection Underwater | <no event> | 10 | 80 | 5.0000 | 4.000 | LS | \$ 25,000 | \$ 100,000 | |
| Guardrail Paved Road | <no event> | 10 | 80 | 5.0000 | 10838.000 | LS | \$ 117 | \$ 1,268,046 | |
| Guardrail Gravel Road | <no event> | 10 | 80 | 5.0000 | 1671.000 | LS | \$ 117 | \$ 195,507 | |
| Fendering System Repairs | <no event> | 10 | 80 | 5.0000 | 4.000 | LS | \$ 50,000 | \$ 200,000 | |
| Pavement Replacement Road | <no event> | 15 | 80 | 10.0000 | 21675.000 | LS | \$ 102 | \$ 2,210,850 | |
| Anode Replacement | <no event> | 15 | 80 | 10.0000 | 4.000 | LS | \$ 20,000 | \$ 80,000 | |
| Signs/Illumination Paved | <no event> | 20 | 80 | 15.0000 | 10838.000 | LS | \$ 5 | \$ 54,190 | |
| Signs/Illumination Gravel | <no event> | 20 | 80 | 15.0000 | 3343.000 | LS | \$ 5 | \$ 16,715 | |
| Recoat Transfer Span | <no event> | 20 | 80 | 15.0000 | 4.000 | LS | \$ 150,000 | \$ 600,000 | |
| Bridge Support Float Recoat | <no event> | 20 | 80 | 15.0000 | 4.000 | LS | \$ 75,000 | \$ 300,000 | |
| Mooring Structure | <no event> | 40 | 80 | 35.0000 | 4.000 | LS | \$ 1,500,000 | \$ 6,000,000 | |
| Ferry Replacement | <no event> | 40 | 80 | 35.0000 | 3.000 | LS | \$ 8,000,000 | \$ 24,000,000 | |
| Transfer Bridge Replacement | <no event> | 15 | 80 | 75.0000 | 2.000 | LS | \$ 2,000,000 | \$ 4,000,000 | |
| M&O Ferry and Dock | <no event> | 5 | 80 | 1.0000 | 1.000 | LS | \$ 5,800,000 | \$ 5,800,000 | |
| Toll Revenue | <no event> | 5 | 80 | 1.0000 | 1.000 | LS | \$ -2,000,000 | \$ -2,000,000 | |

Alternative #5

Data: Individual Costs

07/09/2012

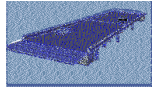

| Item | Event | Start Year | End Year | Frequency | Qty | Unit of Measure | Unit Cost | Total | Remarks |
|-----------------------------|------------|------------|----------|-----------|-----------|-----------------|---------------|---------------|------------------|
| Agency | | | | | | | | | |
| Initial Construction | | | | | | | | | |
| Initial Construction Cost | <no event> | 5 | 5 | 1.0000 | 1.000 | LS | \$ 9,027,000 | \$ 9,027,000 | |
| Two More Docks Construction | <no event> | 40 | 80 | 75.0000 | 1.000 | LS | \$ 18,700,000 | \$ 18,700,000 | |
| One More Ferry Construction | <no event> | 40 | 80 | 35.0000 | 1.000 | LS | \$ 8,000,000 | \$ 8,000,000 | |
| O, M, and R | | | | | | | | | |
| M&O Ferry and Dock | <no event> | 5 | 80 | 1.0000 | 1.000 | LS | \$ 3,600,000 | \$ 3,600,000 | |
| M&O Gravel Road | <no event> | 5 | 80 | 1.0000 | 34408.000 | LS | \$ 4 | \$ 147,954 | |
| Inspection Above Ground | <no event> | 7 | 80 | 2.0000 | 3.000 | LS | \$ 40,000 | \$ 120,000 | Quantity assumes |
| Inspection Underwater | <no event> | 10 | 80 | 5.0000 | 3.000 | LS | \$ 25,000 | \$ 75,000 | Quantity assumes |
| Guardrail Gravel Road | <no event> | 10 | 80 | 5.0000 | 3441.000 | LS | \$ 117 | \$ 402,597 | |
| Fendering System Repairs | <no event> | 10 | 80 | 5.0000 | 3.000 | LS | \$ 50,000 | \$ 150,000 | Quantity assumes |
| Anode Replacement | <no event> | 15 | 80 | 10.0000 | 3.000 | LS | \$ 20,000 | \$ 60,000 | Quantity assumes |
| Signs/Illumination Gravel | <no event> | 20 | 80 | 15.0000 | 6882.000 | LS | \$ 5 | \$ 34,410 | |
| Recoat Transfer Span | <no event> | 20 | 80 | 15.0000 | 3.000 | LS | \$ 150,000 | \$ 450,000 | Quantity assumes |
| Bridge Support Float Recoat | <no event> | 20 | 80 | 15.0000 | 3.000 | LS | \$ 75,000 | \$ 225,000 | Quantity assumes |
| Mooring Structure | <no event> | 40 | 80 | 35.0000 | 3.000 | LS | \$ 1,500,000 | \$ 4,500,000 | Quantity assumes |
| Ferry Replacement | <no event> | 40 | 80 | 35.0000 | 2.000 | LS | \$ 8,000,000 | \$ 16,000,000 | |
| Transfer Bridge Replacement | <no event> | 15 | 80 | 75.0000 | 2.000 | LS | \$ 2,000,000 | \$ 4,000,000 | |
| Toll Revenue | <no event> | 5 | 80 | 1.0000 | 1.000 | LS | \$ -1,500,000 | \$ -1,500,000 | |
| Disposal | | | | | | | | | |
| Disposal Cost | <no event> | 80 | 80 | 1.0000 | 1.000 | LS | \$ 0 | \$ 0 | |

Alternative #4

| | | | | | | | | | |
|---------------------------|------------|---|---|--------|-------|----|---------------|---------------|--|
| Agency | | | | | | | | | |
| Initial Construction | | | | | | | | | |
| Initial Construction Cost | <no event> | 5 | 5 | 1.0000 | 1.000 | LS | \$ 22,791,516 | \$ 22,791,516 | |



Data: Individual Costs

07/09/2012

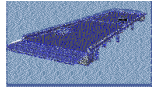

| Item | Event | Start Year | End Year | Frequency | Qty | Unit of Measure | Unit Cost | Total | Remarks |
|-----------------------------|------------|------------|----------|-----------|-----------|-----------------|---------------|---------------|---------|
| O, M, and R | | | | | | | | | |
| M&O Ferry and Dock | <no event> | 5 | 80 | 1.0000 | 1.000 | LS | \$ 3,600,000 | \$ 3,600,000 | |
| M&O Gravel Road | <no event> | 5 | 80 | 1.0000 | 34408.000 | LS | \$ 4 | \$ 147,954 | |
| Inspection Above Ground | <no event> | 7 | 80 | 2.0000 | 2.000 | LS | \$ 40,000 | \$ 80,000 | |
| Inspection Underwater | <no event> | 10 | 80 | 5.0000 | 2.000 | LS | \$ 25,000 | \$ 50,000 | |
| Guardrail Gravel Road | <no event> | 10 | 80 | 5.0000 | 3441.000 | LS | \$ 117 | \$ 402,597 | |
| Fendering System Repairs | <no event> | 10 | 80 | 5.0000 | 2.000 | LS | \$ 50,000 | \$ 100,000 | |
| Anode Replacement | <no event> | 15 | 80 | 10.0000 | 2.000 | LS | \$ 20,000 | \$ 40,000 | |
| Signs/Illumination Gravel | <no event> | 20 | 80 | 15.0000 | 6882.000 | LS | \$ 5 | \$ 34,410 | |
| Recoat Transfer Span | <no event> | 20 | 80 | 15.0000 | 2.000 | LS | \$ 150,000 | \$ 300,000 | |
| Bridge Support Float Recoat | <no event> | 20 | 80 | 15.0000 | 2.000 | LS | \$ 75,000 | \$ 150,000 | |
| Mooring Structure | <no event> | 40 | 80 | 35.0000 | 2.000 | LS | \$ 1,500,000 | \$ 3,000,000 | |
| Ferry Replacement | <no event> | 40 | 80 | 35.0000 | 2.000 | LS | \$ 8,000,000 | \$ 16,000,000 | |
| Transfer Bridge Replacement | <no event> | 15 | 80 | 75.0000 | 2.000 | LS | \$ 2,000,000 | \$ 4,000,000 | |
| Toll Revenue | <no event> | 5 | 80 | 1.0000 | 1.000 | LS | \$ -1,500,000 | \$ -1,500,000 | |
| Disposal | | | | | | | | | |
| Disposal Cost | <no event> | 80 | 80 | 1.0000 | 1.000 | LS | \$ 0 | \$ 0 | |

Alternative #2

| | | | | | | | | | |
|-------------------------|------------|----|----|--------|-----------|----|---------------|---------------|--|
| Agency | | | | | | | | | |
| Initial Construction | | | | | | | | | |
| Construction cost | <no event> | 5 | 5 | 1.0000 | 1.000 | LS | \$ 62,338,846 | \$ 62,338,846 | |
| O, M, and R | | | | | | | | | |
| M&O Ferry and Dock | <no event> | 5 | 80 | 1.0000 | 1.000 | LS | \$ 5,800,000 | \$ 5,800,000 | |
| M&O Gravel Road | <no event> | 5 | 80 | 1.0000 | 34408.000 | LS | \$ 4 | \$ 147,954 | |
| Inspection Above Ground | <no event> | 7 | 80 | 2.0000 | 4.000 | LS | \$ 40,000 | \$ 160,000 | |
| Inspection Underwater | <no event> | 10 | 80 | 5.0000 | 4.000 | LS | \$ 25,000 | \$ 100,000 | |



Data: Individual Costs

07/09/2012

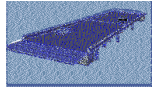

| Item | Event | Start Year | End Year | Frequency | Qty | Unit of Measure | Unit Cost | Total | Remarks |
|-----------------------------|------------|------------|----------|-----------|----------|-----------------|---------------|---------------|---------|
| Guardrail Gravel Road | <no event> | 10 | 80 | 5.0000 | 3441.000 | LS | \$ 117 | \$ 402,597 | |
| Fendering System Repairs | <no event> | 10 | 80 | 5.0000 | 4.000 | LS | \$ 50,000 | \$ 200,000 | |
| Anode Replacement | <no event> | 15 | 80 | 10.0000 | 4.000 | LS | \$ 20,000 | \$ 80,000 | |
| Signs/Illumination Gravel | <no event> | 20 | 80 | 15.0000 | 6882.000 | LS | \$ 5 | \$ 34,410 | |
| Recoat Transfer Span | <no event> | 20 | 80 | 15.0000 | 4.000 | LS | \$ 150,000 | \$ 600,000 | |
| Bridge Support Float Recoat | <no event> | 20 | 80 | 15.0000 | 4.000 | LS | \$ 75,000 | \$ 300,000 | |
| Mooring Structure | <no event> | 40 | 80 | 35.0000 | 4.000 | LS | \$ 1,500,000 | \$ 6,000,000 | |
| Ferry Replacement | <no event> | 40 | 80 | 35.0000 | 3.000 | LS | \$ 8,000,000 | \$ 24,000,000 | |
| Transfer Bridge Replacement | <no event> | 15 | 80 | 75.0000 | 2.000 | LS | \$ 2,000,000 | \$ 4,000,000 | |
| Toll Revenue | <no event> | 5 | 80 | 1.0000 | 1.000 | LS | \$ -2,000,000 | \$ -2,000,000 | |
| Disposal | | | | | | | | | |
| Disposal cost | <no event> | 80 | 80 | 1.0000 | 1.000 | LS | \$ 0 | \$ 0 | |

Alternative #3

Agency

Initial Construction

| | | | | | | | | | |
|---------------------------|------------|---|---|--------|-------|----|--------------|--------------|--|
| Freight Dock Construction | <no event> | 5 | 5 | 1.0000 | 1.000 | LS | \$ 5,426,431 | \$ 5,426,431 | |
| Passenger Waiting Area | <no event> | 5 | 5 | 1.0000 | 1.000 | LS | \$ 1,403,387 | \$ 1,403,387 | |
| Ferry Layup Berth | <no event> | 5 | 5 | 1.0000 | 1.000 | LS | \$ 5,987,786 | \$ 5,987,786 | |

O, M, and R

| | | | | | | | | | |
|--------------------------|------------|----|----|---------|-------|----|------------|------------|--|
| M&O Freight Dock | <no event> | 5 | 80 | 1.0000 | 1.000 | LS | \$ 0 | \$ 0 | |
| Inspection Above Ground | <no event> | 7 | 80 | 2.0000 | 1.000 | LS | \$ 40,000 | \$ 40,000 | |
| Inspection Underwater | <no event> | 10 | 80 | 5.0000 | 1.000 | LS | \$ 40,000 | \$ 40,000 | |
| Fendering System Repairs | <no event> | 10 | 80 | 5.0000 | 1.000 | LS | \$ 50,000 | \$ 50,000 | |
| Freight Dock Resurfacing | <no event> | 15 | 80 | 10.0000 | 1.000 | LS | \$ 400,000 | \$ 400,000 | |
| Anode Replacement | <no event> | 15 | 80 | 10.0000 | 1.000 | LS | \$ 100,000 | \$ 100,000 | |
| Recoat Transfer Span | <no event> | 20 | 80 | 15.0000 | 1.000 | LS | \$ 150,000 | \$ 150,000 | |



Data: Individual Costs

07/09/2012

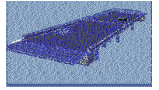

| Item | Event | Start Year | End Year | Frequency | Qty | Unit of Measure | Unit Cost | Total | Remarks |
|-----------------------------|------------|------------|----------|-----------|-------|-----------------|--------------|--------------|---------|
| Bridge Support-Float Recoat | <no event> | 20 | 80 | 15.0000 | 1.000 | LS | \$ 75,000 | \$ 75,000 | |
| Mooring Structure | <no event> | 40 | 80 | 35.0000 | 1.000 | LS | \$ 1,500,000 | \$ 1,500,000 | |
| Disposal | | | | | | | | | |
| Disposal cost | <no event> | 80 | 80 | 1.0000 | 1.000 | LS | \$ 0 | \$ 0 | |

Alternative #1

Agency

Initial Construction

| | | | | | | | | | |
|-------------------|------------|---|---|--------|-------|----|---------------|---------------|--|
| Construction cost | <no event> | 5 | 5 | 1.0000 | 1.000 | LS | \$ 70,046,235 | \$ 70,046,235 | |
|-------------------|------------|---|---|--------|-------|----|---------------|---------------|--|

O, M, and R

| | | | | | | | | | |
|-----------------------------|------------|----|----|---------|-----------|----|--------------|---------------|--|
| M&O Ferry and Dock | <no event> | 5 | 80 | 1.0000 | 1.000 | LS | \$ 5,800,000 | \$ 5,800,000 | |
| M&O Paved Road | <no event> | 5 | 80 | 1.0000 | 10180.000 | LS | \$ 4 | \$ 43,774 | |
| M&O Gravel Road | <no event> | 5 | 80 | 1.0000 | 25554.000 | LS | \$ 4 | \$ 109,882 | |
| Inspection Above Ground | <no event> | 7 | 80 | 2.0000 | 4.000 | LS | \$ 40,000 | \$ 160,000 | |
| Inspection Underwater | <no event> | 10 | 80 | 5.0000 | 4.000 | LS | \$ 25,000 | \$ 100,000 | |
| Guardrail Paved Road | <no event> | 10 | 80 | 5.0000 | 5090.000 | LS | \$ 117 | \$ 595,530 | |
| Guardrail Gravel Road | <no event> | 10 | 80 | 5.0000 | 2555.000 | LS | \$ 117 | \$ 298,935 | |
| Fendering System Repairs | <no event> | 10 | 80 | 5.0000 | 4.000 | LS | \$ 50,000 | \$ 200,000 | |
| Pavement Replacement Road | <no event> | 15 | 80 | 10.0000 | 10180.000 | LS | \$ 102 | \$ 1,038,360 | |
| Anode Replacement | <no event> | 15 | 80 | 10.0000 | 4.000 | LS | \$ 20,000 | \$ 80,000 | |
| Signs/Illumination Paved | <no event> | 20 | 80 | 15.0000 | 5090.000 | LS | \$ 5 | \$ 25,450 | |
| Signs/Illumination Gravel | <no event> | 20 | 80 | 15.0000 | 5111.000 | LS | \$ 5 | \$ 25,555 | |
| Recoat Transfer Span | <no event> | 20 | 80 | 15.0000 | 4.000 | LS | \$ 150,000 | \$ 600,000 | |
| Bridge Support Float Recoat | <no event> | 20 | 80 | 15.0000 | 4.000 | LS | \$ 75,000 | \$ 300,000 | |
| Mooring Structure | <no event> | 40 | 80 | 35.0000 | 4.000 | LS | \$ 1,500,000 | \$ 6,000,000 | |
| Ferry Replacement | <no event> | 40 | 80 | 35.0000 | 3.000 | LS | \$ 8,000,000 | \$ 24,000,000 | |
| Transfer Bridge Replacement | <no event> | 15 | 80 | 75.0000 | 2.000 | LS | \$ 2,000,000 | \$ 4,000,000 | |



Data: Individual Costs

07/09/2012

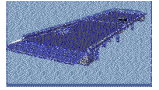

| Item | Event | Start Year | End Year | Frequency | Qty | Unit of Measure | Unit Cost | Total | Remarks |
|---------------|------------|------------|----------|-----------|-------|-----------------|---------------|---------------|---------|
| Toll Revenue | <no event> | 5 | 80 | 1.0000 | 1.000 | LS | \$ -2,000,000 | \$ -2,000,000 | |
| Disposal | | | | | | | | | |
| Disposal cost | <no event> | 80 | 80 | 1.0000 | 1.000 | LS | \$ 0 | \$ 0 | . |



BridgeLCC 2.0 Reports

Ketchikan Gravina Island Access -- No-Build (w/o Revenue)

11/03/2011

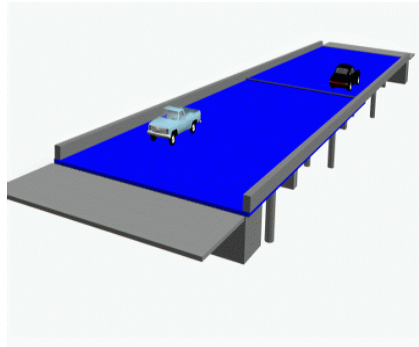

Building and Fire Research Laboratory
National Institute of Standards and Technology
Gaithersburg, MD

Analysis: Summary of Life-Cycle Costs

11/03/2011

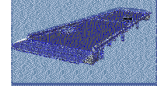

| | Name | Base Case |
|---------------------------|------------------------------|----------------------|
| | Total Life-Cycle Cost | \$ 88,018,416 |
| By Cost Bearer: | Agency Costs | \$ 88,018,416 |
| | User Costs | \$ 0 |
| | Third-Party Costs | \$ 0 |
| By Cost Timing: | Initial Construction Costs | \$ 0 |
| | OM&R Costs | \$ 88,018,416 |
| | Disposal Costs | \$ 0 |
| By Cost Component: | Elemental Costs | \$ 88,018,416 |
| | Non-elemental Costs | \$ 0 |
| | New-Technology | \$ 0 |



Data: Description

11/03/2011

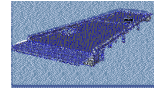

Name: Ketchikan Gravina Island Access -- No-Build (w/o Revenue)

Date: 10/07/2011

Objective:

No-Build Alternative. Under the no-build, there will be no improvements to the existing ferry system service. Maintenance will continue at its present level, but no system expansion will be made other than normal repairs and replacements.

Also included will be the continuing normal and routine maintenance of the gravel Gravina Island Highway, Lewis Reef Road and Seley Road accesses to the KGB developable lands on Gravina Island.

This analysis does not include revenue collected from ferry fares.



Data: Project Parameters

11/03/2011

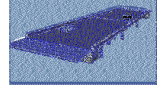

Study Period

| | |
|------------------|------|
| Base Year | 2011 |
| Length of period | 80 |
| Last Year | 2091 |

Currency

U.S. Dollars (\$)

Interest Rates

| | |
|---------------|-------|
| Inflation | 3.77% |
| Real Discount | 2.30% |

Elements

| | |
|----|----------------|
| #1 | Ferry |
| #2 | Dock |
| #3 | Gravel Road |
| #4 | |
| #5 | |
| #6 | Non-elemental |
| #7 | New technology |



Data: Alternatives

11/03/2011

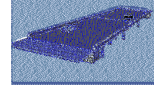

No-Build (w/o Revenue)

| | | | |
|-------------|---|-----------------------|------|
| Lanes on | 2 | Area of deck (ft) | 0.00 |
| Lanes under | 0 | Length of bridge (ft) | 0.00 |

No-Build Alternative. Under the no-build, there will be no improvements to the existing ferry system service. Maintenance will continue at its present level, but no system expansion will be made other than normal repairs and replacements.

Also included will be the continuing normal and routine maintenance of the gravel Gravina Island Highway, Lewis Reef Road and Seley Road accesses to the KGB developable lands on Gravina Island.

This analysis does not include revenue collected from ferry fares.



Data: Individual Costs

11/03/2011

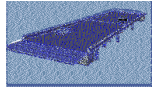

| Item | Event | Start Year | End Year | Frequency | Qty | Unit of Measure | Unit Cost | Total | Remarks |
|-------------------------------|------------|------------|----------|-----------|-----------|-----------------|--------------|---------------|---------|
| Base Case | | | | | | | | | |
| Agency | | | | | | | | | |
| Initial Construction | | | | | | | | | |
| Construction cost | <no event> | 3 | 3 | 1.0000 | 1.000 | LS | \$ 0 | \$ 0 | . |
| Disposal | | | | | | | | | |
| Disposal cost | <no event> | 80 | 80 | 1.0000 | 1.000 | LS | \$ 0 | \$ 0 | . |
| O, M, and R | | | | | | | | | |
| M&O Ferry and Dock | <no event> | 3 | 80 | 1.0000 | 1.000 | LS | \$ 1,800,000 | \$ 1,800,000 | |
| M&O Gravel Road | <no event> | 3 | 80 | 1.0000 | 34408.000 | LS | \$ 4 | \$ 147,954 | |
| Inspection Above Ground | <no event> | 5 | 80 | 2.0000 | 2.000 | LS | \$ 40,000 | \$ 80,000 | |
| Inspection Underwater | <no event> | 8 | 80 | 5.0000 | 2.000 | LS | \$ 25,000 | \$ 50,000 | |
| Guardrail Gravel Road | <no event> | 8 | 80 | 5.0000 | 3441.000 | LS | \$ 117 | \$ 402,597 | |
| Fendering System Repairs | <no event> | 8 | 80 | 5.0000 | 2.000 | LS | \$ 50,000 | \$ 100,000 | |
| Anode Replacement | <no event> | 13 | 80 | 10.0000 | 2.000 | LS | \$ 20,000 | \$ 40,000 | |
| Sign/Illumination Replacement | <no event> | 18 | 80 | 15.0000 | 6882.000 | LS | \$ 5 | \$ 34,410 | |
| Recoat Transfer Span | <no event> | 18 | 80 | 15.0000 | 2.000 | LS | \$ 150,000 | \$ 300,000 | |
| Bridge Support Float Recoat | <no event> | 18 | 80 | 15.0000 | 2.000 | LS | \$ 75,000 | \$ 150,000 | |
| Mooring Structure | <no event> | 38 | 80 | 35.0000 | 2.000 | LS | \$ 1,500,000 | \$ 3,000,000 | |
| Ferry Replacement | <no event> | 35 | 80 | 35.0000 | 2.000 | LS | \$ 8,000,000 | \$ 16,000,000 | |
| Transfer Bridge Replacement | <no event> | 78 | 80 | 75.0000 | 2.000 | LS | \$ 2,000,000 | \$ 4,000,000 | |



BridgeLCC 2.0 Reports

Ketchikan Gravina Island Access -- No-Build (w/ Revenue)

11/03/2011

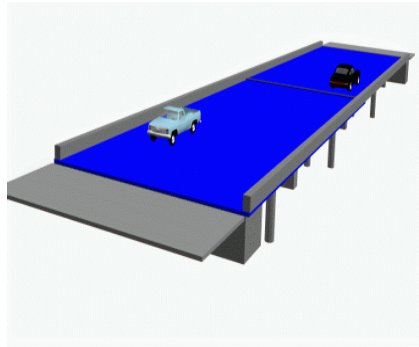

Building and Fire Research Laboratory
National Institute of Standards and Technology
Gaithersburg, MD

Analysis: Summary of Life-Cycle Costs

11/03/2011

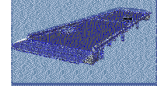

| | Name | Base Case |
|---------------------------|------------------------------|----------------------|
| | Total Life-Cycle Cost | \$ 35,086,028 |
| By Cost Bearer: | Agency Costs | \$ 35,086,028 |
| | User Costs | \$ 0 |
| | Third-Party Costs | \$ 0 |
| By Cost Timing: | Initial Construction Costs | \$ 0 |
| | OM&R Costs | \$ 35,086,028 |
| | Disposal Costs | \$ 0 |
| By Cost Component: | Elemental Costs | \$ 35,086,028 |
| | Non-elemental Costs | \$ 0 |
| | New-Technology | \$ 0 |



Data: Description

11/03/2011

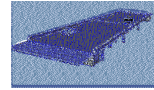

Name: Ketchikan Gravina Island Access -- No-Build (w/ Revenue)

Date: 10/07/2011

Objective:

No-Build Alternative. Under the no-build, there will be no improvements to the existing ferry system service. Maintenance will continue at its present level, but no system expansion will be made other than normal repairs and replacements.

The maintenance costs reflected herein includes the revenue obtained from ticket sales (\$1,500,000).

Also included will be the continuing normal and routine maintenance of the gravel Gravina Island Highway, Lewis Reef Road and Seley Road accesses to the KGB developable lands on Gravina Island.



Data: Project Parameters

11/03/2011

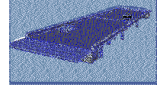

Study Period

| | |
|------------------|------|
| Base Year | 2011 |
| Length of period | 80 |
| Last Year | 2091 |

Currency

U.S. Dollars (\$)

Interest Rates

| | |
|---------------|-------|
| Inflation | 3.77% |
| Real Discount | 2.30% |

Elements

| | |
|----|----------------|
| #1 | Ferry |
| #2 | Dock |
| #3 | Gravel Road |
| #4 | |
| #5 | |
| #6 | Non-elemental |
| #7 | New technology |



Data: Alternatives

11/03/2011

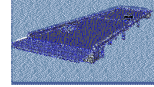

No-Build (w/Revenue)

| | | | |
|-------------|---|-----------------------|------|
| Lanes on | 2 | Area of deck (ft) | 0.00 |
| Lanes under | 0 | Length of bridge (ft) | 0.00 |

No-Build Alternative. Under the no-build, there will be no improvements to the existing ferry system service. Maintenance will continue at its present level, but no system expansion will be made other than normal repairs and replacements.

The maintenance costs reflected herein includes the revenue obtained from ticket sales (\$1,500,000).

Also included will be the continuing normal and routine maintenance of the gravel Gravina Island Highway, Lewis Reef Road and Seley Road accesses to the KGB developable lands on Gravina Island.



Data: Individual Costs

11/03/2011

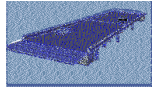

| Item | Event | Start Year | End Year | Frequency | Qty | Unit of Measure | Unit Cost | Total | Remarks |
|-------------------------------|------------|------------|----------|-----------|-----------|-----------------|---------------|---------------|---------|
| Base Case | | | | | | | | | |
| Agency | | | | | | | | | |
| Initial Construction | | | | | | | | | |
| Construction cost | <no event> | 3 | 3 | 1.0000 | 1.000 | LS | \$ 0 | \$ 0 | . |
| Disposal | | | | | | | | | |
| Disposal cost | <no event> | 80 | 80 | 1.0000 | 1.000 | LS | \$ 0 | \$ 0 | . |
| O, M, and R | | | | | | | | | |
| M&O Ferry and Dock | <no event> | 3 | 80 | 1.0000 | 1.000 | LS | \$ 1,800,000 | \$ 1,800,000 | |
| M&O Gravel Road | <no event> | 3 | 80 | 1.0000 | 34406.000 | LS | \$ 4 | \$ 147,946 | |
| Inspection Above Ground | <no event> | 5 | 80 | 2.0000 | 2.000 | LS | \$ 40,000 | \$ 80,000 | |
| Inspection Underwater | <no event> | 8 | 80 | 5.0000 | 2.000 | LS | \$ 25,000 | \$ 50,000 | |
| Guardrail Gravel Road | <no event> | 8 | 80 | 5.0000 | 3441.000 | LS | \$ 117 | \$ 402,597 | |
| Fendering System Repairs | <no event> | 8 | 80 | 5.0000 | 2.000 | LS | \$ 50,000 | \$ 100,000 | |
| Anode Replacement | <no event> | 13 | 80 | 10.0000 | 2.000 | LS | \$ 20,000 | \$ 40,000 | |
| Sign/Illumination Replacement | <no event> | 18 | 80 | 15.0000 | 6882.000 | LS | \$ 5 | \$ 34,410 | |
| Recoat Transfer Span | <no event> | 18 | 80 | 15.0000 | 2.000 | LS | \$ 150,000 | \$ 300,000 | |
| Bridge Support Float Recoat | <no event> | 18 | 80 | 15.0000 | 2.000 | LS | \$ 75,000 | \$ 150,000 | |
| Mooring Structure | <no event> | 38 | 80 | 35.0000 | 2.000 | LS | \$ 1,500,000 | \$ 3,000,000 | |
| Ferry Replacement | <no event> | 35 | 80 | 35.0000 | 2.000 | LS | \$ 8,000,000 | \$ 16,000,000 | |
| Transfer Bridge Replacement | <no event> | 78 | 80 | 75.0000 | 2.000 | LS | \$ 2,000,000 | \$ 4,000,000 | |
| Toll Revenue | <no event> | 3 | 80 | 1.0000 | 1.000 | LS | \$ -1,500,000 | \$ -1,500,000 | |



BridgeLCC 2.0 Reports

Ketchikan Gravina Island Access -- Toll Collection

11/03/2011

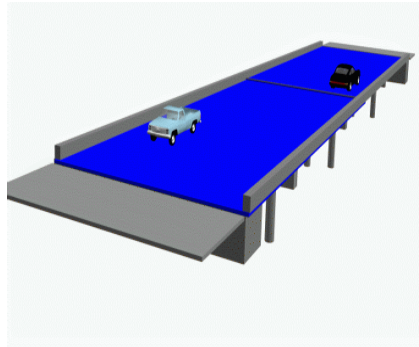

Building and Fire Research Laboratory
National Institute of Standards and Technology
Gaithersburg, MD

Analysis: Summary of Life-Cycle Costs

11/03/2011

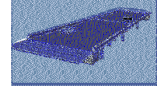

| | Name | Base Case | Alternative #1 | Alternative #2 |
|---------------------------|------------------------------|----------------------|-----------------------|-----------------------|
| | Total Life-Cycle Cost | \$ 35,249,397 | \$ 35,176,991 | \$ 5,082,174 |
| By Cost Bearer: | Agency Costs | \$ 35,249,397 | \$ 35,176,991 | \$ 5,082,174 |
| | User Costs | \$ 0 | \$ 0 | \$ 0 |
| | Third-Party Costs | \$ 0 | \$ 0 | \$ 0 |
| By Cost Timing: | Initial Construction Costs | \$ 181,013 | \$ 108,608 | \$ 72,405 |
| | OM&R Costs | \$ 35,068,383 | \$ 35,068,383 | \$ 5,009,769 |
| | Disposal Costs | \$ 0 | \$ 0 | \$ 0 |
| By Cost Component: | Elemental Costs | \$ 0 | \$ 0 | \$ 0 |
| | Non-elemental Costs | \$ 35,249,397 | \$ 35,176,991 | \$ 5,082,174 |
| | New-Technology | \$ 0 | \$ 0 | \$ 0 |



Data: Description

11/03/2011

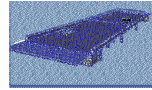

Name: Ketchikan Gravina Island Access -- Toll Collection

Date: 10/07/2011

Objective:

The addition of toll collection to the bridged crossings C3-4 and F3-1. The collection methodology will be either manned toll booths or an electron fare collection system. Toll booths will require an additional outbound lane; electronic collection requires no additional laneage. Both options will require an administrative office to handle billings and enforcement notices.



Data: Project Parameters

11/03/2011

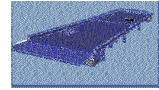

Study Period

| | |
|------------------|------|
| Base Year | 2011 |
| Length of period | 80 |
| Last Year | 2091 |

Currency

U.S. Dollars (\$)

Interest Rates

| | |
|---------------|-------|
| Inflation | 3.77% |
| Real Discount | 2.30% |

Elements

| | |
|----|----------------|
| #1 | |
| #2 | |
| #3 | |
| #4 | |
| #5 | |
| #6 | Non-elemental |
| #7 | New technology |



Data: Alternatives

11/03/2011

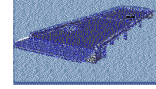

C3-4 Toll Booth Collection

| | | | |
|----------|---|------|------|
| Lanes on | 3 | (ft) | 0.00 |
| | 0 | (ft) | 0.00 |

The widening of the Revilla Island bound lane for toll booths at the base of the Tongass Narrows bridge approach. Work includes an additional lane and two collection booths. A small administrative office will also be needed at the Department's M&O yard.

F3-1 Toll Booth Collection

| | | | |
|----------|---|------|------|
| Lanes on | 3 | (ft) | 0.00 |
| | 0 | (ft) | 0.00 |

The widening of the Revilla Island bound lane for toll booths between the Pennock Island access intersection and the East Channel bridge aboutment. Work includes an additional lane and two collection booths. A small administrative office will also be needed at the Department's M&O yard.

Electronic Toll Collection

| | | | |
|----------|---|------|------|
| Lanes on | 2 | (ft) | 0.00 |
| | 0 | (ft) | 0.00 |

The construction of an electronic collection system on either the C3-4 or F3-1 bridge approaches. Work includes installation of pole-mounted readers and "run through" violation enforcement cameras. A small administrative office will also be needed at the Department's M&O yard.



Data: Individual Costs

11/03/2011

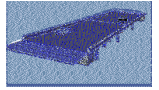

| Item | Event | Start Year | End Year | Frequency | Qty | Unit of Measure | Unit Cost | Total | Remarks |
|-----------------------|------------|------------|----------|-----------|-------|-----------------|--------------|--------------|---------|
| Base Case | | | | | | | | | |
| Agency | | | | | | | | | |
| Initial Construction | | | | | | | | | |
| Construction cost | <no event> | 5 | 5 | 1.0000 | 1.000 | LS | \$ 198,250 | \$ 198,250 | . |
| O, M, and R | | | | | | | | | |
| OM&R cost | <no event> | 5 | 80 | 1.0000 | 1.000 | LS | \$ 1,050,000 | \$ 1,050,000 | . |
| Disposal | | | | | | | | | |
| Disposal cost | <no event> | 80 | 80 | 1.0000 | 1.000 | LS | \$ 0 | \$ 0 | . |
| Alternative #2 | | | | | | | | | |
| Agency | | | | | | | | | |
| Initial Construction | | | | | | | | | |
| Construction cost | <no event> | 5 | 5 | 1.0000 | 1.000 | LS | \$ 79,300 | \$ 79,300 | . |
| O, M, and R | | | | | | | | | |
| OM&R cost | <no event> | 5 | 80 | 1.0000 | 1.000 | LS | \$ 150,000 | \$ 150,000 | . |
| Disposal | | | | | | | | | |
| Disposal cost | | 80 | 80 | 1.0000 | 1.000 | LS | \$ 0 | \$ 0 | . |
| Alternative #1 | | | | | | | | | |
| Agency | | | | | | | | | |
| Initial Construction | | | | | | | | | |
| Construction cost | <no event> | 5 | 5 | 1.0000 | 1.000 | LS | \$ 118,950 | \$ 118,950 | . |
| O, M, and R | | | | | | | | | |
| OM&R cost | <no event> | 5 | 80 | 1.0000 | 1.000 | LS | \$ 1,050,000 | \$ 1,050,000 | . |
| Disposal | | | | | | | | | |
| Disposal cost | <no event> | 80 | 80 | 1.0000 | 1.000 | LS | \$ 0 | \$ 0 | . |



Appendix F
COST of OWNERSHIP SUMMARY

Gravina TOTAL LIFE-TIME COSTS

Gravina Island Access
TOTAL LIFE-TIME COST SUMMARY
 July 2012

| | ALTERNATIVE (w/o Revenue Adjustment) | | | | | | |
|--|--------------------------------------|-----------------------|-------------------------|-------------------------|-------------------------|-------------------------|-----------------------|
| | C3-4 | F3-1 | G2 | G3 | G4 | G4v | No Action |
| Total Life-Time Cost | \$ 391,366,380 | \$ 576,449,260 | \$ 1,261,761,827 | \$ 1,194,577,579 | \$ 1,138,895,390 | \$ 982,133,753 | \$ 928,545,840 |
| Passenger Waiting Terminal, Heavy Freight Dock and Staging Area, and Ferry Layup Berth | | | \$ 67,917,639 | \$ 67,917,639 | \$ 67,917,639 | \$ 67,917,639 | |
| TOTAL: | \$ 391,366,380 | \$ 576,449,260 | \$ 1,329,679,466 | \$ 1,262,495,218 | \$ 1,206,813,029 | \$ 1,050,051,392 | \$ 928,545,840 |

| | ALTERNATIVE (w/ Revenue Adjustment) | | | | | | |
|--|-------------------------------------|-----------------------|-----------------------|-----------------------|-----------------------|-----------------------|-----------------------|
| | C3-4 | F3-1 | G2 | G3 | G4 | G4v | No Action |
| Total Life-Time Cost (Revenue Adjusted) | \$ 391,366,380 | \$ 576,449,260 | \$ 1,261,761,827 | \$ 1,194,577,579 | \$ 1,138,895,390 | \$ 982,133,753 | \$ 928,545,840 |
| Passenger Waiting Terminal, Heavy Freight Dock and Staging Area, and Ferry Layup Berth | | | \$ 67,917,639 | \$ 67,917,639 | \$ 67,917,639 | \$ 67,917,639 | |
| Bridge/Ferry Toll | -\$56,392,284 | -\$45,113,828 | -\$451,138,275 | -\$451,138,275 | -\$451,138,275 | -\$338,353,707 | -\$338,353,707 |
| TOTAL: | \$ 334,974,096 | \$ 531,335,433 | \$ 878,541,191 | \$ 811,356,942 | \$ 755,674,754 | \$ 711,697,685 | \$ 590,192,133 |

Note:

All values are for 75 year life, beginning at the completion of the construction (2020).
 Forward Inflation Rate = 2.3% (<http://www.cbo.gov/ftpdocs/123xx/doc12316/08-24-BudgetEconUpdate.pdf>, Table B-1).
 Annual tolls revenues are \$250,000 for C3-4; \$200,000 for F3-1; \$2,000,000 for G2, G3 and G4; and \$1,500,000 for the existing ferries and No Action alternatives.

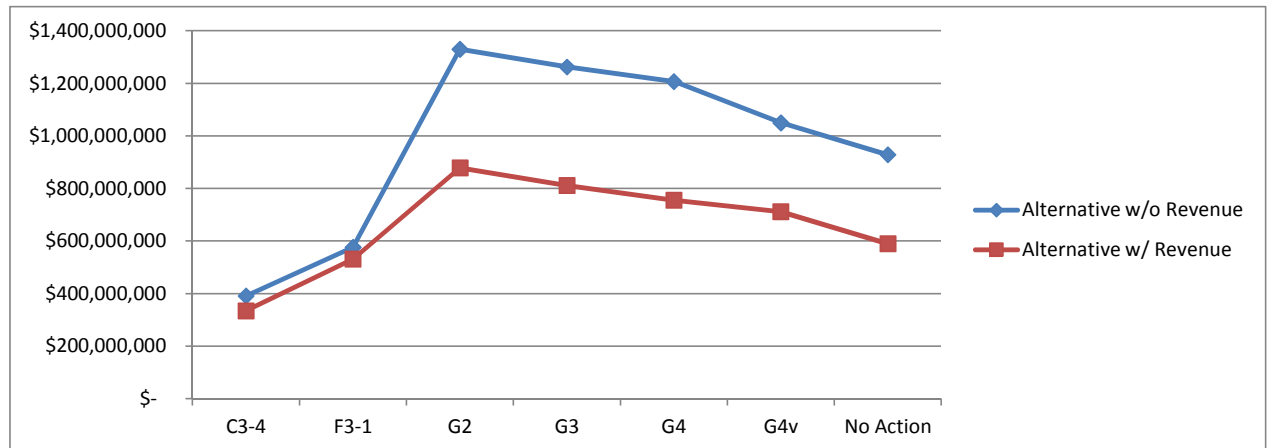

Gravina Island Access
TOTAL LIFE COST SUMMARY
 October 2011

| Bridge Alternative C3-4 | | Construction Cost | M&O Bridge | M&O Paved Road | M&O Gravel Road | Inspection Above Ground | Inspection Underwater | Guardrail Bridge | Guardrail Paved Road | Guardrail Gravel Road | Fendering System Repairs | Replace Pavement Bridge | Replace Pavement Road | Anode Replacement | Replace Joint Girand | Signs/Illumination Bridge | Signs/Illumination Paved Road | Signs/Illumination Gravel Road | Joint Assembly | Recast Transfer Span | Bridge Support/Float/Recast | Mooring Structure | Ferry Replacement | Transfer Bridge Replacement |
|-------------------------|-------------------|-------------------|--------------|----------------|-----------------|-------------------------|-----------------------|------------------|----------------------|-----------------------|--------------------------|-------------------------|-----------------------|-------------------|----------------------|---------------------------|-------------------------------|--------------------------------|----------------|----------------------|-----------------------------|-------------------|-------------------|-----------------------------|
| YEAR | Number of Periods | | | | | | | | | | | | | | | | | | | | | | | |
| Initial Cost: | | \$ 223,265,040 | \$ 4,777 | \$ 42,222 | \$ 147,610 | \$ 40,000 | \$ 40,000 | \$ 96,370 | \$ 330,642 | \$ 402,597 | \$ - | \$ 427,380 | \$ 576,504 | \$ 100,000 | \$ 500,000 | \$ 20,950 | \$ 14,130 | \$ 34,405 | \$ 1,400,000 | \$ - | \$ - | \$ - | \$ - | \$ - |
| 2015 | 1 | | | | | | | | | | | | | | | | | | | | | | | |
| 2016 | 1 | | | | | | | | | | | | | | | | | | | | | | | |
| 2017 | 2 | | | | | | | | | | | | | | | | | | | | | | | |
| 2018 | 3 | | | | | | | | | | | | | | | | | | | | | | | |
| 2019 | 4 | | | | | | | | | | | | | | | | | | | | | | | |
| 2020 | 5 | \$ 250,149,070 | \$ 5,352 | \$ 47,306 | \$ 165,385 | | | | | | | | | | | | | | | | | | | |
| 2021 | 6 | | | | | | | | | | | | | | | | | | | | | | | |
| 2022 | 7 | | | | | | | | | | | | | | | | | | | | | | | |
| 2023 | 8 | | | | | | | | | | | | | | | | | | | | | | | |
| 2024 | 9 | | | | | | | | | | | | | | | | | | | | | | | |
| 2025 | 10 | | | | | | | | | | | | | | | | | | | | | | | |
| 2026 | 11 | | | | | | | | | | | | | | | | | | | | | | | |
| 2027 | 12 | | | | | | | | | | | | | | | | | | | | | | | |
| 2028 | 13 | | | | | | | | | | | | | | | | | | | | | | | |
| 2029 | 14 | | | | | | | | | | | | | | | | | | | | | | | |
| 2030 | 15 | | | | | | | | | | | | | | | | | | | | | | | |
| 2031 | 16 | | | | | | | | | | | | | | | | | | | | | | | |
| 2032 | 17 | | | | | | | | | | | | | | | | | | | | | | | |
| 2033 | 18 | | | | | | | | | | | | | | | | | | | | | | | |
| 2034 | 19 | | | | | | | | | | | | | | | | | | | | | | | |
| 2035 | 20 | | | | | | | | | | | | | | | | | | | | | | | |
| 2036 | 21 | | | | | | | | | | | | | | | | | | | | | | | |
| 2037 | 22 | | | | | | | | | | | | | | | | | | | | | | | |
| 2038 | 23 | | | | | | | | | | | | | | | | | | | | | | | |
| 2039 | 24 | | | | | | | | | | | | | | | | | | | | | | | |
| 2040 | 25 | | | | | | | | | | | | | | | | | | | | | | | |
| 2041 | 26 | | | | | | | | | | | | | | | | | | | | | | | |
| 2042 | 27 | | | | | | | | | | | | | | | | | | | | | | | |
| 2043 | 28 | | | | | | | | | | | | | | | | | | | | | | | |
| 2044 | 29 | | | | | | | | | | | | | | | | | | | | | | | |
| 2045 | 30 | | | | | | | | | | | | | | | | | | | | | | | |
| 2046 | 31 | | | | | | | | | | | | | | | | | | | | | | | |
| 2047 | 32 | | | | | | | | | | | | | | | | | | | | | | | |
| 2048 | 33 | | | | | | | | | | | | | | | | | | | | | | | |
| 2049 | 34 | | | | | | | | | | | | | | | | | | | | | | | |
| 2050 | 35 | | | | | | | | | | | | | | | | | | | | | | | |
| 2051 | 36 | | | | | | | | | | | | | | | | | | | | | | | |
| 2052 | 37 | | | | | | | | | | | | | | | | | | | | | | | |
| 2053 | 38 | | | | | | | | | | | | | | | | | | | | | | | |
| 2054 | 39 | | | | | | | | | | | | | | | | | | | | | | | |
| 2055 | 40 | | | | | | | | | | | | | | | | | | | | | | | |
| 2056 | 41 | | | | | | | | | | | | | | | | | | | | | | | |
| 2057 | 42 | | | | | | | | | | | | | | | | | | | | | | | |
| 2058 | 43 | | | | | | | | | | | | | | | | | | | | | | | |
| 2059 | 44 | | | | | | | | | | | | | | | | | | | | | | | |
| 2060 | 45 | | | | | | | | | | | | | | | | | | | | | | | |
| 2061 | 46 | | | | | | | | | | | | | | | | | | | | | | | |
| 2062 | 47 | | | | | | | | | | | | | | | | | | | | | | | |
| 2063 | 48 | | | | | | | | | | | | | | | | | | | | | | | |
| 2064 | 49 | | | | | | | | | | | | | | | | | | | | | | | |
| 2065 | 50 | | | | | | | | | | | | | | | | | | | | | | | |
| 2066 | 51 | | | | | | | | | | | | | | | | | | | | | | | |
| 2067 | 52 | | | | | | | | | | | | | | | | | | | | | | | |
| 2068 | 53 | | | | | | | | | | | | | | | | | | | | | | | |
| 2069 | 54 | | | | | | | | | | | | | | | | | | | | | | | |
| 2070 | 55 | | | | | | | | | | | | | | | | | | | | | | | |
| 2071 | 56 | | | | | | | | | | | | | | | | | | | | | | | |
| 2072 | 57 | | | | | | | | | | | | | | | | | | | | | | | |
| 2073 | 58 | | | | | | | | | | | | | | | | | | | | | | | |
| 2074 | 59 | | | | | | | | | | | | | | | | | | | | | | | |
| 2075 | 60 | | | | | | | | | | | | | | | | | | | | | | | |
| 2076 | 61 | | | | | | | | | | | | | | | | | | | | | | | |
| 2077 | 62 | | | | | | | | | | | | | | | | | | | | | | | |
| 2078 | 63 | | | | | | | | | | | | | | | | | | | | | | | |
| 2079 | 64 | | | | | | | | | | | | | | | | | | | | | | | |
| 2080 | 65 | | | | | | | | | | | | | | | | | | | | | | | |
| 2081 | 66 | | | | | | | | | | | | | | | | | | | | | | | |
| 2082 | 67 | | | | | | | | | | | | | | | | | | | | | | | |
| 2083 | 68 | | | | | | | | | | | | | | | | | | | | | | | |
| 2084 | 69 | | | | | | | | | | | | | | | | | | | | | | | |
| 2085 | 70 | | | | | | | | | | | | | | | | | | | | | | | |
| 2086 | 71 | | | | | | | | | | | | | | | | | | | | | | | |
| 2087 | 72 | | | | | | | | | | | | | | | | | | | | | | | |
| 2088 | 73 | | | | | | | | | | | | | | | | | | | | | | | |
| 2089 | 74 | | | | | | | | | | | | | | | | | | | | | | | |
| 2090 | 75 | | | | | | | | | | | | | | | | | | | | | | | |
| 2091 | 76 | | | | | | | | | | | | | | | | | | | | | | | |
| 2092 | 77 | | | | | | | | | | | | | | | | | | | | | | | |
| 2093 | 78 | | | | | | | | | | | | | | | | | | | | | | | |
| 2094 | 79 | | | | | | | | | | | | | | | | | | | | | | | |
| 2095 | 80 | | | | | | | | | | | | | | | | | | | | | | | |
| TOTAL: | | \$ 250,149,070 | \$ 1,077,454 | \$ 9,524,021 | \$ 33,296,333 | \$ 4,415,275 | \$ 1,878,165 | \$ 4,524,970 | \$ 15,525,010 | \$ 18,903,595 | \$ - | \$ 9,210,827 | \$ 12,424,724 | | | | | | | | | | | |

Gravina Island Access
TOTAL LIFE COST SUMMARY
October 2011

Bridge Alternative F3-1

| YEAR | Number of Periods | Construction Cost | M&O Bridge | M&O Paved Road | M&O Gravel Road | Inspection Above Ground | Inspection Underwater | Guardrail Bridge | Guardrail Paved Road | Guardrail Gravel Road | Fencing System Repairs | Replace Pavement Bridge | Replace Pavement Road | Arcoes Replacement | Replace Joint Gland | Signs/Illumination Bridge | Signs/Illumination Paved Road | Signs/Illumination Gravel Road | Joint Assembly | Recoat Transfer Span | Bridge Support-Floor Recoat | Mooring Structure | Ferry Replacement | Transfer Bridge Replacement |
|---------------|-------------------|-------------------|------------|----------------|-----------------|-------------------------|-----------------------|------------------|----------------------|-----------------------|------------------------|-------------------------|-----------------------|--------------------|---------------------|---------------------------|-------------------------------|--------------------------------|----------------|----------------------|-----------------------------|-------------------|-------------------|-----------------------------|
| Initial Cost: | \$ | 275,966,131 | \$ 5,079 | \$ 132,874 | \$ 49,807 | \$ 80,000 | \$ 80,000 | \$ 102,465 | \$ 1,551,303 | \$ 135,837 | \$ - | \$ 454,410 | \$ 2,704,836 | \$ 200,000 | \$ 1,000,000 | \$ 22,275 | \$ 66,295 | \$ 11,610 | \$ 2,800,000 | \$ - | \$ - | \$ - | \$ - | \$ - |
| 2015 | 1 | | | | | | | | | | | | | | | | | | | | | | | |
| 2016 | 2 | | | | | | | | | | | | | | | | | | | | | | | |
| 2017 | 3 | | | | | | | | | | | | | | | | | | | | | | | |
| 2018 | 4 | | | | | | | | | | | | | | | | | | | | | | | |
| 2019 | 5 | \$ 309,196,062 | \$ 5,690 | \$ 148,874 | \$ 55,804 | | | | | | | | | | | | | | | | | | | |
| 2020 | 6 | | 5,821 | 152,288 | 57,088 | | | | | | | | | | | | | | | | | | | |
| 2021 | 7 | | 5,955 | 155,801 | 58,401 | \$ 93,804 | | | | | | | | | | | | | | | | | | |
| 2022 | 8 | | 6,092 | 159,384 | 59,744 | | | | | | | | | | | | | | | | | | | |
| 2023 | 9 | | 6,232 | 163,050 | 61,118 | 98,168 | | | | | | | | | | | | | | | | | | |
| 2024 | 10 | | 6,375 | 166,800 | 62,524 | \$ 100,426 | \$ 128,627 | \$ 1,947,390 | \$ 170,520 | \$ - | | | | | | | | | | | | | | |
| 2025 | 11 | | 6,522 | 170,837 | 63,982 | 102,736 | | | | | | | | | | | | | | | | | | |
| 2026 | 12 | | 6,672 | 174,561 | 65,433 | | | | | | | | | | | | | | | | | | | |
| 2027 | 13 | | 6,826 | 178,576 | 66,938 | 107,516 | | | | | | | | | | | | | | | | | | |
| 2028 | 14 | | 6,983 | 182,684 | 68,478 | | | | | | | | | | | | | | | | | | | |
| 2029 | 15 | | 7,143 | 186,885 | 70,053 | 112,519 | 112,519 | 144,115 | 2,181,881 | 191,052 | \$ - | \$ 639,120 | \$ 3,804,306 | \$ 281,297 | \$ 1,406,483 | | | | | | | | | \$ - |
| 2030 | 16 | | 7,307 | 191,184 | 71,664 | | | | | | | | | | | | | | | | | | | |
| 2031 | 17 | | 7,475 | 195,581 | 73,312 | 117,754 | | | | | | | | | | | | | | | | | | |
| 2032 | 18 | | 7,647 | 200,079 | 74,998 | | | | | | | | | | | | | | | | | | | |
| 2033 | 19 | | 7,823 | 204,681 | 76,723 | 123,233 | | | | | | | | | | | | | | | | | | |
| 2034 | 20 | | 8,003 | 209,389 | 78,488 | | 126,067 | 161,469 | 2,444,608 | 214,058 | | | | | | | | | | | | | | |
| 2035 | 21 | | 8,187 | 214,205 | 80,293 | 128,967 | | | | | | | | | | \$ 35,102 | \$ 104,470 | \$ 18,296 | | \$ - | \$ - | | | |
| 2036 | 22 | | 8,376 | 219,131 | 82,140 | | | | | | | | | | | | | | | | | | | |
| 2037 | 23 | | 8,568 | 224,171 | 84,029 | 134,968 | | | | | | | | | | | | | | | | | | |
| 2038 | 24 | | 8,765 | 229,327 | 85,962 | | | | | | | | | | | | | | | | | | | |
| 2039 | 25 | | 8,967 | 234,602 | 87,939 | 141,248 | 141,248 | 180,912 | 2,738,971 | 239,833 | | 802,304 | 4,775,642 | 353,119 | 1,765,594 | | | | | | | | | |
| 2040 | 26 | | 9,173 | 239,998 | 89,961 | | | | | | | | | | | | | | | | | | | |
| 2041 | 27 | | 9,384 | 245,518 | 92,030 | 147,820 | | | | | | | | | | | | | | | | | | |
| 2042 | 28 | | 9,600 | 251,165 | 94,147 | | | | | | | | | | | | | | | | | | | |
| 2043 | 29 | | 9,821 | 256,941 | 96,313 | 154,698 | | | | | | | | | | | | | | | | | | |
| 2044 | 30 | | 10,047 | 262,851 | 98,528 | | 158,256 | 202,696 | 3,068,779 | 268,712 | | | | | | | | | \$ 5,538,945 | | | | | |
| 2045 | 31 | | 10,278 | 268,897 | 100,794 | 161,895 | | | | | | | | | | | | | | | | | | |
| 2046 | 32 | | 10,514 | 275,081 | 103,112 | | | | | | | | | | | | | | | | | | | |
| 2047 | 33 | | 10,756 | 281,408 | 105,484 | 169,428 | | | | | | | | | | | | | | | | | | |
| 2048 | 34 | | 11,003 | 287,880 | 107,910 | | | | | | | | | | | | | | | | | | | |
| 2049 | 35 | | 11,256 | 294,502 | 110,392 | 177,312 | 177,312 | 227,103 | 3,438,300 | 301,068 | | 1,007,152 | 5,994,985 | 443,279 | 2,216,395 | 49,370 | 146,936 | 25,732 | | | | | | |
| 2050 | 36 | | 11,515 | 301,275 | 112,931 | | | | | | | | | | | | | | | | | | | |
| 2051 | 37 | | 11,780 | 308,205 | 115,528 | 185,562 | | | | | | | | | | | | | | | | | | |
| 2052 | 38 | | 12,051 | 315,293 | 118,185 | | | | | | | | | | | | | | | | | | | |
| 2053 | 39 | | 12,328 | 322,545 | 120,904 | 194,196 | | | | | | | | | | | | | | | | | | |
| 2054 | 40 | | 12,612 | 329,964 | 123,684 | | 198,662 | 254,449 | 3,852,317 | 337,321 | | | | | | | | | | | | | | |
| 2055 | 41 | | 12,902 | 337,553 | 126,529 | 203,231 | | | | | | | | | | | | | | | | | | |
| 2056 | 42 | | 13,199 | 345,316 | 129,439 | | | | | | | | | | | | | | | | | | | |
| 2057 | 43 | | 13,502 | 353,259 | 132,416 | 212,688 | | | | | | | | | | | | | | | | | | |
| 2058 | 44 | | 13,813 | 361,384 | 135,462 | | | | | | | | | | | | | | | | | | | |
| 2059 | 45 | | 14,130 | 369,695 | 138,578 | 222,584 | 222,584 | 285,088 | 4,316,186 | 377,939 | | 1,264,304 | 7,525,658 | 556,459 | 2,782,297 | | | | | | | | | |
| 2060 | 46 | | 14,455 | 378,198 | 141,765 | | | | | | | | | | | | | | | | | | | |
| 2061 | 47 | | 14,788 | 386,897 | 145,025 | 232,940 | | | | | | | | | | | | | | | | | | |
| 2062 | 48 | | 15,128 | 395,796 | 148,361 | | | | | | | | | | | | | | | | | | | |
| 2063 | 49 | | 15,476 | 404,899 | 151,773 | 243,779 | | | | | | | | | | | | | | | | | | |
| 2064 | 50 | | 15,832 | 414,212 | 155,264 | | 249,386 | 319,416 | 4,835,911 | 423,448 | | | | | | | | | | | | | | |
| 2065 | 51 | | 16,196 | 423,738 | 158,836 | 255,122 | | | | | | | | | | | | | | | | | | |
| 2066 | 52 | | 16,569 | 433,484 | 162,498 | | | | | | | | | | | | | | | | | | | |
| 2067 | 53 | | 16,950 | 443,455 | 166,226 | 266,992 | | | | | | | | | | | | | | | | | | |
| 2068 | 54 | | 17,340 | 453,654 | 170,049 | | | | | | | | | | | | | | | | | | | |
| 2069 | 55 | | 17,738 | 464,088 | 173,960 | 279,415 | | | | | | | | | | | | | | | | | | |
| 2070 | 56 | | 18,146 | 474,762 | 177,951 | | 279,415 | 357,878 | 5,418,218 | 474,436 | | 1,587,113 | 9,447,150 | 698,538 | 3,492,688 | | | | | | | | | |
| 2071 | 57 | | 18,564 | 485,682 | 182,054 | 292,416 | | | | | | | | | | | | | | | | | | |
| 2072 | 58 | | 18,991 | 496,852 | 186,241 | | | | | | | | | | | | | | | | | | | |
| 2073 | 59 | | 19,427 | 508,280 | 190,525 | 306,022 | | | | | | | | | | | | | | | | | | |
| 2074 | 60 | | 19,874 | 519,970 | 194,907 | | 313,060 | 400,972 | 6,070,642 | 531,565 | | | | | | | | | | | | | | |
| 2075 | 61 | | 20,331 | 531,930 | 199,390 | 320,261 | | | | | | | | | | | | | | | | | | |
| 2076 | 62 | | 20,799 | 544,164 | 203,976 | | | | | | | | | | | | | | | | | | | |
| 2077 | 63 | | 21,277 | 556,680 | 208,667 | 335,162 | | | | | | | | | | | | | | | | | | |
| 2078 | 64 | | 21,767 | 569,483 | 213,467 | | | | | | | | | | | | | | | | | | | |
| 2079 | 65 | | 22,267 | 582,582 | 218,376 | 350,757 | 350,757 | 449,254 | 6,801,627 | 595,572 | | 1,992,343 | 11,859,247 | 876,892 | 4,384,461 | 97,664 | 290,668 | 50,904 | | | | | | |
| 2080 | 66 | | 22,780 | 595,981 | 223,399 | | | | | | | | | | | | | | | | | | | |
| 2081 | 67 | | 23,303 | 609,689 | 228,537 | 367,077 | | | | | | | | | | | | | | | | | | |

Gravina Island Access
TOTAL LIFE COST SUMMARY
 October 2011

Ferry Alternative G3

| YEAR | Number of Periods | Construction Cost | M&O Ferry and Dock | M&O Paved Road | M&O Gravel Road | Inspection Above Ground | Inspection Underwater | Guardrail Bridge | Guardrail Paved Road | Guardrail Gravel Road | Fendering System Repairs | Replace Pavement Bridge | Replace Pavement Road | Acrode Replacement | Replace Joint Gland | Signs/Illumination Bridge | Signs/Illumination Paved Road | Signs/Illumination Gravel Road | Joint Assembly | Recast Transfer Span | Bridge Support/Floor Recast | Moorng Structure | Ferry Replacement | Transfer Bridge Replacement |
|---------------|-------------------|-------------------------|--------------------|----------------|-----------------|-------------------------|-----------------------|------------------|----------------------|-----------------------|--------------------------|-------------------------|-----------------------|--------------------|---------------------|---------------------------|-------------------------------|--------------------------------|----------------|----------------------|-----------------------------|------------------|-------------------|-----------------------------|
| Initial Cost: | | \$ 70,046,235 | \$ 3,200,000 | \$ 43,672 | \$ 109,627 | \$ 160,000 | \$ 100,000 | \$ - | \$ 595,530 | \$ 298,935 | \$ 200,000 | \$ - | \$ 1,038,360 | \$ 80,000 | \$ - | \$ - | \$ 25,450 | \$ 25,555 | \$ - | \$ 600,000 | \$ 300,000 | \$ 6,000,000 | \$ 24,000,000 | \$ 4,000,000 |
| 2015 | 1 | | | | | | | | | | | | | | | | | | | | | | | |
| 2016 | 2 | | | | | | | | | | | | | | | | | | | | | | | |
| 2017 | 3 | | | | | | | | | | | | | | | | | | | | | | | |
| 2018 | 4 | | | | | | | | | | | | | | | | | | | | | | | |
| 2019 | 5 | \$ 78,480,718 | \$ 3,585,322 | \$ 48,931 | \$ 122,827 | | | | | | | | | | | | | | | | | | | |
| 2020 | 6 | | | | | | | | | | | | | | | | | | | | | | | |
| 2021 | 7 | | | | | | | | | | | | | | | | | | | | | | | |
| 2022 | 8 | | | | | | | | | | | | | | | | | | | | | | | |
| 2023 | 9 | | | | | | | | | | | | | | | | | | | | | | | |
| 2024 | 10 | | | | | | | | | | | | | | | | | | | | | | | |
| 2025 | 11 | | | | | | | | | | | | | | | | | | | | | | | |
| 2026 | 12 | | | | | | | | | | | | | | | | | | | | | | | |
| 2027 | 13 | | | | | | | | | | | | | | | | | | | | | | | |
| 2028 | 14 | | | | | | | | | | | | | | | | | | | | | | | |
| 2029 | 15 | | | | | | | | | | | | | | | | | | | | | | | |
| 2030 | 16 | | | | | | | | | | | | | | | | | | | | | | | |
| 2031 | 17 | | | | | | | | | | | | | | | | | | | | | | | |
| 2032 | 18 | | | | | | | | | | | | | | | | | | | | | | | |
| 2033 | 19 | | | | | | | | | | | | | | | | | | | | | | | |
| 2034 | 20 | | | | | | | | | | | | | | | | | | | | | | | |
| 2035 | 21 | | | | | | | | | | | | | | | | | | | | | | | |
| 2036 | 22 | | | | | | | | | | | | | | | | | | | | | | | |
| 2037 | 23 | | | | | | | | | | | | | | | | | | | | | | | |
| 2038 | 24 | | | | | | | | | | | | | | | | | | | | | | | |
| 2039 | 25 | | | | | | | | | | | | | | | | | | | | | | | |
| 2040 | 26 | | | | | | | | | | | | | | | | | | | | | | | |
| 2041 | 27 | | | | | | | | | | | | | | | | | | | | | | | |
| 2042 | 28 | | | | | | | | | | | | | | | | | | | | | | | |
| 2043 | 29 | | | | | | | | | | | | | | | | | | | | | | | |
| 2044 | 30 | | | | | | | | | | | | | | | | | | | | | | | |
| 2045 | 31 | | | | | | | | | | | | | | | | | | | | | | | |
| 2046 | 32 | | | | | | | | | | | | | | | | | | | | | | | |
| 2047 | 33 | | | | | | | | | | | | | | | | | | | | | | | |
| 2048 | 34 | | | | | | | | | | | | | | | | | | | | | | | |
| 2049 | 35 | | | | | | | | | | | | | | | | | | | | | | | |
| 2050 | 36 | | | | | | | | | | | | | | | | | | | | | | | |
| 2051 | 37 | | | | | | | | | | | | | | | | | | | | | | | |
| 2052 | 38 | | | | | | | | | | | | | | | | | | | | | | | |
| 2053 | 39 | | | | | | | | | | | | | | | | | | | | | | | |
| 2054 | 40 | | | | | | | | | | | | | | | | | | | | | | | |
| 2055 | 41 | | | | | | | | | | | | | | | | | | | | | | | |
| 2056 | 42 | | | | | | | | | | | | | | | | | | | | | | | |
| 2057 | 43 | | | | | | | | | | | | | | | | | | | | | | | |
| 2058 | 44 | | | | | | | | | | | | | | | | | | | | | | | |
| 2059 | 45 | | | | | | | | | | | | | | | | | | | | | | | |
| 2060 | 46 | | | | | | | | | | | | | | | | | | | | | | | |
| 2061 | 47 | | | | | | | | | | | | | | | | | | | | | | | |
| 2062 | 48 | | | | | | | | | | | | | | | | | | | | | | | |
| 2063 | 49 | | | | | | | | | | | | | | | | | | | | | | | |
| 2064 | 50 | | | | | | | | | | | | | | | | | | | | | | | |
| 2065 | 51 | | | | | | | | | | | | | | | | | | | | | | | |
| 2066 | 52 | | | | | | | | | | | | | | | | | | | | | | | |
| 2067 | 53 | | | | | | | | | | | | | | | | | | | | | | | |
| 2068 | 54 | | | | | | | | | | | | | | | | | | | | | | | |
| 2069 | 55 | | | | | | | | | | | | | | | | | | | | | | | |
| 2070 | 56 | | | | | | | | | | | | | | | | | | | | | | | |
| 2071 | 57 | | | | | | | | | | | | | | | | | | | | | | | |
| 2072 | 58 | | | | | | | | | | | | | | | | | | | | | | | |
| 2073 | 59 | | | | | | | | | | | | | | | | | | | | | | | |
| 2074 | 60 | | | | | | | | | | | | | | | | | | | | | | | |
| 2075 | 61 | | | | | | | | | | | | | | | | | | | | | | | |
| 2076 | 62 | | | | | | | | | | | | | | | | | | | | | | | |
| 2077 | 63 | | | | | | | | | | | | | | | | | | | | | | | |
| 2078 | 64 | | | | | | | | | | | | | | | | | | | | | | | |
| 2079 | 65 | | | | | | | | | | | | | | | | | | | | | | | |
| 2080 | 66 | | | | | | | | | | | | | | | | | | | | | | | |
| 2081 | 67 | | | | | | | | | | | | | | | | | | | | | | | |
| 2082 | 68 | | | | | | | | | | | | | | | | | | | | | | | |
| 2083 | 69 | | | | | | | | | | | | | | | | | | | | | | | |
| 2084 | 70 | | | | | | | | | | | | | | | | | | | | | | | |
| 2085 | 71 | | | | | | | | | | | | | | | | | | | | | | | |
| 2086 | 72 | | | | | | | | | | | | | | | | | | | | | | | |
| 2087 | 73 | | | | | | | | | | | | | | | | | | | | | | | |
| 2088 | 74 | | | | | | | | | | | | | | | | | | | | | | | |
| 2089 | 75 | | | | | | | | | | | | | | | | | | | | | | | |
| 2090 | 76 | | | | | | | | | | | | | | | | | | | | | | | |
| 2091 | 77 | | | | | | | | | | | | | | | | | | | | | | | |
| 2092 | 78 | | | | | | | | | | | | | | | | | | | | | | | |
| 2093 | 79 | | | | | | | | | | | | | | | | | | | | | | | |
| 2094 | 80 | | | | | | | | | | | | | | | | | | | | | | | |
| 2095 | 80 | | | | | | | | | | | | | | | | | | | | | | | |
| TOTAL: | | \$ 78,480,718 | \$ 721,821,241 | \$ 9,851,100 | \$ 24,728,391 | \$ 17,661,101 | \$ 4,695,414 | \$ - | \$ 27,962,597 | \$ 14,036,235 | \$ 9,390,827 | \$ - | \$ 22,378,573 | \$ 1,724,148 | \$ - | \$ - | \$ 444,375 | \$ 446,208 | \$ - | \$ 10,476,414 | \$ 5,238,207 | \$ 47,923,220 | \$ 191,692,879 | \$ 5,625,932 |
| TOTAL: | | \$ 1,194,577,579 | | | | | | | | | | | | | | | | | | | | | | |

Gravina Island Access
TOTAL LIFE COST SUMMARY
October 2011

Ferry Alternative G4v

| YEAR | Number of Periods | Construction Cost | M&O Ferry and Dock | M&O Paved Road | M&O Gravel Road | Inspection Above Ground | Inspection Underwater | Guardrail Bridge | Guardrail Paved Road | Guardrail Gravel Road | Fendering System Repairs | Replace Pavement Bridge | Replace Pavement Road | Anode Replacement | Replace Joint Gland | Sign/Illumination Bridge | Sign/Illumination Paved Road | Sign/Illumination Gravel Road | Joint Assembly | Recast Transfer Span | Bridge Support/Float Recast | Mooring Structure | Ferry Replacement | Transfer Bridge Replacement |
|---------------|-------------------|-------------------|--------------------|----------------|-----------------|-------------------------|-----------------------|------------------|----------------------|-----------------------|--------------------------|-------------------------|-----------------------|-------------------|---------------------|--------------------------|------------------------------|-------------------------------|----------------|----------------------|-----------------------------|-------------------|-------------------|-----------------------------|
| Initial Cost: | | \$ 22,791,516 | \$ 3,200,000 | \$ - | \$ 147,610 | \$ 80,000 | \$ 50,000 | \$ - | \$ - | \$ 402,597 | \$ 100,000 | \$ - | \$ - | \$ 40,000 | \$ - | \$ - | \$ - | \$ 34,410 | \$ - | \$ 300,000 | \$ 150,000 | \$ 3,000,000 | \$ 16,000,000 | \$ 4,000,000 |
| 2015 | | | | | | | | | | | | | | | | | | | | | | | | |
| 2016 | 1 | | | | | | | | | | | | | | | | | | | | | | | |
| 2017 | 2 | | | | | | | | | | | | | | | | | | | | | | | |
| 2018 | 3 | | | | | | | | | | | | | | | | | | | | | | | |
| 2019 | 4 | | | | | | | | | | | | | | | | | | | | | | | |
| 2020 | 5 | \$ 25,535,913 | \$ 3,585,322 | \$ - | \$ 165,385 | | | | | | | | | | | | | | | | | | | |
| 2021 | 6 | | | | | | | | | | | | | | | | | | | | | | | |
| 2022 | 7 | | | | | | | | | | | | | | | | | | | | | | | |
| 2023 | 8 | | | | | | | | | | | | | | | | | | | | | | | |
| 2024 | 9 | | | | | | | | | | | | | | | | | | | | | | | |
| 2025 | 10 | | | | | | | | | | | | | | | | | | | | | | | |
| 2026 | 11 | | | | | | | | | | | | | | | | | | | | | | | |
| 2027 | 12 | | | | | | | | | | | | | | | | | | | | | | | |
| 2028 | 13 | | | | | | | | | | | | | | | | | | | | | | | |
| 2029 | 14 | | | | | | | | | | | | | | | | | | | | | | | |
| 2030 | 15 | | | | | | | | | | | | | | | | | | | | | | | |
| 2031 | 16 | | | | | | | | | | | | | | | | | | | | | | | |
| 2032 | 17 | | | | | | | | | | | | | | | | | | | | | | | |
| 2033 | 18 | | | | | | | | | | | | | | | | | | | | | | | |
| 2034 | 19 | | | | | | | | | | | | | | | | | | | | | | | |
| 2035 | 20 | | | | | | | | | | | | | | | | | | | | | | | |
| 2036 | 21 | | | | | | | | | | | | | | | | | | | | | | | |
| 2037 | 22 | | | | | | | | | | | | | | | | | | | | | | | |
| 2038 | 23 | | | | | | | | | | | | | | | | | | | | | | | |
| 2039 | 24 | | | | | | | | | | | | | | | | | | | | | | | |
| 2040 | 25 | | | | | | | | | | | | | | | | | | | | | | | |
| 2041 | 26 | | | | | | | | | | | | | | | | | | | | | | | |
| 2042 | 27 | | | | | | | | | | | | | | | | | | | | | | | |
| 2043 | 28 | | | | | | | | | | | | | | | | | | | | | | | |
| 2044 | 29 | | | | | | | | | | | | | | | | | | | | | | | |
| 2045 | 30 | | | | | | | | | | | | | | | | | | | | | | | |
| 2046 | 31 | | | | | | | | | | | | | | | | | | | | | | | |
| 2047 | 32 | | | | | | | | | | | | | | | | | | | | | | | |
| 2048 | 33 | | | | | | | | | | | | | | | | | | | | | | | |
| 2049 | 34 | | | | | | | | | | | | | | | | | | | | | | | |
| 2050 | 35 | | | | | | | | | | | | | | | | | | | | | | | |
| 2051 | 36 | | | | | | | | | | | | | | | | | | | | | | | |
| 2052 | 37 | | | | | | | | | | | | | | | | | | | | | | | |
| 2053 | 38 | | | | | | | | | | | | | | | | | | | | | | | |
| 2054 | 39 | | | | | | | | | | | | | | | | | | | | | | | |
| 2055 | 40 | | | | | | | | | | | | | | | | | | | | | | | |
| 2056 | 41 | | | | | | | | | | | | | | | | | | | | | | | |
| 2057 | 42 | | | | | | | | | | | | | | | | | | | | | | | |
| 2058 | 43 | | | | | | | | | | | | | | | | | | | | | | | |
| 2059 | 44 | | | | | | | | | | | | | | | | | | | | | | | |
| 2060 | 45 | | | | | | | | | | | | | | | | | | | | | | | |
| 2061 | 46 | | | | | | | | | | | | | | | | | | | | | | | |
| 2062 | 47 | | | | | | | | | | | | | | | | | | | | | | | |
| 2063 | 48 | | | | | | | | | | | | | | | | | | | | | | | |
| 2064 | 49 | | | | | | | | | | | | | | | | | | | | | | | |
| 2065 | 50 | | | | | | | | | | | | | | | | | | | | | | | |
| 2066 | 51 | | | | | | | | | | | | | | | | | | | | | | | |
| 2067 | 52 | | | | | | | | | | | | | | | | | | | | | | | |
| 2068 | 53 | | | | | | | | | | | | | | | | | | | | | | | |
| 2069 | 54 | | | | | | | | | | | | | | | | | | | | | | | |
| 2070 | 55 | | | | | | | | | | | | | | | | | | | | | | | |
| 2071 | 56 | | | | | | | | | | | | | | | | | | | | | | | |
| 2072 | 57 | | | | | | | | | | | | | | | | | | | | | | | |
| 2073 | 58 | | | | | | | | | | | | | | | | | | | | | | | |
| 2074 | 59 | | | | | | | | | | | | | | | | | | | | | | | |
| 2075 | 60 | | | | | | | | | | | | | | | | | | | | | | | |
| 2076 | 61 | | | | | | | | | | | | | | | | | | | | | | | |
| 2077 | 62 | | | | | | | | | | | | | | | | | | | | | | | |
| 2078 | 63 | | | | | | | | | | | | | | | | | | | | | | | |
| 2079 | 64 | | | | | | | | | | | | | | | | | | | | | | | |
| 2080 | 65 | | | | | | | | | | | | | | | | | | | | | | | |
| 2081 | 66 | | | | | | | | | | | | | | | | | | | | | | | |
| 2082 | 67 | | | | | | | | | | | | | | | | | | | | | | | |
| 2083 | 68 | | | | | | | | | | | | | | | | | | | | | | | |
| 2084 | 69 | | | | | | | | | | | | | | | | | | | | | | | |
| 2085 | 70 | | | | | | | | | | | | | | | | | | | | | | | |
| 2086 | 71 | | | | | | | | | | | | | | | | | | | | | | | |
| 2087 | 72 | | | | | | | | | | | | | | | | | | | | | | | |
| 2088 | 73 | | | | | | | | | | | | | | | | | | | | | | | |
| 2089 | 74 | | | | | | | | | | | | | | | | | | | | | | | |
| 2090 | 75 | | | | | | | | | | | | | | | | | | | | | | | |
| 2091 | 76 | | | | | | | | | | | | | | | | | | | | | | | |
| 2092 | 77 | | | | | | | | | | | | | | | | | | | | | | | |
| 2093 | 78 | | | | | | | | | | | | | | | | | | | | | | | |
| 2094 | 79 | | | | | | | | | | | | | | | | | | | | | | | |
| 2095 | 80 | | | | | | | | | | | | | | | | | | | | | | | |
| TOTAL: | | \$ 25,535,913 | \$ 721,821,241 | \$ - | \$ 33,296,333 | \$ 8,830,550 | \$ 2,347,707 | \$ - | \$ - | \$ 18,903,595 | \$ 4,695,414 | \$ - | \$ - | \$ 862,074 | \$ - | \$ - | \$ - | \$ 600,822 | \$ - | \$ 5,238,207 | \$ 2,619,103 | \$ 23,961,610 | \$ 127,795,253 | \$ 5,625,932 |
| | | | | | | | | | | | | | | | | | | | | | | | | |

Gravina Island Access
TOTAL LIFE COST SUMMARY
 October 2011

Passenger Waiting Terminal, Heavy Freight Dock and Staging Area, and Ferry Layup Berth

| YEAR | Number of Periods | Waiting Area Construction Cost | Freight Dock Construction Cost | Layup Berth Construction Cost | M&O Freight Dock | M&O Paved Road | M&O Gravel Road | Inspection Above Ground | Inspection Underwater | Guardrail Bridge | Guardrail Paved Road | Guardrail Gravel Road | Fendering System Repairs | Replace Pavement Bridge | Replace Dock Surfacing | Anode Replacement | Replace Joint Gland | Signs/Illumination Bridge | Signs/Illumination Paved Road | Signs/Illumination Gravel Road | Joint Assembly | Recast Transfer Span | Bridge Support-Float Recast | Moorng Structure | Ferry Replacement | Transfer Bridge Replacement | |
|---------------|-------------------|--------------------------------|--------------------------------|-------------------------------|------------------|----------------|-----------------|-------------------------|-----------------------|------------------|----------------------|-----------------------|--------------------------|-------------------------|------------------------|-------------------|---------------------|---------------------------|-------------------------------|--------------------------------|----------------|----------------------|-----------------------------|------------------|-------------------|-----------------------------|--------------|
| | | Initial Cost: | \$ 1,403,387 | \$ 5,426,431 | \$ 5,987,786 | \$ 10,000 | \$ - | \$ - | \$ 40,000 | \$ 40,000 | \$ - | \$ - | \$ - | \$ - | \$ 50,000 | \$ - | \$ 400,000 | \$ 100,000 | \$ - | \$ - | \$ - | \$ - | \$ 150,000 | \$ 75,000 | \$ 1,500,000 | \$ - | \$ 2,000,000 |
| 2015 | | | | | | | | | | | | | | | | | | | | | | | | | | | |
| 2016 | 1 | | | | | | | | | | | | | | | | | | | | | | | | | | |
| 2017 | 2 | | | | | | | | | | | | | | | | | | | | | | | | | | |
| 2018 | 3 | | | | | | | | | | | | | | | | | | | | | | | | | | |
| 2019 | 4 | | | | | | | | | | | | | | | | | | | | | | | | | | |
| 2020 | 5 | \$ | 1,572,373 | \$ 6,079,844 | \$ 6,708,794 | \$ 11,204 | \$ - | \$ - | | | | | | | | | | | | | | | | | | | |
| 2021 | 6 | | | | | | | | | | | | | | | | | | | | | | | | | | |
| 2022 | 7 | | | | | | | | | | | | | | | | | | | | | | | | | | |
| 2023 | 8 | | | | | | | | | | | | | | | | | | | | | | | | | | |
| 2024 | 9 | | | | | | | | | | | | | | | | | | | | | | | | | | |
| 2025 | 10 | | | | | | | | | | | | | | | | | | | | | | | | | | |
| 2026 | 11 | | | | | | | | | | | | | | | | | | | | | | | | | | |
| 2027 | 12 | | | | | | | | | | | | | | | | | | | | | | | | | | |
| 2028 | 13 | | | | | | | | | | | | | | | | | | | | | | | | | | |
| 2029 | 14 | | | | | | | | | | | | | | | | | | | | | | | | | | |
| 2030 | 15 | | | | | | | | | | | | | | | | | | | | | | | | | | |
| 2031 | 16 | | | | | | | | | | | | | | | | | | | | | | | | | | |
| 2032 | 17 | | | | | | | | | | | | | | | | | | | | | | | | | | |
| 2033 | 18 | | | | | | | | | | | | | | | | | | | | | | | | | | |
| 2034 | 19 | | | | | | | | | | | | | | | | | | | | | | | | | | |
| 2035 | 20 | | | | | | | | | | | | | | | | | | | | | | | | | | |
| 2036 | 21 | | | | | | | | | | | | | | | | | | | | | | | | | | |
| 2037 | 22 | | | | | | | | | | | | | | | | | | | | | | | | | | |
| 2038 | 23 | | | | | | | | | | | | | | | | | | | | | | | | | | |
| 2039 | 24 | | | | | | | | | | | | | | | | | | | | | | | | | | |
| 2040 | 25 | | | | | | | | | | | | | | | | | | | | | | | | | | |
| 2041 | 26 | | | | | | | | | | | | | | | | | | | | | | | | | | |
| 2042 | 27 | | | | | | | | | | | | | | | | | | | | | | | | | | |
| 2043 | 28 | | | | | | | | | | | | | | | | | | | | | | | | | | |
| 2044 | 29 | | | | | | | | | | | | | | | | | | | | | | | | | | |
| 2045 | 30 | | | | | | | | | | | | | | | | | | | | | | | | | | |
| 2046 | 31 | | | | | | | | | | | | | | | | | | | | | | | | | | |
| 2047 | 32 | | | | | | | | | | | | | | | | | | | | | | | | | | |
| 2048 | 33 | | | | | | | | | | | | | | | | | | | | | | | | | | |
| 2049 | 34 | | | | | | | | | | | | | | | | | | | | | | | | | | |
| 2050 | 35 | | | | | | | | | | | | | | | | | | | | | | | | | | |
| 2051 | 36 | | | | | | | | | | | | | | | | | | | | | | | | | | |
| 2052 | 37 | | | | | | | | | | | | | | | | | | | | | | | | | | |
| 2053 | 38 | | | | | | | | | | | | | | | | | | | | | | | | | | |
| 2054 | 39 | | | | | | | | | | | | | | | | | | | | | | | | | | |
| 2055 | 40 | | | | | | | | | | | | | | | | | | | | | | | | | | |
| 2056 | 41 | | | | | | | | | | | | | | | | | | | | | | | | | | |
| 2057 | 42 | | | | | | | | | | | | | | | | | | | | | | | | | | |
| 2058 | 43 | | | | | | | | | | | | | | | | | | | | | | | | | | |
| 2059 | 44 | | | | | | | | | | | | | | | | | | | | | | | | | | |
| 2060 | 45 | | | | | | | | | | | | | | | | | | | | | | | | | | |
| 2061 | 46 | | | | | | | | | | | | | | | | | | | | | | | | | | |
| 2062 | 47 | | | | | | | | | | | | | | | | | | | | | | | | | | |
| 2063 | 48 | | | | | | | | | | | | | | | | | | | | | | | | | | |
| 2064 | 49 | | | | | | | | | | | | | | | | | | | | | | | | | | |
| 2065 | 50 | | | | | | | | | | | | | | | | | | | | | | | | | | |
| 2066 | 51 | | | | | | | | | | | | | | | | | | | | | | | | | | |
| 2067 | 52 | | | | | | | | | | | | | | | | | | | | | | | | | | |
| 2068 | 53 | | | | | | | | | | | | | | | | | | | | | | | | | | |
| 2069 | 54 | | | | | | | | | | | | | | | | | | | | | | | | | | |
| 2070 | 55 | | | | | | | | | | | | | | | | | | | | | | | | | | |
| 2071 | 56 | | | | | | | | | | | | | | | | | | | | | | | | | | |
| 2072 | 57 | | | | | | | | | | | | | | | | | | | | | | | | | | |
| 2073 | 58 | | | | | | | | | | | | | | | | | | | | | | | | | | |
| 2074 | 59 | | | | | | | | | | | | | | | | | | | | | | | | | | |
| 2075 | 60 | | | | | | | | | | | | | | | | | | | | | | | | | | |
| 2076 | 61 | | | | | | | | | | | | | | | | | | | | | | | | | | |
| 2077 | 62 | | | | | | | | | | | | | | | | | | | | | | | | | | |
| 2078 | 63 | | | | | | | | | | | | | | | | | | | | | | | | | | |
| 2079 | 64 | | | | | | | | | | | | | | | | | | | | | | | | | | |
| 2080 | 65 | | | | | | | | | | | | | | | | | | | | | | | | | | |
| 2081 | 66 | | | | | | | | | | | | | | | | | | | | | | | | | | |
| 2082 | 67 | | | | | | | | | | | | | | | | | | | | | | | | | | |
| 2083 | 68 | | | | | | | | | | | | | | | | | | | | | | | | | | |
| 2084 | 69 | | | | | | | | | | | | | | | | | | | | | | | | | | |
| 2085 | 70 | | | | | | | | | | | | | | | | | | | | | | | | | | |
| 2086 | 71 | | | | | | | | | | | | | | | | | | | | | | | | | | |
| 2087 | 72 | | | | | | | | | | | | | | | | | | | | | | | | | | |
| 2088 | 73 | | | | | | | | | | | | | | | | | | | | | | | | | | |
| 2089 | 74 | | | | | | | | | | | | | | | | | | | | | | | | | | |
| 2090 | 75 | | | | | | | | | | | | | | | | | | | | | | | | | | |
| 2091 | 76 | | | | | | | | | | | | | | | | | | | | | | | | | | |
| 2092 | 77 | | | | | | | | | | | | | | | | | | | | | | | | | | |
| 2093 | 78 | | | | | | | | | | | | | | | | | | | | | | | | | | |
| 2094 | 79 | | | | | | | | | | | | | | | | | | | | | | | | | | |
| 2095 | 80 | | | | | | | | | | | | | | | | | | | | | | | | | | |
| TOTAL: | | \$ | 1,572,373 | \$ 6,079,844 | \$ 6,708,794 | \$ 2,255,691 | \$ - | \$ - | \$ 4,415,275 | \$ 1,878,165 | \$ - | \$ - | \$ - | \$ 2,347,707 | \$ - | \$ 8,620,738 | \$ 2,155,184 | \$ - | \$ - | \$ - | \$ - | \$ - | \$ - | \$ - | \$ - | \$ - | \$ - |
| TOTAL: | | \$ | 67,917,639 | | | | | | | | | | | | | | | | | | | | | | | | |

Gravina Island Access
TOTAL LIFE COST SUMMARY

Gravina TOTAL LIFE-TIME COSTS

Tolling

| YEAR | Number of Periods | \$1,500,000 Ferry Toll G4v and No-Action | \$2,000,000 Ferry Toll G2, G3 and G4 | \$250,000 C3-4 Bridge Toll | \$200,000 F3-1 Bridge Toll |
|------------------|-------------------|--|--------------------------------------|----------------------------|----------------------------|
| | Initial Cost: | \$ 1,500,000 | \$ 2,000,000 | \$ 250,000 | \$ 200,000 |
| 2015 | | | | | |
| 2016 | 1 | | | | |
| 2017 | 2 | | | | |
| 2018 | 3 | | | | |
| 2019 | 4 | | | | |
| 2020 | 5 | \$ 1,680,620 | \$ 2,240,826 | \$ 280,103 | \$ 224,083 |
| 2021 | 6 | 1,719,274 | 2,292,365 | 286,546 | 229,237 |
| 2022 | 7 | 1,758,817 | 2,345,090 | 293,136 | 234,509 |
| 2023 | 8 | 1,799,270 | 2,399,027 | 299,878 | 239,903 |
| 2024 | 9 | 1,840,653 | 2,454,204 | 306,776 | 245,420 |
| 2025 | 10 | 1,882,988 | 2,510,651 | 313,831 | 251,065 |
| 2026 | 11 | 1,926,297 | 2,568,396 | 321,049 | 256,840 |
| 2027 | 12 | 1,970,602 | 2,627,469 | 328,434 | 262,747 |
| 2028 | 13 | 2,015,926 | 2,687,901 | 335,988 | 268,790 |
| 2029 | 14 | 2,062,292 | 2,749,723 | 343,715 | 274,972 |
| 2030 | 15 | 2,109,725 | 2,812,966 | 351,621 | 281,297 |
| 2031 | 16 | 2,158,248 | 2,877,664 | 359,708 | 287,766 |
| 2032 | 17 | 2,207,888 | 2,943,851 | 367,981 | 294,385 |
| 2033 | 18 | 2,258,669 | 3,011,559 | 376,445 | 301,156 |
| 2034 | 19 | 2,310,619 | 3,080,825 | 385,103 | 308,083 |
| 2035 | 20 | 2,363,763 | 3,151,684 | 393,961 | 315,168 |
| 2036 | 21 | 2,418,130 | 3,224,173 | 403,022 | 322,417 |
| 2037 | 22 | 2,473,747 | 3,298,329 | 412,291 | 329,833 |
| 2038 | 23 | 2,530,643 | 3,374,190 | 421,774 | 337,419 |
| 2039 | 24 | 2,588,847 | 3,451,797 | 431,475 | 345,180 |
| 2040 | 25 | 2,648,391 | 3,531,188 | 441,398 | 353,119 |
| 2041 | 26 | 2,709,304 | 3,612,405 | 451,551 | 361,241 |
| 2042 | 27 | 2,771,618 | 3,695,491 | 461,936 | 369,549 |
| 2043 | 28 | 2,835,365 | 3,780,487 | 472,561 | 378,049 |
| 2044 | 29 | 2,900,579 | 3,867,438 | 483,430 | 386,744 |
| 2045 | 30 | 2,967,292 | 3,956,389 | 494,549 | 395,639 |
| 2046 | 31 | 3,035,540 | 4,047,386 | 505,923 | 404,739 |
| 2047 | 32 | 3,105,357 | 4,140,476 | 517,560 | 414,048 |
| 2048 | 33 | 3,176,780 | 4,235,707 | 529,463 | 423,571 |
| 2049 | 34 | 3,249,846 | 4,333,128 | 541,641 | 433,313 |
| 2050 | 35 | 3,324,593 | 4,432,790 | 554,099 | 443,279 |
| 2051 | 36 | 3,401,058 | 4,534,744 | 566,843 | 453,474 |
| 2052 | 37 | 3,479,283 | 4,639,043 | 579,880 | 463,904 |
| 2053 | 38 | 3,559,306 | 4,745,741 | 593,218 | 474,574 |
| 2054 | 39 | 3,641,170 | 4,854,894 | 606,862 | 485,489 |
| 2055 | 40 | 3,724,917 | 4,966,556 | 620,820 | 496,656 |
| 2056 | 41 | 3,810,590 | 5,080,787 | 635,098 | 508,079 |
| 2057 | 42 | 3,898,234 | 5,197,645 | 649,706 | 519,764 |
| 2058 | 43 | 3,987,893 | 5,317,191 | 664,649 | 531,719 |
| 2059 | 44 | 4,079,615 | 5,439,486 | 679,936 | 543,949 |
| 2060 | 45 | 4,173,446 | 5,564,594 | 695,574 | 556,459 |
| 2061 | 46 | 4,269,435 | 5,692,580 | 711,573 | 569,258 |
| 2062 | 47 | 4,367,632 | 5,823,509 | 727,939 | 582,351 |
| 2063 | 48 | 4,468,088 | 5,957,450 | 744,681 | 595,745 |
| 2064 | 49 | 4,570,854 | 6,094,471 | 761,809 | 609,447 |
| 2065 | 50 | 4,675,983 | 6,234,644 | 779,331 | 623,464 |
| 2066 | 51 | 4,783,531 | 6,378,041 | 797,255 | 637,804 |
| 2067 | 52 | 4,893,552 | 6,524,736 | 815,592 | 652,474 |
| 2068 | 53 | 5,006,104 | 6,674,805 | 834,351 | 667,480 |
| 2069 | 54 | 5,121,244 | 6,828,326 | 853,541 | 682,833 |
| 2070 | 55 | 5,239,033 | 6,985,377 | 873,172 | 698,538 |
| 2071 | 56 | 5,359,531 | 7,146,041 | 893,255 | 714,604 |
| 2072 | 57 | 5,482,800 | 7,310,400 | 913,800 | 731,040 |
| 2073 | 58 | 5,608,904 | 7,478,539 | 934,817 | 747,854 |
| 2074 | 59 | 5,737,909 | 7,650,545 | 956,318 | 765,055 |
| 2075 | 60 | 5,869,881 | 7,826,508 | 978,313 | 782,651 |
| 2076 | 61 | 6,004,888 | 8,006,517 | 1,000,815 | 800,652 |
| 2077 | 62 | 6,143,000 | 8,190,667 | 1,023,833 | 819,067 |
| 2078 | 63 | 6,284,289 | 8,379,053 | 1,047,382 | 837,905 |
| 2079 | 64 | 6,428,828 | 8,571,771 | 1,071,471 | 857,177 |
| 2080 | 65 | 6,576,691 | 8,768,922 | 1,096,115 | 876,892 |
| 2081 | 66 | 6,727,955 | 8,970,607 | 1,121,326 | 897,061 |
| 2082 | 67 | 6,882,698 | 9,176,931 | 1,147,116 | 917,693 |
| 2083 | 68 | 7,041,000 | 9,388,000 | 1,173,500 | 938,800 |
| 2084 | 69 | 7,202,943 | 9,603,924 | 1,200,491 | 960,392 |
| 2085 | 70 | 7,368,611 | 9,824,814 | 1,228,102 | 982,481 |
| 2086 | 71 | 7,538,089 | 10,050,785 | 1,256,348 | 1,005,079 |
| 2087 | 72 | 7,711,465 | 10,281,953 | 1,285,244 | 1,028,195 |
| 2088 | 73 | 7,888,829 | 10,518,438 | 1,314,805 | 1,051,844 |
| 2089 | 74 | 8,070,272 | 10,760,362 | 1,345,045 | 1,076,036 |
| 2090 | 75 | 8,255,888 | 11,007,851 | 1,375,981 | 1,100,785 |
| 2091 | 76 | 8,445,773 | 11,261,031 | 1,407,629 | 1,126,103 |
| 2092 | 77 | 8,640,026 | 11,520,035 | 1,440,004 | 1,152,003 |
| 2093 | 78 | 8,838,747 | 11,784,996 | 1,473,124 | 1,178,500 |
| 2094 | 79 | 9,042,038 | 12,056,051 | 1,507,006 | 1,205,605 |
| 2095 | 80 | 9,250,005 | 12,333,340 | 1,541,667 | 1,233,334 |
| SUBTOTAL: | | \$ 338,353,707 | \$ 451,138,275 | \$ 56,392,284 | \$ 45,113,828 |

| YEAR | ALT C3-4 | | ALT F3-1 | | G2 | | G3 | | G4 | | G4v | | Wait & Dock & Berth | | | | | No Action | | |
|------|---------------|-------------|---------------|-------------|---------------|-------------|---------------|-------------|---------------|------------|---------------|------------|---------------------|------------|-------------|-------------|-------------|------------|---------------|-------------|
| | ANNUAL TOTALS | TOTALS | ANNUAL TOTALS | TOTALS | ANNUAL TOTALS | TOTALS | ANNUAL TOTALS | TOTALS | ANNUAL TOTALS | TOTALS | ANNUAL TOTALS | TOTALS | ANNUAL TOTALS | TOTALS | w/ G2 | w/ G3 | w/ G4 | w/ G4v | ANNUAL TOTALS | TOTALS |
| 5 | 250,369,138 | | 309,408,455 | | 94,529,786 | | 82,239,822 | | 73,597,990 | | 29,288,644 | | 14,372,215 | | | | | | 3,732,400 | |
| 6 | 225,085 | 250,594,222 | 217,234 | 309,625,689 | 3,858,575 | 98,388,361 | 3,845,520 | 86,085,342 | 3,839,000 | 77,436,989 | 3,839,000 | 33,127,644 | 11,462 | 14,383,677 | 112,772,038 | 100,469,019 | 91,820,666 | 47,511,321 | 3,818,200 | 7,550,600 |
| 7 | 277,119 | 250,871,341 | 315,989 | 309,941,678 | 4,134,884 | 102,523,245 | 4,121,529 | 90,206,871 | 4,114,859 | 81,551,848 | 4,021,056 | 37,148,699 | 58,627 | 14,442,304 | 116,965,549 | 104,649,176 | 95,994,153 | 51,591,003 | 3,999,778 | 11,550,378 |
| 8 | 235,467 | 251,106,808 | 227,251 | 310,168,930 | 4,038,020 | 106,561,265 | 4,024,358 | 94,231,229 | 4,017,534 | 85,569,382 | 4,017,534 | 41,166,233 | 11,995 | 14,454,299 | 121,015,564 | 108,685,528 | 100,023,682 | 55,620,533 | 3,995,767 | 15,546,144 |
| 9 | 289,922 | 251,396,730 | 330,602 | 310,499,531 | 4,327,186 | 110,888,451 | 4,313,209 | 98,544,438 | 4,306,229 | 89,875,611 | 4,208,061 | 45,374,294 | 61,355 | 14,515,655 | 125,404,106 | 113,060,093 | 104,391,266 | 59,889,949 | 4,185,793 | 19,731,937 |
| 10 | 1,337,975 | 252,734,706 | 2,584,697 | 313,084,229 | 6,439,648 | 117,328,099 | 5,710,959 | 104,255,397 | 5,086,363 | 94,961,975 | 4,898,065 | 50,272,359 | 125,533 | 14,641,187 | 131,969,286 | 118,896,584 | 109,603,162 | 64,913,546 | 4,750,362 | 24,482,299 |
| 11 | 303,322 | 253,038,027 | | | | | | | | | | | | | | | | | 4,380,463 | 28,862,762 |
| 12 | 257,704 | 253,295,731 | | | | | | | | | | | | | | | | | 4,376,070 | 33,238,832 |
| 13 | 317,344 | 253,613,075 | | | | | | | | | | | | | | | | | 4,584,191 | 37,823,023 |
| 14 | 269,604 | 253,882,678 | | | | | | | | | | | | | | | | | 4,579,594 | 42,402,617 |
| 15 | 3,810,945 | 257,693,623 | | | | | | | | | | | | | | | | | 5,504,975 | 47,907,592 |
| 16 | 282,057 | 257,975,680 | | | | | | | | | | | | | | | | | 4,792,586 | 52,700,178 |
| 17 | 347,376 | 258,323,056 | | | | | | | | | | | | | | | | | 5,020,525 | 57,720,703 |
| 18 | 295,089 | 258,618,145 | | | | | | | | | | | | | | | | | 5,015,489 | 62,736,192 |
| 19 | 363,448 | 258,981,593 | | | | | | | | | | | | | | | | | 5,254,033 | 67,990,226 |
| 20 | 1,788,592 | 260,770,185 | | | | | | | | | | | | | | | | | 6,555,093 | 74,545,319 |
| 21 | 380,267 | 261,150,452 | | | | | | | | | | | | | | | | | 5,498,407 | 80,043,726 |
| 22 | 323,001 | 261,473,454 | | | | | | | | | | | | | | | | | 5,492,892 | 85,536,618 |
| 23 | 397,869 | 261,871,322 | | | | | | | | | | | | | | | | | 5,754,151 | 91,290,768 |
| 24 | 337,939 | 262,209,261 | | | | | | | | | | | | | | | | | 5,748,379 | 97,039,147 |
| 25 | 4,783,474 | 266,992,735 | | | | | | | | | | | | | | | | | 6,910,033 | 103,949,180 |
| 26 | 353,570 | 267,346,305 | | | | | | | | | | | | | | | | | 6,015,753 | 109,964,933 |
| 27 | 435,567 | 267,781,872 | | | | | | | | | | | | | | | | | 6,301,889 | 116,266,823 |
| 28 | 369,930 | 268,151,802 | | | | | | | | | | | | | | | | | 6,295,568 | 122,562,391 |
| 29 | 455,741 | 268,607,543 | | | | | | | | | | | | | | | | | 6,585,018 | 129,157,408 |
| 30 | 4,876,778 | 273,484,321 | | | | | | | | | | | | | | | | | 7,484,687 | 136,642,096 |
| 31 | 476,854 | 273,981,175 | | | | | | | | | | | | | | | | | 6,901,785 | 143,543,881 |
| 32 | 404,968 | 274,386,141 | | | | | | | | | | | | | | | | | 6,894,861 | 150,438,742 |
| 33 | 498,949 | 274,865,089 | | | | | | | | | | | | | | | | | 7,222,825 | 157,661,567 |
| 34 | 423,716 | 275,288,806 | | | | | | | | | | | | | | | | | 7,215,579 | 164,877,147 |
| 35 | 6,158,315 | 281,447,121 | | | | | | | | | | | | | | | | | 9,506,954 | 174,384,101 |
| 36 | 443,338 | 281,890,459 | | | | | | | | | | | | | | | | | 7,551,220 | 181,935,321 |
| 37 | 546,270 | 282,436,729 | | | | | | | | | | | | | | | | | 7,910,414 | 189,845,735 |
| 38 | 463,873 | 282,900,602 | | | | | | | | | | | | | | | | | 7,902,478 | 197,748,213 |
| 39 | 571,594 | 283,472,196 | | | | | | | | | | | | | | | | | 8,278,384 | 206,026,597 |
| 40 | 2,644,844 | 286,117,041 | | | | | | | | | | | | | | | | | 52,852,575 | 258,879,172 |
| 41 | 598,096 | 286,715,137 | | | | | | | | | | | | | | | | | 8,663,476 | 267,542,648 |
| 42 | 507,854 | 287,222,991 | | | | | | | | | | | | | | | | | 8,654,784 | 276,197,432 |
| 43 | 625,832 | 287,848,822 | | | | | | | | | | | | | | | | | 9,066,485 | 285,263,917 |
| 44 | 531,390 | 288,380,212 | | | | | | | | | | | | | | | | | 9,057,389 | 294,321,306 |
| 45 | 7,536,850 | 295,917,062 | | | | | | | | | | | | | | | | | 10,887,971 | 305,209,277 |
| 46 | 556,021 | 296,473,083 | | | | | | | | | | | | | | | | | 9,478,726 | 314,688,003 |
| 47 | 685,233 | 297,158,316 | | | | | | | | | | | | | | | | | 9,929,631 | 324,617,634 |
| 48 | 581,798 | 297,740,114 | | | | | | | | | | | | | | | | | 9,919,668 | 334,537,302 |
| 49 | 717,022 | 298,457,136 | | | | | | | | | | | | | | | | | 10,391,552 | 344,928,854 |
| 50 | 3,536,233 | 301,993,369 | | | | | | | | | | | | | | | | | 12,965,300 | 357,894,154 |
| 51 | 750,290 | 302,743,659 | | | | | | | | | | | | | | | | | 10,874,967 | 368,769,121 |
| 52 | 637,006 | 303,380,665 | | | | | | | | | | | | | | | | | 10,864,055 | 379,633,176 |
| 53 | 785,106 | 304,165,771 | | | | | | | | | | | | | | | | | 11,380,873 | 391,014,049 |
| 54 | 666,550 | 304,832,321 | | | | | | | | | | | | | | | | | 11,369,454 | 402,383,503 |
| 55 | 14,350,446 | 319,182,767 | | | | | | | | | | | | | | | | | 13,667,430 | 416,050,933 |
| 56 | 697,469 | 319,880,236 | | | | | | | | | | | | | | | | | 11,898,368 | 427,949,301 |
| 57 | 859,672 | 320,739,908 | | | | | | | | | | | | | | | | | 12,464,400 | 440,413,701 |
| 58 | 729,827 | 321,469,735 | | | | | | | | | | | | | | | | | 12,451,892 | 452,865,593 |
| 59 | 899,577 | 322,369,312 | | | | | | | | | | | | | | | | | 13,044,261 | 465,909,854 |
| 60 | 4,166,691 | 326,536,003 | | | | | | | | | | | | | | | | | 14,804,199 | 480,714,053 |
| 61 | 941,338 | 327,477,341 | | | | | | | | | | | | | | | | | 13,651,102 | 494,365,155 |
| 62 | 799,128 | 328,276,469 | | | | | | | | | | | | | | | | | 13,637,403 | 508,002,558 |
| 63 | 985,042 | 329,261,511 | | | | | | | | | | | | | | | | | 14,286,179 | 522,288,737 |
| 64 | 836,215 | 330,097,726 | | | | | | | | | | | | | | | | | 14,271,843 | 536,560,579 |
| 65 | 12,180,367 | 342,278,093 | | | | | | | | | | | | | | | | | 18,804,625 | 555,365,205 |
| 66 | 875,028 | 343,153,121 | | | | | | | | | | | | | | | | | 14,935,801 | 570,301,006 |
| 67 | 1,078,645 | 344,231,765 | | | | | | | | | | | | | | | | | 15,646,355 | 585,947,361 |
| 68 | 915,646 | 345,147,412 | | | | | | | | | | | | | | | | | 15,630,653 | 601,578,014 |
| 69 | 1,128,737 | 346,276,149 | | | | | | | | | | | | | | | | | 16,374,288 | 617,952,282 |
| 70 | 5,230,028 | 351,506,176 | | | | | | | | | | | | | | | | | 18,583,562 | 636,535,845 |
| 71 | 1,181,160 | 352,687,336 | | | | | | | | | | | | | | | | | 17,136,050 | 653,671,895 |
| 72 | 1,002,640 | 353,689,976 | | | | | | | | | | | | | | | | | 17,118,854 | 670,790,749 |
| 73 | 1,236,022 | 354,925,998 | | | | | | | | | | | | | | | | | 17,933,277 | 688,724,026 |
| 74 | 1,049,195 | 355,975,193 | | | | | | | | | | | | | | | | | 17,915,280 | 706,639,306 |
| 75 | 14,907,357 | 370,882,549 | | | | | | | | | | | | | | | | | 117,855,219 | 824,494,525 |
| 76 | 1,097,917 | 371,980,466 | | | | | | | | | | | | | | | | | 117,855,219 | 843,243,289 |
| 77 | 1,353,521 | 373,333,987 | | | | | | | | | | | | | | | | | 117,855,219 | 862,884,027 |
| 78 | 1,148,905 | 374,482,892 | | | | | | | | | | | | | | | | | 117,855,219 | 882,505,561 |
| 79 | 1,416,403 | 375,899,295 | | | | | | | | | | | | | | | | | 117,855,219 | 903,059,561 |
| 80 | 15,626,685 | 391,525,980 | | | | | | | | | | | | | | | | | 25,645,878 | 928,705,440 |
| | 391,525,980 | | 576,608,860 | | 1,261,921,427 | | 1,194,737,179 | | 1,139,054,990 | | 982,293,353 | | 67,917,639 | | | | | | 928,705,440 | |

